

MMS3000-GP

Owner's Manual

Revision 280201

Trademark Notice

Multi Measurement System™, MMS™, GP™, GP8™, GP4™, MM3000-GP8™, MM3000-GP4™, MAST™, and **PROFLASH™** are trademarks of COMMTEST INSTRUMENTS Ltd.

Other trademarks and registered trademarks belong to their respective owners.

©COPYRIGHT – 2001 COMMTEST INSTRUMENTS Ltd.

All Rights Reserved

CONTENTS

INTRODUCTION	7
1.1 STANDARD FEATURES	8
1.2 STANDARD KIT ITEMS	9
1.3 SUMMARY OF PARTS	10
1.4 PRECAUTIONS	12
1.5 USING THIS MANUAL	14
1.5.1 Warnings	14
1.5.2 Names	14
1.5.3 Instruction Sequences	15
1.5.4 Instruction Types	15
1.6 QUICK START GUIDE	16
1.6.1 Taking a Recording	16
1.6.2 Taking another Recording	16
1.6.3 Recording Playback	17
1.6.4 Changing the Default Setup	17
1.6.5 Recording Data at Time Intervals	18
1.6.6 Recording after an Alarm Condition has occurred	18
1.6.7 Recording Data before an Alarm Condition	19
BASIC OPERATION	21
2.1 GENERAL	22
2.1.1 Powering Up	22
2.1.2 Accessing Main Menu	22
2.1.3 Selecting a Main Menu Item	23
2.1.4 Selecting an Option	23
2.1.5 Editing Names	25
2.1.6 Editing Numerical Values	28
2.2 SETTING UP INPUTS	29
2.2.1 Channel Selection & Setup	29
2.2.2 Wiring Sensors	30
2.2.3 Internal Power to Sensor	30
2.2.4 Matching Inputs to Sensors	31
2.2.5 Modifying the Input boxes	32
2.2.6 Modifying the Output boxes	34

2.2.7 Modifying the Units _____	34
2.3 SETTING UP CHANNELS _____	35
2.3.1 Setting Up Your Recording (The Trigger Menu) _____	35
2.3.2 Setting Display Options _____	41
2.3.3 Graph Controls _____	42
2.4 RECORDING DATA _____	44
2.4.1 Setting Up the Filename _____	44
2.4.2 Choosing a Folder _____	44
2.4.3 Starting a Recording _____	45
2.4.4 Auto-Repeating Recordings _____	45
2.4.5 Chained Recordings _____	46
2.5 PLAYING BACK _____	47
2.6 FILE UTILITIES _____	48
2.7 OUTPUTTING SAMPLES FROM RS232 _____	49
<i>UTILITIES</i> _____	51
3.1 RESETTING THE INSTRUMENT _____	52
3.2 ADJUSTING LCD _____	53
3.2.1 Adjusting Contrast _____	53
3.2.2 Turning Backlight On _____	53
3.3 SETTING CLOCK _____	54
3.3.1 Checking Date and Time _____	54
3.3.2 Setting Date and Time _____	54
3.4 MANAGING BATTERY _____	55
3.4.1 Instrument Battery _____	55
3.4.2 Checking Battery Capacity _____	56
3.4.3 Charging Powered-up instrument _____	56
3.4.4 Charging Powered-down instrument _____	56
3.4.5 Reconditioning Battery Pack _____	57
3.4.6 Power Saver _____	57
3.4.7 Replacing Battery Pack _____	58
3.5 ERASING MEMORY _____	59
3.6 TROUBLESHOOTING _____	60
3.6.1 Power Problems _____	60
3.6.2 Data Problems _____	60
3.6.3 Data-Transfer Problems _____	61

3.6.4 Other Problems _____	61
ANALYSIS SOFTWARE _____	63
4.1 INSTALLING MAS-3000 _____	64
4.1.1 License Agreement _____	64
4.1.2 PC System Requirements _____	64
4.1.3 Installing MAS on PC _____	65
4.2 STARTING UP MAS _____	66
4.2.1 Starting up _____	66
4.2.2 Configuring PC COM port _____	66
4.3 TRANSFERRING DATA TO THE PC _____	67
4.4 MANAGING DATA _____	68
4.4.1 Opening a File _____	68
4.4.2 Merging Two Files _____	68
4.4.3 Using the Navigator _____	68
4.4.4 Deleting Data from a Folder _____	68
4.4.5 Editing Recording Details _____	69
4.4.6 Viewing and Printing Data _____	69
4.4.7 Exporting data _____	70
4.5 CALCULATING DATA _____	71
4.6 PLOTTING DATA _____	72
4.6.1 Plotting Single and Individual Charts _____	72
4.6.2 Zooming & Panning _____	73
4.6.3 Printing Charts _____	73
4.6.4 Reading and Comparing Values _____	74
4.6.5 Plotting Waterfall Charts _____	76
4.7 UPGRADING FIRMWARE _____	77
Appendix SPECIFICATIONS _____	79
Appendix SENSOR WIRING _____	81
6.1 TWO-WIRE 4-20mA SENSORS _____	82
6.1.1 Two-Wire 4-20mA Sensors _____	82
6.1.2 Connecting Sensors using External Power Supply _____	83
6.2 FOUR-WIRE 4-20mA SENSORS _____	84
6.2.1 Connecting Sensors using Internal Power Supply _____	84
6.2.2 Connecting Sensors using External Power Supply _____	85

Appendix MAS-3000 MATH	87
7.1 FUNCTIONS	88
7.1.1 Mathematical Functions	88
7.1.2 Iterative Functions	90
7.1.3 Logical Functions	90
7.1.4 Conditional Functions	91
7.1.5 Date and Time Functions	91
7.2 OPERATORS	92
7.2.1 Logical Operators	92
7.2.2 Arithmetic Operators	92



INTRODUCTION

Thank you for purchasing the MMS3000-GP4 or MMS3000-GP8.

The GP4 allows up to four channels of measurements using sensors that output 4-20mA signals.

The GP8 allows up to eight channels of measurements using sensors that output 4-20mA signals.

Collected data can be transferred to a PC where it can be analyzed in detail using the MAS-3000 Windows[®] based software supplied in the kit.

This manual has been formatted to allow you to quickly learn how to use your instrument. Please keep this manual for future reference and read it before operating your instrument.

1.1 STANDARD FEATURES

- GP4 allows up to four channels of measurements using sensors that output 4-20mA signals
- GP8 allows up to eight channels of measurements using sensors that output 4-20mA signals
- 24-bit A/D converter providing high-precision measurements
- 512 kB non-volatile memory capable of storing up to 100,000 sample points
- Time and date stamped recordings
- Temperature-compensated graphical LCD (liquid-crystal display) with 240x128 pixels
- Electro-luminescent LCD backlight
- Built-in battery charger and conditioner
- 1500mAh Ni-Cad (Nickel-Cadmium) battery pack
- Upgradeable MMS3000 firmware
- RS232 interface to communicate with a PC (personal computer)
- Windows® based Measurement Analysis Software (MAS)

1.2 STANDARD KIT ITEMS



MMS3000 Series instrument with protective boot and strap

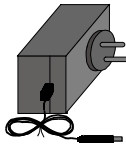

AC/DC power transformer
13.5± 1.5VDC, 1A output

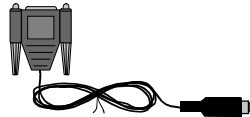

Data-transfer cable with DB9 connector



Quality assurance card

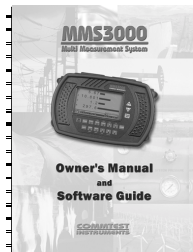

MMS3000 Series
Owner's Manual and Software Guide



MAS-3000
analysis software CD

1.3 SUMMARY OF PARTS

MMS3000-GP4

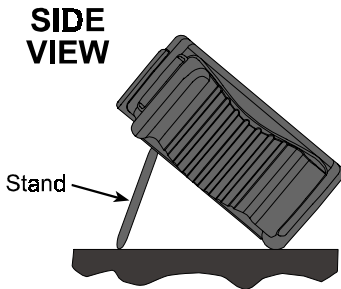
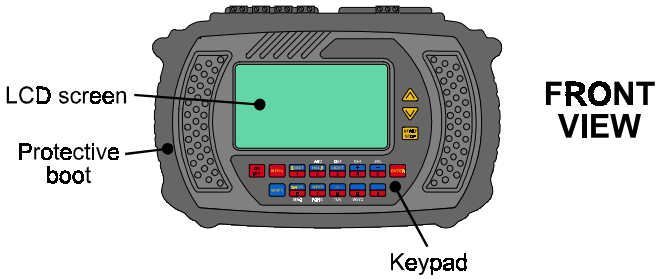
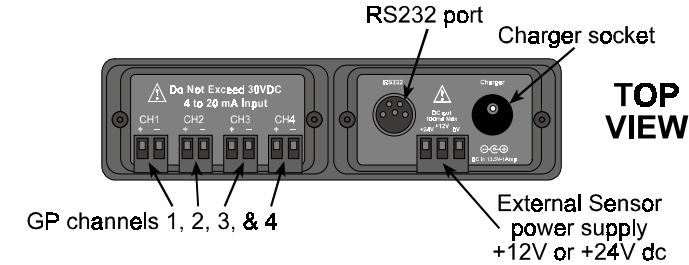

BACK VIEW (stand removed)

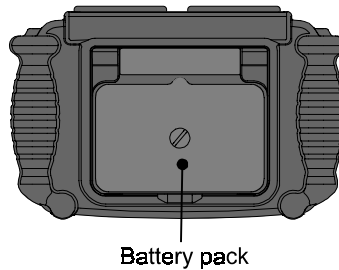

MMS3000-GP8

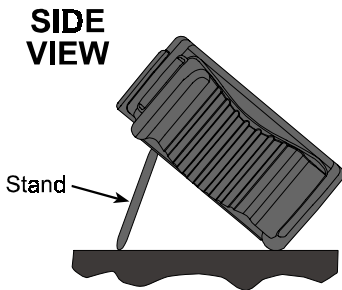
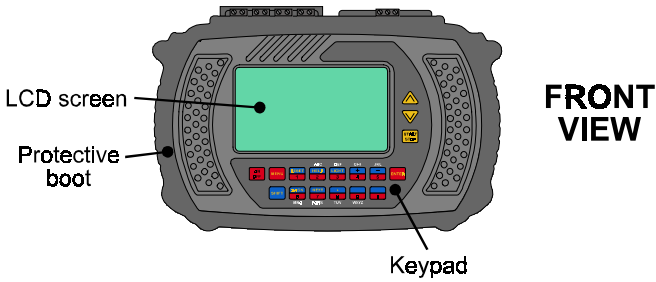
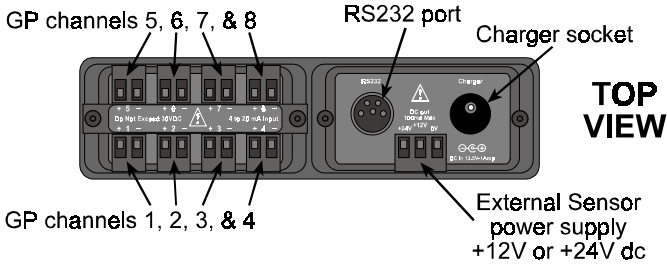

BACK VIEW (stand removed)

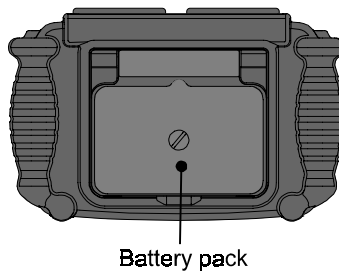

1.4 PRECAUTIONS

WARNING: Please read and understand this section fully before operating your instrument. Not heeding the warnings or recommendations could result in data loss, data inaccuracy, damage to the instrument, or injury to yourself.

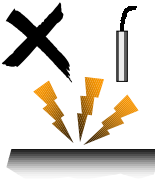

WARNING: To avoid electrical shock, do not connect any sensor to a high voltage i.e. a voltage that exceeds 50VDC or 32VAC or the “safety extra low voltage” (SELV) defined by your local power authority.

WARNING: Ensure the data-transfer cable and bootstrap cannot be entangled with any moving or rotating machinery.

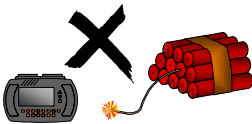
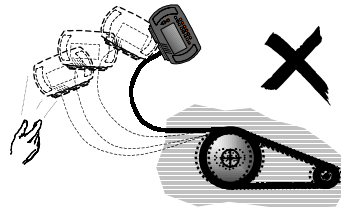

WARNING: Do not operate the instrument in an explosive environment.

WARNING: Do not detach the battery pack from the instrument for more than 2 hours as data and settings may be lost.



WARNING: Transfer data stored in the instrument to a PC before **PROFLASHING** the instrument with new firmware – reprogramming the instrument erases all data stored in the instrument (see section 4.7).

WARNING: Charge the battery pack up to at least 30% capacity before taking a recording. If using the instrument for 4 hours or more, first ensure that the battery pack is fully charged.



WARNING: Constantly charging the battery when it is not fully drained will create a "Memory" effect and eventually shorten the amount of charge that the battery can hold. Please read **3.4 Managing Battery** to learn how to prevent this.



WARNING: Do not expose the instrument to large impacts or pressure.

WARNING: Do not use alcohol or any organic solvent to clean the instrument.



WARNING: Do not expose the instrument to wet conditions or store it in a damp place where the relative humidity exceeds 80% RH.

WARNING: Do not place the instrument in a hot place where the temperature exceeds 140°F (60°C). Otherwise, the battery pack will degrade.



WARNING: Ensure that the battery pack is securely fastened – but not over-tightened – to the instrument before operating the instrument.

WARNING: If the instrument malfunctions, return it to an authorized dealer. Do not try to repair it yourself, as this will invalidate the warranty.

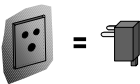

WARNING: Use only an approved power transformer and ensure its voltage and frequency rating matches that of your mains AC power.

1.5.3 Instruction Sequences

The ▶ symbol is used to indicate the sequence of menu selections.

Instruction	Meaning
Click <i>File</i> ▶ <i>Save</i> .	Select the <i>File</i> menu and then select <i>Save</i> .

1.5.4 Instruction Types

The word “press” refers to key presses or menu selections on the instrument.

The word “click” refers to menu selections on the PC, and “push” refers to key presses on the PC keyboard.

Instruction	Meaning
Click <i>File</i> ▶ <i>Export</i> .	Select <i>File</i> and then <i>Export</i> in MAS-3000 software.
Push the Esc key.	Push the Esc key on the PC keyboard.





Some operating instructions are illustrated with examples. Such instructions are marked with the word **EXAMPLE**.

1.6 QUICK START GUIDE

This section of the manual is provided so you can get up and running with your instrument without having to read the whole manual. Please read section **1.4 Precautions** before continuing.

1.6.1 Taking a Recording

To perform a simple recording;

- Press   *Trig.*
- Press  *Manual.*
- You have now setup a *Manual* trigger recording.
- Press  to begin the recording.
- Press  to end the recording.

1.6.2 Taking another Recording

To perform a yet another recording after the first;









- Press  to begin the next recording.

Note: Recordings are sequentially numbered unless manually renamed.

- Press  to end the recording.

1.6.3 Recording Playback



To review any of the recordings made using the instrument;

- Press   *File*.
- Press  *Examine Files...*
- Select the recording to be reviewed using  and .
- Press  to confirm the selection and commence *Playback*.
- To end the *Playback*, press   *Display*,  *Exit Playback*.

Note: Refer to section **2.5 Playing Back** for more details.

1.6.4 Changing the Default Setup

1. To change the *Sample Period* or the *Recording period*;



- Press   *Trig*.
- Press  *Record for...* to edit the *Recording period*.

OR

- Press  *Sample Period...* to edit the *Sample period*.

Note: Refer to section **2.3 Setting up Channels** for more details.

2. To match your 4-20mA sensors to the instrument so it displays in the units of the sensor instead of mA;





- Press   *Sys* and select  *Setup Inputs...*

Note: Refer to section **2.2 Setting up Inputs** for more details.

1.6.5 Recording Data at Time Intervals

An example of this type of recording may be recording the Relative Humidity in an art gallery every hour. You would then log one sample of data every hour and have channels with sensors recording the %RH, Temperature and light levels.

To make the instrument record data every specified time interval and then power down and wait for the next recording time;



- Press   *Trig* and select  *Timer Based...*
- Change the *Recording* and *Sampling periods* to suit.
- Change the *After Recording:* option to *Power Down*.
- Press  to accept the changes and then press  to begin the recording.

Note: Refer to section **2.3.1 Setting Up Your Recording (The Trigger Menu)** for more details.

1.6.6 Recording after an Alarm Condition has occurred

An example of this type of recording would be to record the level of a lake after it begins to flood.

To make the instrument start to record data after an alarm event;

- Press   *Trig* and select  *Level Based...*
- Select the channel on which to place the alarm level.
- Select the *Trigger* type to be used.
- Enter the range(s) of the *Trigger* that would cause it to generate the alarm.

- Press **MENU** to accept the changes and then press **START STOP** to place the instrument into *Waiting for Trigger* mode.

Note: Ensure that the channel that you have set the alarm level on is actually enabled.

Note: Refer to section **2.3.1 Setting Up Your Recording (The Trigger Menu)** for more details.

1.6.7 Recording Data before an Alarm Condition

An example of this type of recording would be to record data 60 minutes before an earth quake occurs.

To make the instrument record data before an alarm is triggered;

- Setup the channel(s) required with the alarm condition as above.
- Press **MENU** **LIGHT** **Trig** and select **LIGHT** **Pre-Trig...**
- Enter the time period required to log data before the alarm event and press **MENU** to accept this value. In the example *60 minutes* would be entered.
- Press **START STOP** and the instrument will begin logging data. This allows it to store data for the specified time before an alarm event occurs.

Note: If an alarm event triggers the instrument before it has stored the specified *Pre-Trig* data then the recording will begin at the current point in time. This means it is possible to have a recording that does not contain the total amount of *Pre-Trig* data.

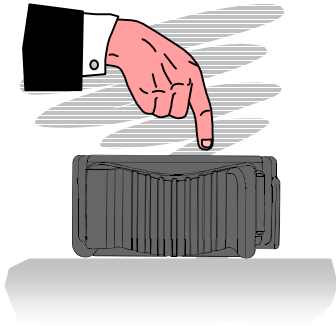

BASIC OPERATION



This section outlines the procedure for performing basic operations on your instrument. You will learn to:

- use the instrument menu system;
- record data; and
- playback recorded data.

WARNING: Read section 1.4 before operating your instrument.

2.1 GENERAL



2.1.1 Powering Up*

- Press . The *Initialization* screen is displayed.
- Press . Measurement begins and the screen displays data that is being measured (using previous settings).
- To power down, press  and follow on-screen instructions. If the instrument does not respond to any key press, reset it (see section 3.1).

2.1.2 Accessing Main Menu

To perform instrument operations, you need to access the main menu. To access the main menu:

- Press .



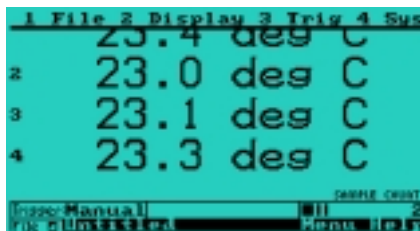

You can alternatively press . The main menu is displayed at the top of the screen and consists of four items: *File*, *Display*, *Trig(ger)*, and *Sys(tem)*. To cancel the main menu, press  again.



* Every time the instrument is powered up, the power saver (a power-saving feature) is automatically turned on. See section 3.4.6 for more details.

2.1.3 Selecting a Main Menu Item

- Press the number preceding the menu item.

Alternatively, press  and  to cycle to the menu item then press  or .





EXAMPLE: to select the main menu item *Trig*, press .





The drop down menu above shows the available options for the *Trigger* menu. To cancel a dropdown menu, press .

2.1.4 Selecting an Option

The procedure for selecting an option in a dropdown menu is similar to selecting a main menu item i.e.

- Press the number preceding the option, or press  and  to cycle to the option and then press  or .

Selected options, where appropriate, are checked (✓). Selecting options with names ending with “...” brings up windows that provide more options. These options, and any further options they provide, can be selected in the same manner. Most windows have self-explanatory instructions. If more than one window is displayed, the topmost is the one active. To cancel a window, press .

EXAMPLE: to select *Level Based...* in the example below, press 



2.1.5 Editing Names

To enter characters in the text editing window:

- Select *Display* from the main menu and then select *Edit Channel Units* or *Edit Channel Names*.
- Press the key with the character you want until it appears above the flashing cursor.



e.g. to enter the letter B, press  until the B is displayed.







- The cursor advances automatically when you press the next key.



e.g. if the next letter you want to enter is E, press  until E is displayed.



- If the next letter of the word is on the same key just pressed, press   to advance the cursor position.



e.g. press   then press key  until the letter D appears. (The cursor can be moved backwards by pressing  ).



- More editing options (and their shortcut keys) are available by pressing  .

Note:  and  can be used to enter the space character.

Libraries are available to make entering text easier.

- Press   to access the library categories.

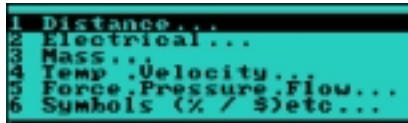



























- Pressing   will show the last text library selected.











Table of Short Cut Keys

Short Cut Key	Meaning
 	Clear all text
   or  	Move cursor forward
   or  	Move cursor back
 	Insert a space
 	Delete character
  or  (press twice)	Can be used to enter a space
 	Text Library
 	Last Text Library

To toggle from upper to lower case press  and choose the desired case from the pop-up menu.

Folder, Recording and Channel names can have a maximum of 16 characters. Unit Names can have a maximum of 8 characters.

2.1.6 Editing Numerical Values

- Select the numeric field to be edited (using the normal option selection procedure outlined in section 2.1.4).
- Press the appropriate digit keys to enter the desired value. Enter a decimal point by pressing  .
- To make the number negative/positive press  .
- Clear floating point numbers by pressing  . Non-floating point numbers can sometimes be incremented or decremented by pressing  or , e.g. This is possible when setting the SAMPLING PERIOD.

2.2 SETTING UP INPUTS

In order for the instrument to interpret the output levels of a sensor, you need to match the sensor's output current to the value you would like displayed. The manufacturer of the sensor usually provides this information.

2.2.1 Channel Selection & Setup

The instrument needs to know what type of sensor is attached to each input channel. You must set up the input channels one at a time.

- Access the main menu (see section 2.1.2).
- Press **Sys** ▶ *Setup Inputs...* to display the “Setup Channel Input” window.



- Press **ENTER** or **START STOP** to display the channel drop down menu.

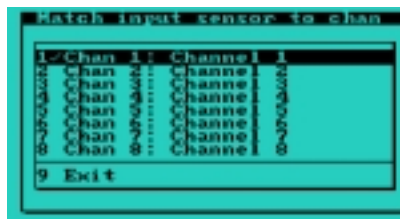

- Select the channel you would like to setup.

Note: Channels can be named by choosing “*Edit/Names*” from the “*Display*” menu on the main menu bar (see section 2.1.2). These names appear when downloading to a PC.

2.2.2 Wiring Sensors

Two-wire or four-wire sensors that output 4-20mA signals can be used. A power source is required to produce the 4-20mA output signal. For information on how sensors should be wired to the instrument, see **Appendix Sensor Wiring**.

WARNING: To avoid electrical shock, do not connect any sensor to a high voltage i.e. a voltage that exceeds 50VDC or 32VAC or the “safety extra low voltage” (SELV) defined by your local power authority.

2.2.3 Internal Power to Sensor

The instrument can generate an internal 12 or 24 volt dc supply.

To activate the internal power supply;

- Press **MF** **+** **Sys** and then **Power** **2** **Power to Sensors**. A tick will appear next to *Power to Sensors* to indicate that it is enabled.

CAUTION: When the *Power to Sensors* is activated it draws more power from the battery than normal.

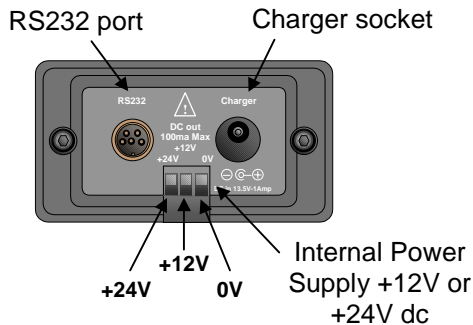

2.2.4 Matching Inputs to Sensors

You need to match the inputs from the sensor to the values you would like displayed, otherwise all recordings will be only in mA.

EXAMPLE: If you have a 4mA - 20mA pressure sensor connected to channel 1 that produces:

4mA at 10 psi
and 20mA at 100 psi

then setup the instrument as follows:

- By setting the sensor endpoints, the instrument can display correct readings over the entire range.

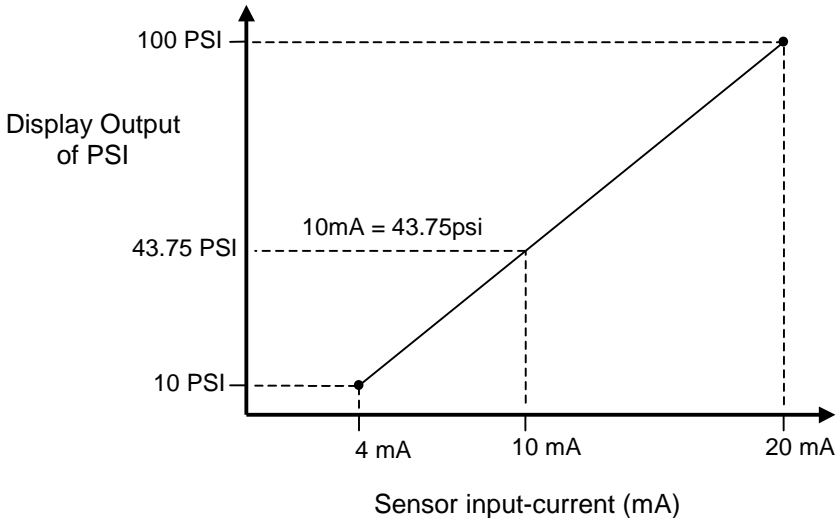

2.2.5 Modifying the Input boxes

In this example we will setup the channel to match the following sensor inputs:

Input	Output	Units
4.000mA	10	PSI
20.000mA	100	PSI

- From the main menu, press Sys ▶ *Setup Inputs...* and select the channel to be setup.
- Use the ▲ or ▼ arrows to move the flashing cursor to the input box you wish to edit.
- Press **ENTER** or **START STOP** to display a list of edit options.



Resetting the Input Values:

- Select "Set to 4mA & 20mA" to reset the input current values to the default settings.

Editing the Input Value:

- Select "Edit Current..." to enter the sensor input current in mA.
- Press **ENTER** or **START STOP** to accept the entered value.

Sampling the Input value:

It is also possible to set the input boxes by sampling the voltage or temperature being monitored by the instrument.

This is very useful if you know what you're measuring, but do not know what current your input sensor is providing.

e.g.

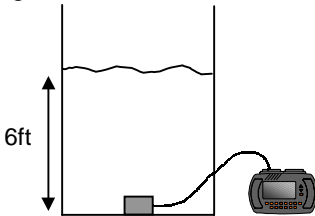

You have a sensor that can measure the depth of water based on pressure readings but have no data that relates the sensor output current to the actual depth. However, you do know that the present depth = 6ft.







- To match the input box follow the steps from the previous example, but choose “*Sample Input Current*”.







- The input box will update with the sample taken being displayed in the selected input box.
- If you are not happy with the sampled value keep selecting “*Sample Input Current*” until you are, then press  to close the options menu.

- Note:**
- The first input box value must be smaller than the second input box value.
 - The valid range for the inputs are 3.2mA to 24mA.
 - Input box readings must be more than 1mA apart.

2.2.6 Modifying the Output boxes

- Use the  or  arrows to move the flashing cursor to the output box to be altered.
- Press  or  to edit the value in this box. The box will become highlighted, with its previous value cleared. Now enter in the value, and press  or  to accept this value.





- Now press  arrow to select the next output box (The cursor should flash beneath it).
- Press  to begin editing. Type in the number 10.0, and press  or  to accept this value.



- Note:** Output box values
- Can be positive or negative.
 - Can contain decimal places.
 - Can be in any order (i.e. box 1 can be greater than box 2).

2.2.7 Modifying the Units





- To change the units (e.g. to mm), press  arrow until two flashing cursors appear below the unit boxes.
- Press  to begin editing the unit. The “Enter Channel Unit” window will appear (see section 2.1.5).

2.3 SETTING UP CHANNELS

2.3.1 Setting Up Your Recording (The Trigger Menu)

Most of the important information involved in your recording is entered under the trigger menu. Trigger Type, which Channels are enabled, Sample Period, and Recording length/time.



Below are examples of all the trigger menu items. Each item can be configured by following the pop-up menus as per previous sections. Timer and level based trigger options can be selected by the  or  arrows and pressing  or .

The Trigger Type (how recordings are started).

There are three main types of trigger available:

- ***Manual Trigger***
- ***Time Based Trigger***
- ***Level Based Trigger***

3 Level Based Trigger - data is recorded if a sensor reaches a specified level.

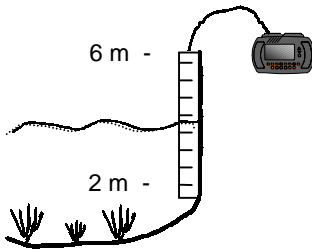

e.g. Trigger if lake level is above 6m or below 2m.



Available level trigger options.



Trigger if signal is:
Level(s)

The Level based triggering option also allows for two more types of triggering to be used:

- **Pre-Triggering**
- **Post-Triggering**

- 4 **Pre-Trigger** - record data for a specified time before a level trigger occurs (level trigger must also be selected).

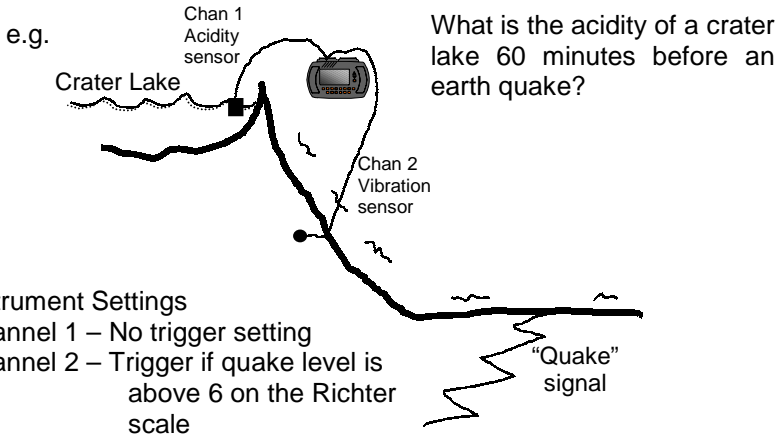

Pre-Trigger set to 60 minutes
Sample period = 1 second
Record for 2 hours

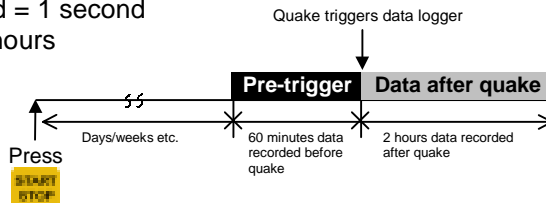

Once Pre-trigger is set, the data logger can be left for days, weeks etc. When the specified trigger level occurs, pre-trigger data is already saved in memory.

- 5 **Post Trigger** - start recording data to memory after a specified time has elapsed once a level trigger has occurred.

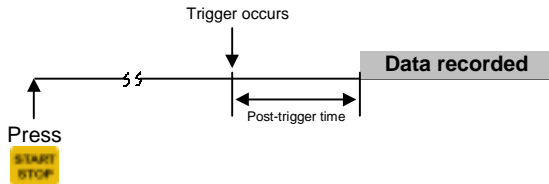

- 6 **Enable Channels** - select the channels you would like to record.

- Note:**
- Faster sampling rates are available if fewer channels are selected.
 - Less memory is used for recordings if fewer channels are enabled.

- 7 **Sampling Period** - the amount of time between samples.

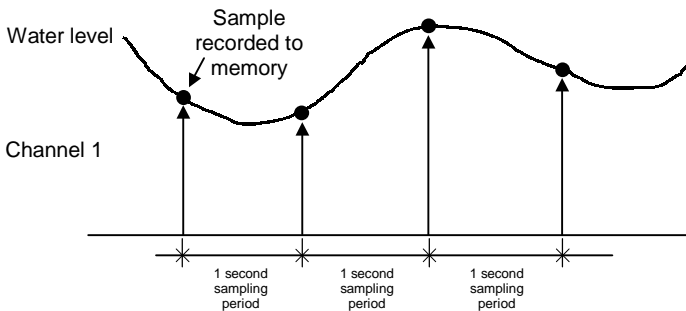





- Note:** There is a fraction of a second delay between channel 1, 2, 3 etc. recordings.

7 **Record For...** - the amount of time to record for, or the number of samples to take before recording automatically stops.

Note: If “*Auto Repeat Recordings*” (under the file menu) is selected and level trigger is also selected, a new file will be created as soon as the recording time has finished. This way you can get a separate file every time a lake level goes into flood for example.

2.3.2 Setting Display Options

To specify how measured data is to be displayed:















- Access the main menu (see section 2.1.2).
- To display measured data in the form of text, press *Display* ▶ *Text*. The real-time readings are displayed for each enabled channel.
- To display measured data in text with a bar that indicates the amount of current being measured at the current point in time, press *Display* ▶ *Bar*.
- To edit the measurement unit for a channel, press *Display* ▶ *Edit Channel Units...* In the *Enter Channel Unit* window, select the channel by pressing  or  and then edit the name of the unit (see section 2.1.5).
- To edit the name of a channel, press *Display* ▶ *Edit Channel Names...* In the *Enter Channel Name* window, select the channel by pressing  or , and then edit the name of the channel (see section 2.1.5).

2.3.3 Graph Controls

To view an xy-graph:

- Press *Display* ▶ *Graph*.

The following controls are available when viewing a graph. When a file is being played back, additional cursor and zoom controls are available.

Option	Meaning
	Active cursor moves right (Playback only)*
	Active cursor moves left (Playback only)*
	Toggle active cursor (Playback only)*
	Zoom In and Out between cursors (Playback only)*
KEYS 1 – 8	Select channel 1 to 8
  (quick key press)	Increase y-axis scale range
  (quick key press)	Decrease y-axis scale range
  (continuous key press)	Scroll graph up
  (continuous key press)	Scroll graph down
 	Resets graph settings to default

(Playback only)* - Cursors are available only when playing back a file. For more information on *Playback* mode please see sections 2.5 and 2.6.

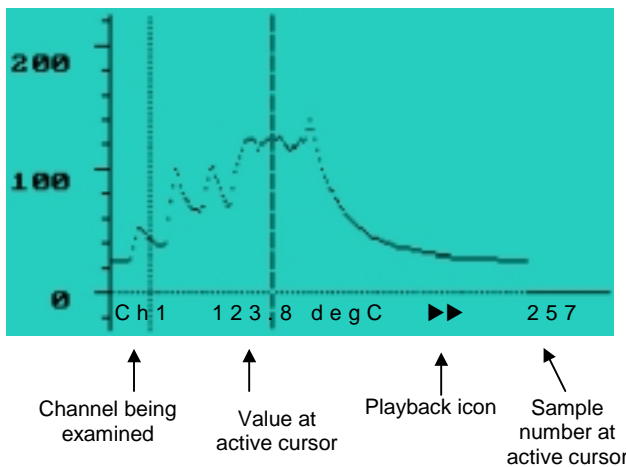

Note: To leave the “Playback” environment either press



or select *Display* ▶ *Exit Playback*.

2.4 RECORDING DATA

2.4.1 Setting Up the File name

The data recorded in a single recording session is stored as a file. The name of the file into which data will be recorded is displayed at the bottom of the data-display screen.

- To edit the name of the file, press *File* ▶ *New Recording*. In the *New Recording Setup* window, select *Filename* and edit the filename in the *New File Name* window (see section 2.1.5).
- File names are automatically numbered after the first recording e.g. Lake level, Lake level 1, Lake level 2... etc.

2.4.2 Choosing a Folder

For identification purposes, it is convenient to group files that are related under a common folder.

- To choose the folder under which the recording file is to be grouped, press *File* ▶ *New Recording*. In the *New Recording Setup* window, select *Folder*, and in the *Save Recording in Folder...* window, select the folder.
- If a new folder is required, press *Folder* in the *Save Recording in Folder...* window, select the new folder, and then press *Rename* to edit its name. Then select the newly created folder in order to place the recording file in it.

2.4.3 Starting a Recording

- From the main display screen press  to start the recording.

Data will be recorded and displayed according to how the input, trigger, and display options were set up. The sample number is updated on the bottom right of the screen as the samples are collected.

The data is recorded into the file and folder you chose earlier (the name of the file is displayed at the bottom of the screen).

2.4.4 Auto-Repeating Recordings

If recordings are level-triggered, the instrument can be instructed to take recordings repeatedly. This is useful for capturing the next level trigger event.

To auto-repeat level-triggered recordings:

- Press *File* ▶ *Auto Repeat Recordings* to check (✓) the option.
- To stop a recording press the  key.

2.4.5 Chained Recordings

The instrument has a maximum capability of approx 60,000 data points per individual recording. When this size is reached, another file is created and recording continues without intervention or loss of data.

Note: Each sample of each channel uses up a data point, e.g. a 4 channel recording of length 10,000 samples uses up 40,000 data points.

Chained recordings are denoted with an x/y extension. Which can be interpreted as the xth number part of a total of y parts.

e.g. Untitled 1/2
 Untitled 2/2

When transferring to MAS, if the entire folder is selected and sent, then the chained recordings will be recombined into a single long recording.

2.5 PLAYING BACK

To play back a recording:

- Press *File* ▶ *Examine files...*



- In the *Playback File* window, select the recording to be played back and press **ENTER**.



Note: Recordings can be played back in either the text, bar or graph display modes, independent of the mode that they were recorded in.

- In the data-display screen, press **▲** to move forward through the samples and **▼** to move backwards. Press **START/STOP** to return to the beginning of the recording (the sample number is displayed at the bottom right of the screen). The instrument beeps when you have reached the first and last samples.
- The display type and units can be altered in the playback, any changes made during playback are only for the duration of the playback. This allows recordings to be viewed in an alternative view from the way that they were recorded.
- To exit Playback mode either press **SHIFT** **BACK** or *Display* ▶ *Exit Playback*.

Note: In the *Playback File* window, there are also options to rename or erase a folder or recording, create a new folder and collapse or expand the data tree.

2.6 FILE UTILITIES

In the file selection window (*File ▶ Examine Files*) the following utilities are available:

Option	Meaning
1. <i>Shrink / Expand</i>	Shrinks or Expands the File Folder structure to make selecting a folder easier and quicker.
2. <i>Folder</i>	Creates a NEW FOLDER.
3. <i>Rename</i>	Renames a file or a folder.
4. <i>Copy</i>	Copies the selected file's setup (channel names, units, trigger type etc.) so that the next recording's setup is the same.
5. <i>Lock</i>	Prevents a file from being erased with the "ERASE" option. This option can be used to lock your recordings so their setups are protected and can then be copied at a later date. WARNING: <i>File ▶ Erase All Memory</i> will erase a locked file.
6. <i>Erase</i>	Erases the selected file or folder (does not erase locked files/folders).
7. <i>Snd to PC</i>	Sends the selected file or folder to the PC (see section 4).
 or 	Selects a file for playback or selects the active FOLDER to record into (if Window Title is "Save Recordings in Folder...").

2.7 OUTPUTTING SAMPLES FROM RS232

Press *File* ▶ *Output Samples to RS232* to send real time data in ASCII format from the instrument's RS232 port.

This data can be captured by a PC (e.g. using HyperTerminal).

Channel Number	Values	
1	4.5000	} Approximately 200ms between channel readings
2	6.8251	
3	100.02	
4	99.800	
1	4.6000	} Cycle continuously repeats
2	6.8252	
3	100.00	
4	200.00	

Format of Data

<channel number><space><channel value><CR><LF>

(8 data bits, no parity bit, 1 stop bit)

The default bit rate is 9600 bits/second, but it is possible to have the instrument send data at 57600 or 19200 bits/second.

To select a higher rate, send the instrument approximately 20 'Q' characters (e.g. press Q in HyperTerminal 20 times) at the bit rate you desire.

- Note:**
- '*' characters will be echoed while the 'Q' characters are being transmitted.
 - Operating the instrument's menus may temporary disrupt the transmission of samples from the RS232 port.
 - Transferring files to MAS cancels RS232 sample transmission.
 - When using Timer Trigger, COMs will default to 9600 bits/second after the first wakeup.



UTILITIES



This section outlines the procedure for performing utility functions on your instrument . You will learn to:

- reset the instrument ;
- adjust the instrument LCD;
- set the instrument clock;
- manage the instrument battery pack;
- manage memory usage on the instrument ; and
- troubleshoot the instrument .

WARNING: Read section 1.4 before operating your instrument .

3.1 RESETTING THE INSTRUMENT





Sometimes, due to electrostatic discharge exceeding 8kV, the instrument may not respond to any key presses (including  presses). In such cases, it is important to reset the instrument as soon as possible. To reset the instrument :

- Press  while holding down  and then release them both simultaneously, once the initialization screen has been displayed.

Once reset, the instrument displays the *Initialization* screen and resumes normal operation. Resetting the instrument does not erase data or settings stored in the instrument .



3.2 ADJUSTING LCD

3.2.1 Adjusting Contrast

- Press *Sys* ▶ *LCD-Contrast...*
- To darken the LCD, press . To lighten it, press .
- To restore the default contrast, press  then .

If the screen flickers when cursors are moved, make the LCD darker.

3.2.2 Turning Backlight On

To toggle the backlight ON and OFF press  then .





3.3 SETTING CLOCK

3.3.1 Checking Date and Time

- Press *Sys* ▶ *Clock*.

All recordings are date and time stamped according to the clock shown in the *Date & Time* window.

3.3.2 Setting Date and Time

- Press *Sys* ▶ *Clock*.
- To cycle to a particular field, press .
- To edit the value of a field, press  and .
- Press  when you have finished.

If the *am/pm* hour format is chosen, the hour switches back to 1 at the thirteenth hour. If the *24h* format is chosen, the hour continues incrementing until 23 before switching back to 0.

3.4 MANAGING BATTERY

3.4.1 Instrument Battery

The instrument is powered by a rechargeable Nickel-Cadmium (Ni-Cad) battery pack. The normal operating voltage is 6.0 to 8.5 Volts.

Some automatic features have been built into the instrument to help ensure that the battery pack is always sufficiently charged. Below 6.6 Volts, the instrument displays a flashing  icon at the bottom right corner of the screen and beeps once every minute as a reminder that the battery pack needs to be charged. Below 6.1 Volts, the instrument automatically turns off the backlight to prevent further power draining. Below 80% battery capacity, the instrument automatically begins to charge the battery pack (if external power is supplied). At 5.5 Volts, the instrument automatically powers down. The power saver is another feature that helps conserve power on the instrument – see section 3.4.6.

There is also an internal backup battery that backs up data and settings in the instrument in the event that the battery pack is detached from the instrument . The backup battery is kept charged by the battery pack if the battery pack is functioning normally.

WARNING: Do not detach the battery pack from the instrument for more than 2 hours as this will drain the backup battery, thereby causing data and settings to be lost.

The battery pack can be charged by supplying $13.5 \pm 1.5\text{VDC}$, 1A power to the instrument charger socket. The power transformer supplied in the kit provides this DC voltage. The optional car adapter charging lead may also be used to charge the battery pack in a vehicle with a 12-Volt negative-chassis power system.

WARNING: Before charging the battery pack, ensure that the power transformer used is an approved instrument power transformer ($13.5 \pm 1.5\text{VDC}$, 1A output) and that the voltage and frequency of your mains AC power match that of the power transformer.

3.4.2 Checking Battery Capacity

- Press *Sys*

The remaining battery capacity and voltage are displayed.

3.4.3 Charging Powered-up instrument

WARNING: See the warnings in section 3.4.1.

- Plug the instrument power transformer into a standard power outlet and its connector to the instrument charger socket. If the battery capacity is less than 80%, charging begins automatically.
- If charging does not begin automatically, press *Sys* ▶ *Charge Batt* Charging, as indicated by the  icon in the dropdown menu, begins.

If the  icon is not displayed, check that the mains power is turned on. Charging stops automatically when complete or you can press *Sys* ▶ *Charge Batt* to stop it. A full charging cycle takes approximately 150 minutes. All other functions are usable while the battery pack is being charged.

3.4.4 Charging Powered-down instrument

WARNING: See the warnings in section 3.4.1.

- Plug the instrument power transformer into a standard power outlet and its connector to the instrument charger socket. The instrument powers up and charging, as indicated by the flashing “CHARGING” message beside the *Charge Batt* option in the *Sys* dropdown menu.

If the instrument does not power up, reset the instrument (see section 3.1), or unplug the power transformer connector and re-plug it in. See also section 3.4.3 notes.

3.4.5 Reconditioning Battery Pack

WARNING: See the warnings in section 3.4.1.

Battery reconditioning is the process of first discharging and then charging batteries. It reduces the undesirable memory effect in Ni-Cad batteries. The battery pack should be reconditioned when it is first used (for its capacity to be displayed correctly) and monthly thereafter (to prevent battery degradation). To recondition the battery pack:

- Plug the instrument power transformer into a standard power outlet and its connector to the instrument charger socket.
- Press Sys ▶ *Recondition Batt.*

After discharging the battery pack, the instrument automatically proceeds to charge it. See also section 3.4.3 notes.

3.4.6 Power Saver

Every time the instrument is powered up, the power saver – a power-saving feature – is automatically turned on. With the power saver turned on, the following occurs automatically if no keys are pressed for a period of time and no recording is taking place after 8 minutes, the LCD is turned off (but any key press will turn it on again) and after 15 minutes, the instrument is powered down. To turn the power saver on or off:

- Press Sys ▶ *Power Saver.*

3.4.7 Replacing Battery Pack

- Lift the boot stand.
- Unscrew the battery pack and screw in the new one using a suitable screwdriver or coin.

WARNING: Ensure that the battery pack is securely fastened – but not over-tightened – to the instrument .

3.5 ERASING MEMORY

WARNING: Following the procedure below erases **ALL** folders and **ALL** recordings in the instrument .

Before erasing data, you may wish to archive it on your PC (see section 4.3). To erase all folders and recordings:

- Press *File* ▶ *Erase ALL Memory...*
- In the *Erase All !* window, press  together and wait for the data to be erased.

To erase only one particular recording or folder, see section 2.5.

WARNING: Erase All Memory will reset the instrument to factory default settings. All locked folders and files will be erased.

3.6 TROUBLESHOOTING

3.6.1 Power Problems

Symptom	Cause	Remedy
Instrument cannot power up	Low battery capacity Electrostatic discharge (ESD) exceeding 8kV	Charge battery pack Reset instrument
Instrument powers down when backlight turned on	Low battery capacity	Charge battery pack
Instrument powers down shortly after powering up	Low battery capacity	Charge battery pack
Flashing  icon and beeping every minute	Low battery capacity	Charge battery pack

3.6.2 Data Problems

Symptom	Cause	Remedy
Data lost when battery pack detached for more than 2 hours	Flat backup battery	Charge battery pack
Data lost when battery pack detached for less than 2 hours	Faulty backup battery	Send instrument to authorized dealer for servicing
“Insufficient memory” displayed	No memory space left for recordings	Erase obsolete recordings (transfer to PC first if necessary)
Measured data seems incorrect	Sensor wired wrongly	Wire as recommended
	Faulty sensor	Replace sensor

3.6.3 Data-Transfer Problems

Symptom	Cause	Remedy
"No PC ?" displayed, and data cannot be transferred to PC	Data-transfer cable not properly connected	Re-secure cable connections
	Data-transfer cable connected to wrong PC COM port	Test COM port availability and use available port
	Baud rate setting in MAS-3000 too high	Select a lower baud rate in MAS-3000
MAS-3000 unable to transfer data and "Transfer failed" or "MAS Error Dialog" displayed on PC	Baud rate setting in MAS-3000 too high	Select a lower baud rate in MAS-3000

3.6.4 Other Problems

Symptom	Cause	Remedy
Instrument does not respond to any key press	Electrostatic discharge exceeding 8kV	Reset instrument
"Module fault" displayed	Module [†] damaged	Send instrument to authorized dealer for servicing
"Switch off then connect module" displayed	Module not properly plugged into instrument	Power down instrument then re-secure module, making sure not to bend the connection pins

[†] The "module" is the measurement hardware unit of the instrument . It has the four or eight current measurement channels attached to it and is fastened to the rest of the instrument by means of two M3x0.5x12mm screws.



ANALYSIS SOFTWARE

Recordings made on your instrument can be transferred to the MAS software running on a Windows® based PC. MAS stands for **M**easurement **A**nalysis **S**oftware. MAS can be used to store, graph, analyse, print & export your recordings.

It is assumed that the user of MAS is already familiar with basic Windows® commands. Please refer to the appropriate literature on Windows® if clarification is needed on mouse and keyboard commands.

Note Throughout MAS, pressing F1 on your keyboard will bring up a comprehensive topic-specific *Help* screen. Also, clicking the right mouse button anywhere in MAS will bring up a pop-up menu of the applicable commands.

WARNING: Read section 1.4 before operating your instrument .

4.1 INSTALLING MAS-3000

4.1.1 License Agreement

Please read the license and warranty agreement printed on the CD cover found in the jewel case that the MAS CD-Rom was supplied in. MAS is licensed for individual use and for installation on one computer. The software contained on the CD-Rom remains the intellectual property of COMMTEST INSTRUMENTS who retain the title and ownership of the software.

4.1.2 PC System Requirements

The following are the minimum system requirements for installing MAS:

- Pentium processor or better
- 32MB RAM (64MB recommended)
- 10MB hard disk space
- CD-Rom drive
- Windows® 95, 98, Me, NT or 2000 operating system
- Windows® compatible display and printer
- Windows® compatible mouse or other pointing device
- An unused COM Port for communication with the instrument

4.1.3 Installing MAS on PC

- Close all programs on your PC.
- Insert the MAS CD-Rom into the CD-Rom drive.
- Wait for the MAS Installation program to automatically start (or run Setup.exe located on the CD-Rom).
OR
Run the MAS Setup.exe program located on the CD-Rom.
- Follow the instructions given to complete the installation.

4.2 STARTING UP MAS

4.2.1 Starting up

- Click *Start* ▶ *Programs* ▶ *MAS-3000* ▶ *MAS-3000 5.00*

4.2.2 Configuring PC COM port

- To allow data transfer between the instrument and the PC, you must first configure your PC COM port as follows:
- Connect the instrument to one of the COM ports using the data-transfer cable and power up the instrument .
- Click *Tools* menu ▶ *Configure COM port*.
- Select the COM port that the instrument is connected to.
- Select a baud rate. The baud rate is the speed (in bits/second) at which data is transferred. The lower the baud rate, the less likely are data-transfer errors. *Automatic* is the default choice as it is sufficient for normal transfers.
- Click *Test port*
- Click *Yes* in the *Confirm* window to test the connection. Connection failure may be due to the selection of the wrong COM port in MAS, the instrument being not powered up, connectors being not plugged in properly, or the PC serial port being not set up properly. If the connection is good, continue as follows:
- Click *OK* in the second confirm window to acknowledge that the instrument is attached to the COM port.
- Click *OK* to leave the *MAS Configuration* window.

4.3 TRANSFERRING DATA TO THE PC

Data transferred to the PC is stored in MAS *files*. These are text files and have the .mas extension.

To transfer data from the instrument to the PC:

- Turn on the instrument Check its battery capacity and if less than 30%, charge the battery pack.
- Connect the RS232 port of the instrument to the configured PC COM port using the data-transfer cable. On the PC click the *Receive* button.
- On the instrument , press *File* menu ▶ *Examine Files...* Use the arrow keys to select the individual recording or folder to be transferred. If a folder is highlighted, all recordings within the folder will be transferred.
- Press  *SndToPC* to send the selected recording or folder. Once the data-transfer is complete, the data will appear in the current file in MAS or if no files were open, the data will appear in a new file.
- To append more data from the instrument to the current file, click the *Receive* button.
- Alternatively, to receive more data but in its own new file, click *File* menu ▶ *Receive from MMS* ▶ *Transfer to a New File*.
- To save the data in the current file, click the *Save* button, name the file and click *Save*. If the file was an already existing file, clicking the *Save* button will automatically save the file under the same name and in the same location on the PC.

4.4 MANAGING DATA

4.4.1 Opening a File

- Click *Open* button and select the file.

4.4.2 Merging Two Files

- Open one of the files.
- Click *File* menu ▶ *Import & Merge a file...* and select the other file to be merged into the open file.

The merged data can be viewed but is not automatically saved on the computer. To save it, click *File* menu ▶ *Save* or *Save As*.

4.4.3 Using the Navigator

When a file is open, the navigator that consists of two boxes is displayed on the left side of the screen. The top box shows all the folders in the file. The bottom box shows all the recordings in the selected (highlighted) folder in the top box.

4.4.4 Deleting Data from a Folder

- Select the folder in the *Folder* section of the navigator.
- Using the navigator, select the individual recordings and/or channels to be deleted.
- Click *File* ▶ *Delete*, or press the *Delete* key. You will then be prompted to confirm that you wish to delete the selected recordings/channels

4.4.5 Editing Recording Details

- Select the folder, and then the recordings and/or channels to be edited.
- Click the *Info* tab to access the *Info page* where you can edit the *User Details* (eg. Company Name, instrument serial number...), *Folder Name*, and the *Recording Details* (eg. recording name, remarks, channel labels and units...).
- From the *Edit User Details* screen there is access to edit the *Default User Details*. These values are written to all future recordings, while they are being transferred from the instrument .

4.4.6 Viewing and Printing Data

- Open the file and using the navigator, select the recordings and/or channels to be viewed and/or printed.
- Click the *Values* tab. The data in the selected recordings and/or channels can now be viewed.
- To change the value in a cell, click the cell and type in the new value.
- To reduce the amount of data by averaging, click the *Average* button.
- To print the data, click the *Print* button.
- To copy the values to a spreadsheet program, click the *Copy* (to clipboard) button, go to the Spreadsheet program and use its "*Paste*" command.
- To print a report on the data, click *File* ▶ *Summary Report*[‡] or *Full Report*[§] and select the print option in the *Data Summary* or *Report Generator* window that appears.

‡ The Summary report produces a data summary about the selected recordings/channels. For more information consult the MAS help file.

4.4.7 Exporting data

- In the Navigator select the folders or recordings to be exported as a .mas file.
- Click *File* ▶ *Export* and select the option required.
- Provide the name and location of the export file to be produced and then click the *Save* button.

§ The Full report produces a printout of the pages selected in the report generator window. For more information consult the MAS help file.

4.5 CALCULATING DATA

You can perform calculations on your recorded data by creating new "calculated" channels:

- Open the file and using the navigator, select the recordings and/or channels to be used in calculations.
- Click the *Values* tab to display the data and click the *Calculate* button to access the *Calculate* window.
- Each channel is automatically given a "**tag**" character that is used to identify the channel. It is a letter of the alphabet that can be used to reference the values of a recording for use in calculations.
- Expressions can then be derived using the provided functions and the channel tags**.

eg. $\text{TempChange} = \text{ChangePerHr}(B)$ with units degC/hr

This example will create a channel called "*TempChange*" which is calculated as the rate of change per hour of the channel which has tag '*B*'.

- Constants can also be used in calculations. You may need to use constants in your expressions, for example:

To find the "difference from the mean value" for a particular channel, say the channel represented by "**tag**" '*D*'.

A constant should be defined to provide the mean value of channel '*D*', " $K0 = \text{Mean}(D)$ "

This constant is then used in the expression,
" $\text{DiffFromMean} = D - K0$ "

** See Appendix MAS-3000 MATH for a complete list of functions available.

4.6 PLOTTING DATA

4.6.1 Plotting Single and Individual Charts

- Open the file and using the navigator, select the recordings and/or channels to be plotted.
- Select the *Chart* tab and click the *Plot* button. You can also plot a recording or channel by double-clicking it in the navigator.
- To display the selected recordings and/or channels on individual charts, click the *Individual* button.
- To change the format of charts, click the *Adjust* button to access the *Adjust Axes & Colors* window. This window allows for changes to be made to the axes and colors of the plotted recordings displayed on the chart.
- To clear all plotted recordings, click *Chart* menu ▶ *Clear Chart*. To retain existing plots when adding to the chart, click the *Hold* button. A maximum of 16 plots can be displayed at a time

To enlarge a chart, you can hide the legend by clicking *Chart* menu ▶ *Show Legend*. You can also Hide the navigator by clicking *Window* menu ▶ *Show Navigator*.

4.6.2 Zooming & Panning

To zoom in on any part of a chart:

- Click a point to the left of that part of the chart and drag a rectangle across and down to the right over the section to be enlarged (while holding down the left mouse button). Release the mouse button to perform the zoom.

To zoom in horizontally:

- Proceed as above, but only move the mouse directly up or down to select the area to be enlarged. Two horizontal lines will be displayed across the chart to indicate the selection.

To zoom in vertically:

- Proceed as above, but only move the mouse directly left or right to select the area to be enlarged. Two vertical lines will be displayed across the chart to indicate the selection.

To unzoom from any view:

- Left click on any point in the chart and drag a rectangle up and to the left to display a rectangle with a cross in it. When the mouse button is released all zooming will be undone and the chart will be returned to its original view.

Panning

- The chart displayed can be dragged in any direction to display sections that are hidden from the current view. To pan around the chart click and hold down the right mouse button in the chart display. The cursor will turn into a pointing hand icon. Drag the mouse pointer in the direction that you wish to move the chart.

Note: If you move the cursor off the chart, you will have to release the right mouse button and return it to within the chart boundaries to continue panning.

4.6.3 Printing Charts

- Click *Print* while the chart is displayed.

4.6.4 Reading and Comparing Values

To place cursors on charts to read the data values on curves:

- Plot the recordings and/or channels on a single chart.
- To place a cursor at a particular point on a curve, place the mouse cursor at that point, follow the curve until a crosshair appears, and then click the left mouse button. If the default cursor options are used, the cursor comprises a horizontal and a vertical dashed line, and the values indicated by the cursor are displayed at the edge of the chart next to the dashed lines.
- To move the cursor to a different point on the same curve, press the horizontal arrow keys. To move in small steps, hold down the Ctrl key when pressing the horizontal arrow keys. You can also move the cursor by clicking the left mouse button on the new point (first allowing a crosshair to appear).
- To move the cursor to a different curve, push the vertical arrow keys. Alternatively, click the left mouse button on the new curve, or on the appropriate symbol on the legend.
- To place a second cursor on the chart, place the mouse cursor at the point of interest, follow the curve until a crosshair appears, and then click the right mouse button. If the default cursor options are used, the difference between the values indicated by the cursors is shown at the top right corner of the chart. Cursor A corresponds to left mouse button and cursor B to the right.
- To toggle the focus between the cursors, push the space bar, a cursor must be focused before it can be moved using the arrow keys. A cursor is focused if it has a rectangular target.
- To clear the cursors, push the Esc key.
- To change cursor options, click *Chart* menu ▶ *Cursor Options....*

EXAMPLE: a two-channelled temperature recording with both cursors displayed (using the default cursor options).

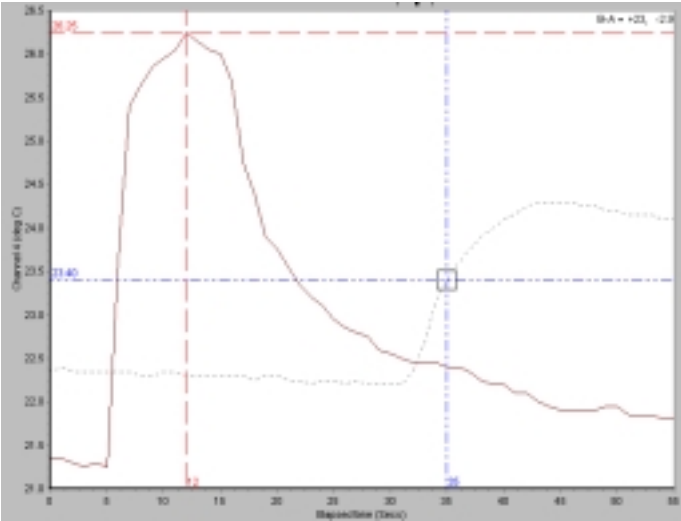

Each cursor displays the x and y axis values and the difference in both the x and y axis values of the two cursors in the top right hand side of the chart.

4.6.5 Plotting Waterfall Charts

- Plot the recordings and/or channels on a single chart.
- Click *Chart* menu ▶ *Waterfall Chart* and select the depth required.

Waterfall charts are useful for trending data behaviour. As on ordinary charts, cursor and zooming functions can be used on waterfall charts.

EXAMPLE: the four curves on the waterfall chart below correspond to three sets of data pertaining to the same measurement point. It can be seen that the peak value has a rising trend.

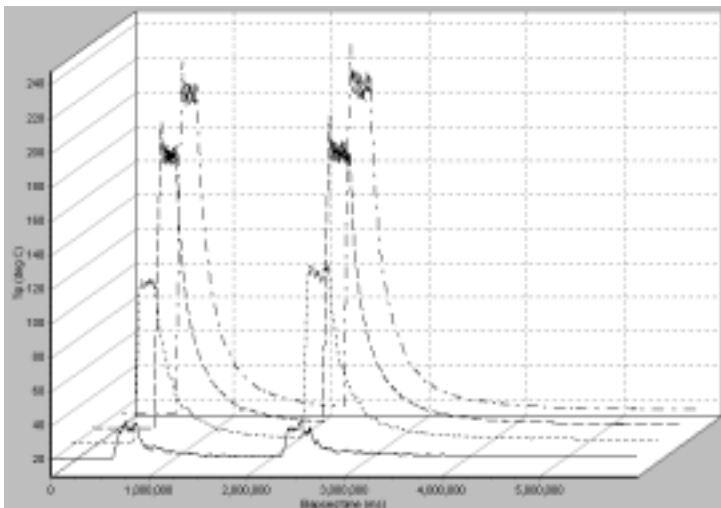

4.7 UPGRADING FIRMWARE

When an upgraded instrument firmware version is available, it will be posted on the COMMTEST INSTRUMENTS website. Once you have obtained the firmware file, the firmware can be upgraded using the PROFLASH procedure below.

WARNING: Upgrading the firmware erases all data in the instrument.

- Check the instrument battery capacity and if it is less than 30% charge the battery pack.
- Connect the RS232 port of the instrument to the configured PC COM port using the data-transfer cable.
- Power up the instrument and transfer any data you wish to keep to MAS on a PC.
- In MAS click *Tools* menu ▶ *PROFLASH MMS*. In the *PROFLASH* window click the *PROFLASH* button ▶ *Automatic search*.



- Click *Select Drive to Search* and select the drive where the new firmware version is located.

- Click *Start Search*, and when the search is completed select the new firmware file.
- Click *Start proflash using this file*.

Once the proflashing is complete, the instrument will beep and the Initialisation screen will appear. If an error occurs, check that the data-transfer cable has been connected properly and that the instrument is powered up.

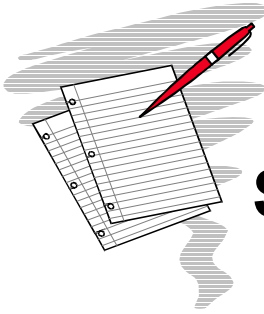

Appendix SPECIFICATIONS

The following are the specifications for:

- instrument firmware version 2.50
- MAS software version 5.00

These specifications may be changed in future versions.

Specifications	Models: MMS3000-GP4 and MMS3000-GP8 4 (MMS3000-GP4) and 8 (MMS3000-GP8) Current Loop Input Channels with General Purpose Conversion Software		Remarks
Current Range Nominal current range Maximum current range	4 to 20mA 3.2 to 24mA		4mA corresponds to 0 units (units selectable in software), 20mA corresponds to full-scale indication. Offset and span are user-adjustable.
Current Resolution	2µA (1 part in 2,000 @ 4mA, 1 part in 10,000 @ 20mA)		
Current Accuracy	± 0.1% of reading ± 5µA		Instrument offset and span calibrated to nominal values. Instrument temperature 73 ± 18°F (23 ± 10°C).
Engineering Units Units Scaling	Metric and imperial for temperature, displacement, force, pressure, voltage, current, etc., customizable units, and percentage pico, nano, micro, milli, kilo, mega, giga, tera		Standard and customizable engineering units and scaling are user-configurable.
Minimum Sampling Interval	Number of channels selected (user-selectable)	Minimum sampling time (seconds)	
		0.2 0.3 0.4 0.5 0.6 0.7 0.8 0.9	<u>Minimum</u> time to scan <u>all</u> selected channels, not each channel. Sampling interval is programmable from 0.2 seconds to 60 hours. Model MMS3000-GP4 has 4 channels only.
Data Logging Data Storage Format Data Storage Folder Name	Up to 50 named folders Multiple files per folders Up to 59,999 data points per file (files are automatically chained) 512 kilobytes – approximately 400,000 individual samples Up to 16 alphanumeric characters		User-specified name entered from keypad. Each file has unique time and date stamp. MAS plots limited to maximum of 15,000 samples per channel. Non-volatile memory (with battery backup). Number of samples depends on number of folders and files.
Display Resolution Viewing Area Backlight	LCD with graphic capabilities 240 x 128 pixels 4.3" x 2.3" (110mm x 60mm) Electro-luminescent		
PROFLASH	Allows internal firmware to be upgraded via built-in serial port		Download firmware upgrades via the internet.
Communications Baud Rate	RS232 9600, 19200, 57600 bits per second		15kV ESD protected. Cable with DB9 connector included. Automatic baud rate selection.
Input Termination	Screw terminals, 5mm pitch, 2.5mm ² wire size		4 pairs for model MMS3000-GP4, 8 pairs for MMS3000-GP8.
Loop Burden	Maximum 6 Volts at 20mA loop current		
Isolation	Optically isolated		Between each current loop input and between each current input and instrument outputs e.g. RS232 port. The instrument is not intended for connection to "live" surfaces (voltage exceeding 50 VDC or 32 VAC).
Battery Type Voltage Capacity Operating Time	Custom Nickel-Cadmium pack 7.2 Volts nominal 1500mAh nominal 13 hours nominal with backlight off, 7 hours nominal with backlight on		
Charger & Conditioner Fast Charge Rate Discharge Rate	Built-in dual rate charger – automatic and manual control 0.7A nominal 0.5A nominal		Power transformer (13.5 ± 1.5VDC, 1A output) included in kit. 2.5 hours for complete charge nominal. Combats Ni-Cad battery memory effect.
Mechanical Size Weight	9.7" W x 6.1" L x 3.0" H (247mm W x 154mm L x 75mm H) 4.4lb (2kg)		Including protective boot. Including protective boot and strap.
Environmental Temperature/Humidity Operating Storage EMC	32°F to 122°F (0°C to 50°C) / 80% RH 32°F to 86°F 70% RH 32°F to 122°F 14°F to 140°F (-10°C to 60°C) / 95% RH EN50081-1 EN50082-1		Non-condensing. Non-condensing. Radiated and conducted emissions. RF field, ESD and fast transient immunity.

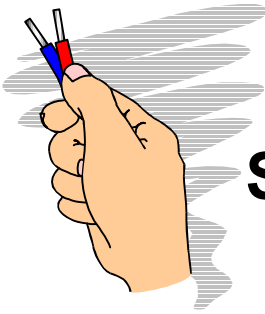

Appendix

SENSOR WIRING

Some common configurations are shown below for two and four wire sensors^{††}. The power supply for the sensors can either be taken from an external source (e.g. a battery or commercial power supply) or from the internal supply (12 or 24V). To enable the internal supply select *Sys ▶ Power to sensors* (this option will drain your battery faster even if no sensors are connected).

Note: The following diagram show wiring for 4 channels only. It is also possible to perform the similar wiring for the 8 channels of the GP8.

WARNING: To avoid electrical shock, do not connect any sensor to a high voltage i.e. a voltage that exceeds 50VDC or 32VAC or the “safety extra low voltage” (SELV) defined by your local power authority.

^{††} Also known as “transmitters”.

6.1 TWO-WIRE 4-20mA SENSORS

6.1.1 Two-Wire 4-20mA Sensors

Connecting Sensors using Internal Power Supply

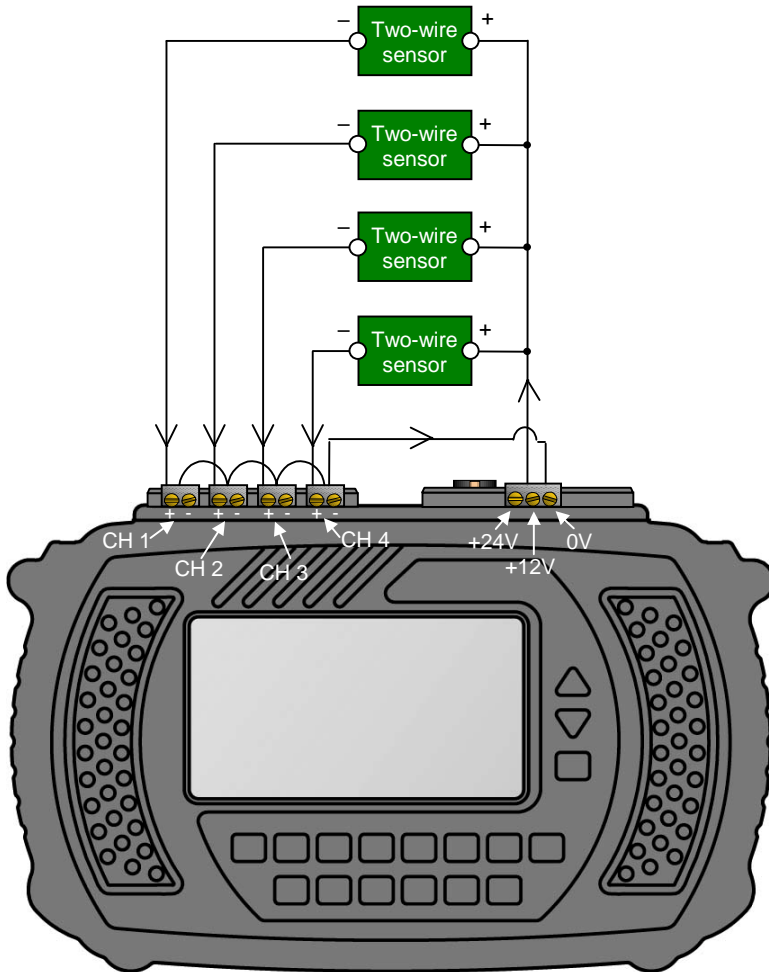

Note: 12V sensors shown above, 24V can be used also.

6.1.2 Connecting Sensors using External Power Supply

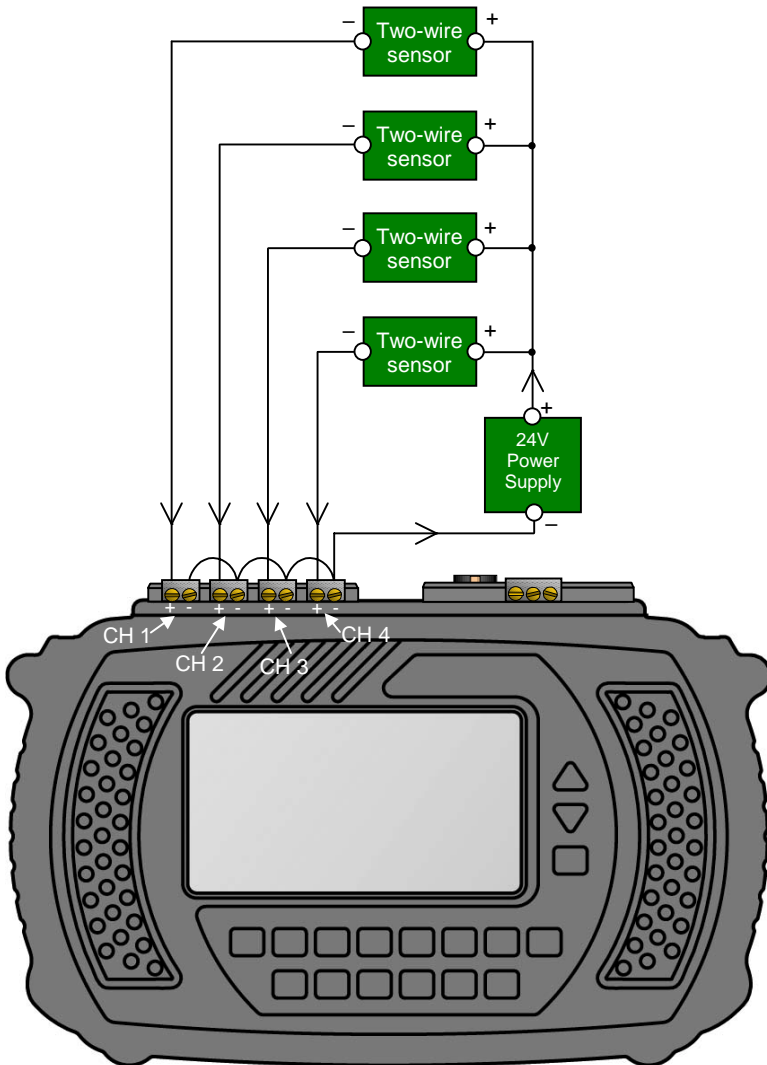

Note: 24V sensors shown above – other sensor types can be used also.

6.2 FOUR-WIRE 4-20mA SENSORS

6.2.1 Connecting Sensors using Internal Power Supply

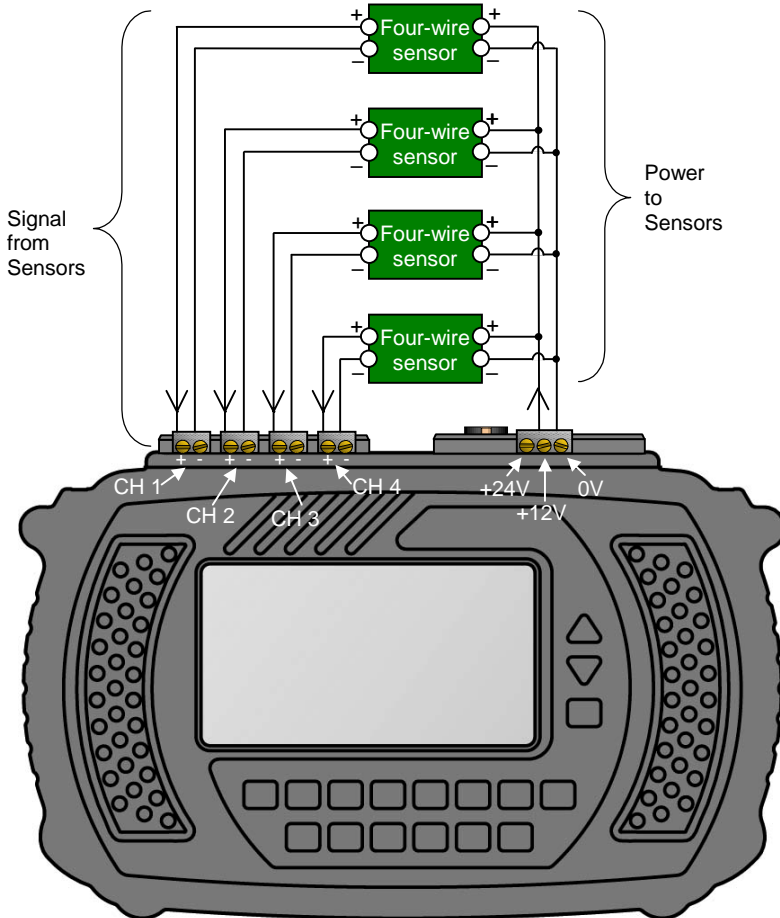

Note: 12V sensor shown above, 24V can be used also. Consult your Sensor's documentation for alternative wiring methods.

6.2.2 Connecting Sensors using External Power Supply

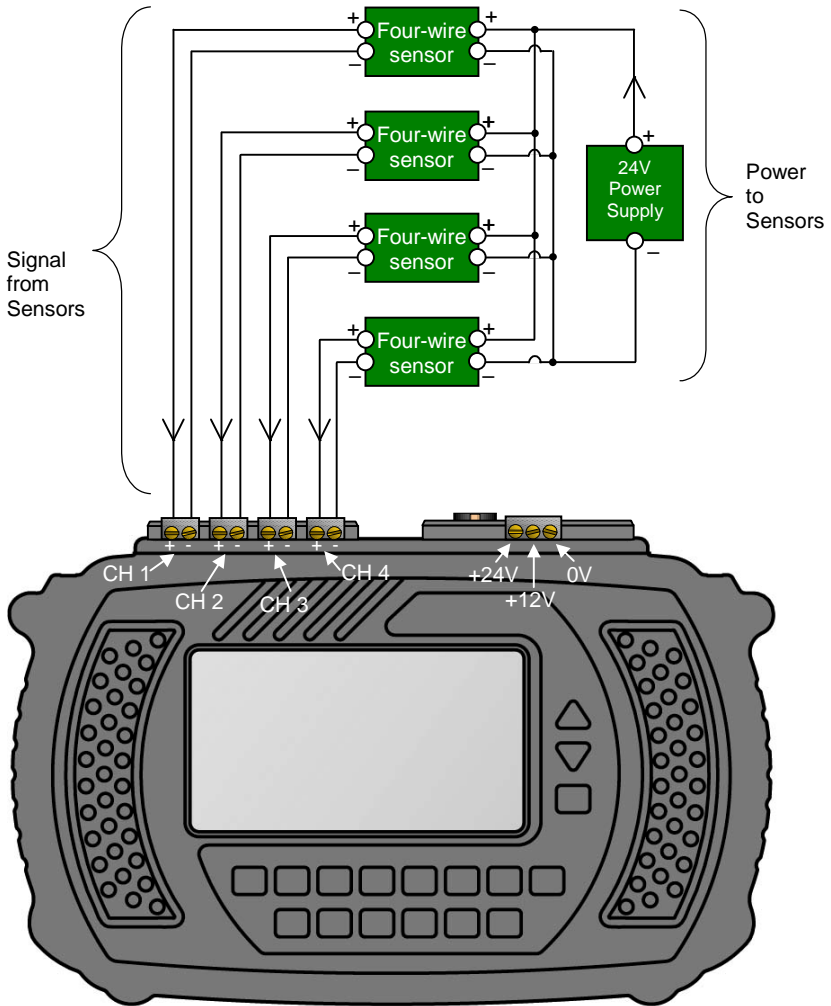

Note: 24V sensors shown above – other sensor types can be used also. Consult your Sensor’s documentation for alternative wiring methods.



Appendix

MAS-3000 MATH

The following are the mathematical functions and operators that can be used in MAS-3000 calculations.

The symbols A,B,C,... represent channel tags; and L1, L2, ..., Ln represent logical expressions (e.g. $\text{int}(A) > 3$).

The notation used for functions and operators is similar to that used in common computer-programming languages and spreadsheet programs.

7.1 FUNCTIONS

7.1.1 Mathematical Functions

Function	Meaning
Abs(A)	Absolute value
Cos(A)	Cosine
Deg(A)	Convert from radians to degrees
DegC_to_DegF(A)	Converts Celsius to Fahrenheit
DegF_to_DegC(A)	Converts Fahrenheit to Celsius
Exp1	Base of natural logarithm, e (constant)
Exp(A)	Exponent
Frac(A)	Fractional part
Int(A)	Integer part
Ln(A)	Natural logarithm
Log(A)	Base 10 logarithm
Max(A, B, ...)	Return the maximum value
Min(A, B, ...)	Return the minimum value
N	Sample number (starting from zero)
Pi	π (constant)
Power(<i>base, power</i>)	<i>base</i> to the power of <i>power</i> e.g. Pow(A,3) gives A^3 Pow(3,k1) Pow(A,B)
Rad(A)	Convert from degrees to radians
Round(A)	Rounded value
Sgn(A)	Sign (-1 if negative; +1 if positive; 0 if zero)
Sin(A)	Sine

Function	Meaning
Sqr(A)	Square
Sqrt(A)	Square root
Tan(A)	Tangent
ChangePerDay(A)	Rate of change (differentiation)
ChangePerHrs(A)	e.g. If channel 'A' changes smoothly from 10 to 25 over a 1 minute period, then ChangePerMin(A) will be 15 over that period.
ChangePerMin	
ChangePerSec	
SumOverDays	Summation over time (integration)
SumOverHrs	e.g. If channel 'A' is a 2hr recording with all values = 3.5, then SumOverHrs(A) changes smoothly from 0 to 7 over the recording.
SumOverMins	
SumOverSecs	

7.1.2 Iterative Functions

The following iterative functions can be used for constants only. Cell level expressions cannot contain iterative functions.

Function	Meaning
Count(A)	Number of samples
Maxsample(A)	Maximum sample value
Mean(A)	Mean
Minsample(A)	Minimum sample value
Stddev(A)	Standard deviation
Sum(A)	Sum

7.1.3 Logical Functions

Function	Meaning
AND(L1, L2, ..., Ln)	Logical AND e.g. AND(n = 10, k2 > 0.5, k3 > 0.5, k2 <> k3)
False	Logical constant, has value 0
OR(L1, L2, ..., Ln)	Logical OR e.g. OR(k0 = True, k1 < 3, n >= 30)
True	Logical constant, has value 1
AOR(L1, L2, ..., Ln)	Logical AOR (exclusive OR) e.g. AOR(k0 = True, k1 < 3, n >= 30)
NOT(L1, L2, ..., Ln)	Logical NOT e.g. NOT(k1 = True, k2 < 10, n > 30)

7.1.4 Conditional Functions

Function	Meaning
IF(L1, <i>true result</i> , <i>false result</i>)	<p>If logical expression L1 is true, execute <i>true result</i>, otherwise execute <i>false result</i> e.g.</p> <p>IF(k2 > k3, k2*A, k3*A)</p> <p>IF(k0 = True, n, n*2)</p> <p>IF(n < 10, n, Log(n))</p>

7.1.5 Date and Time Functions

In MAS-3000, the date and time value of when a sample is taken is a floating-point number. The integer part of the number represents the date: it is the number of days since the first day of 1 AD. The fractional part of the number represents the time: it is the proportion of time that has passed since the beginning of the day.

Function	Meaning
Date(<i>year, month, day</i>)	<p>Return the date in MAS-3000 format e.g.</p> <p>Date(1999, 07, 25)</p>
Time(<i>hour, minute, second, ms</i>)	<p>Return the time in MAS-3000 format e.g.</p> <p>Time(16, 59, 31, 965)</p>
Elapsed(<i>sample number</i>)	<p>Return the date and time of the sample in MAS-3000 format e.g.</p> <p>DAT(36)</p>
SampleDate(n)	Date of the nth sample
SampleTime(n)	Time of the nth sample

7.2 OPERATORS

7.2.1 Logical Operators

Operator	Meaning
<	Less than
<=	Less than or equal to
<>	Not equal to
=	Equal to
>=	Greater than or equal to
>	Greater than

7.2.2 Arithmetic Operators

Operator	Meaning
+	Addition
-	Subtraction
/	Division
*	Multiplication

The order of precedence is as in standard arithmetic (i.e. /, *, +, -). An operand between two operators of different precedence is bound to the operator with higher precedence. An operand between two equal operators is bound to the one on its left. Expressions within parentheses are evaluated before being treated as a single operand.