



**$\frac{1}{8}$ -DIN
DUAL COLOUR DISPLAY
TEMPERATURE INDICATOR**

Product Manual

59135-2

HOW TO USE THIS MANUAL

This manual comprises two volumes:

VOLUME I OPERATING INSTRUCTIONS

- | | |
|------------------|---|
| SECTION 1 | Front panel controls and indicators
Process Variable (current, max. and min. values)
Accumulated alarm elapsed time
Alarm values
Resetting a latched alarm
Alarm Hysteresis |
| SECTION 2 | Linear (Re-Transmission) Output scaling
Process Variable Offset
Input filtering
Serial Communications address and Baud rate
Display colour settings
Protection of alarm levels
Help level |
| SECTION 3 | Setting up and using the communications link between the Indicator and your computer |

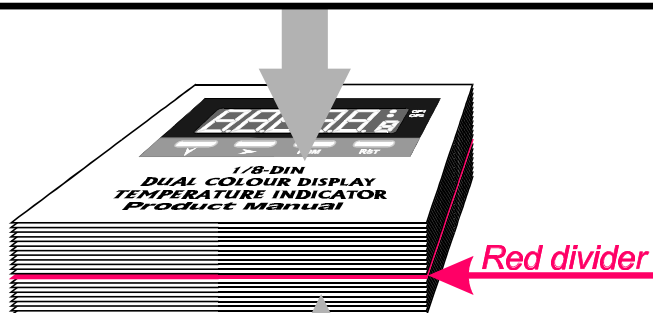

VOLUME II INSTALLATION & CONFIGURATION INSTRUCTIONS

- | | |
|-------------------|---|
| SECTION 1 | Panel-mounting and wiring-up the Indicator |
| SECTION 2 | Fitting/removing options; selecting the required linear output range. |
| SECTION 3 | Matching software to hardware fitted
Selecting input type and range, alarm type(s) and output usage
Selecting option fitted |
| SECTION 4 | Changing the configuration of your Indicator via the communications link. |
| APPENDIX A | Product Specification |



The functions described in Volume II must be performed only by personnel who are trained, equipped and authorised to do so.

$\frac{1}{8}$ -DIN DUAL COLOUR DISPLAY TEMPERATURE INDICATOR

Product Manual

Contents - Volume I

1	OPERATION MODE	1-1
1.1	FRONT PANEL	1-1
1.2	PARAMETER SEQUENCE	1-2
1.3	INPUT OVER-RANGE OR UNDER-RANGE	1-3
1.4	SENSOR BREAK	1-3
1.5	CHANGING AN ALARM VALUE	1-3
1.6	RESETTING A LATCHED ALARM	1-4
1.7	ALARM HYSTERESIS	1-4
1.8	SUMMARY OF PARAMETER IDENTIFIERS (SECONDARY DISPLAY)	1-4
2	PROGRAM MODE	2-1
2.1	ENTRY/EXIT	2-1
2.2	PARAMETER SELECTION	2-1
2.3	EDITING THE DISPLAYED PARAMETER (EDIT MODE)	2-2
2.4	PARAMETER SEQUENCE	2-3
3	SERIAL COMMUNICATIONS	3-1
3.1	DATA FORMAT/BAUD RATE	3-1
3.2	PROTOCOL	3-1
3.3	MESSAGE FORMAT	3-1
3.4	ERROR CONDITIONS	3-4

1 OPERATION MODE

This mode covers day-to-day operation of the Indicator.

1.1 FRONT PANEL

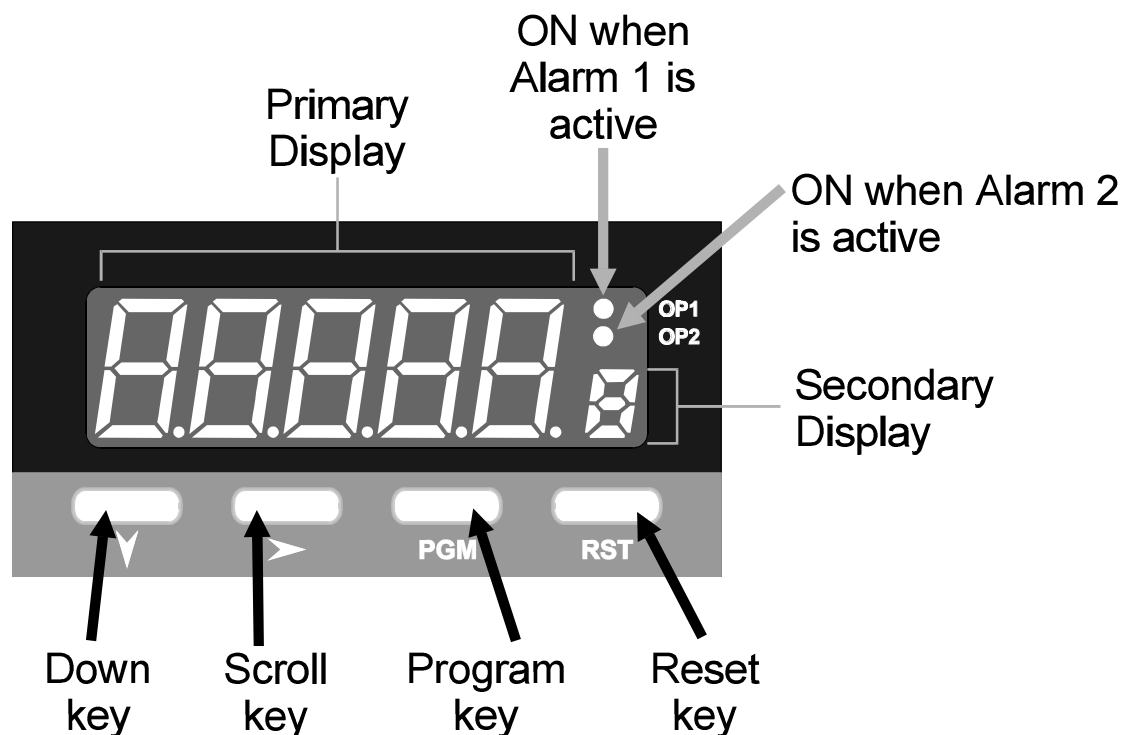

Key/Display/Indicator	Function
Down key (▼)	In Edit Mode, decrements the flashing digit in the Primary Display.
Scroll key (➤)	Puts Indicator into Edit Mode; in Edit Mode, selects digit to be altered (selected digit is flashing) in Primary Display. Wrap-around occurs from right-most digit to left-most digit.
Program Key (PGM)	Selects parameter to be viewed/edited. In Edit Mode, confirms changed parameter value.
Reset key (RST)	If the process variable is displayed, resets the latched Alarm 1. If the Maximum (High) Value, Minimum (Low) Value or Alarm 1 Elapsed Time is displayed, resets the displayed parameter.
Down (▼) and Scroll (➤) keys	If pressed simultaneously in Edit Mode, will abort the Edit operation and will restore the parameter to its initial value.
Primary Display	Normally displays the process variable value. Displays other Operation Mode parameters when the Program (PGM) key is used. If the Help Facility is enabled (see Subsection 2.4), this display shows the parameter description for three seconds before displaying the parameter value.
Secondary Display	Shows a single-character identifier for the parameter value being displayed (blank for process variable).
OP1 indicator	ON when Alarm 1 is active.
OP2 indicator	ON when Alarm 2 is active.

1.2 PARAMETER SEQUENCE

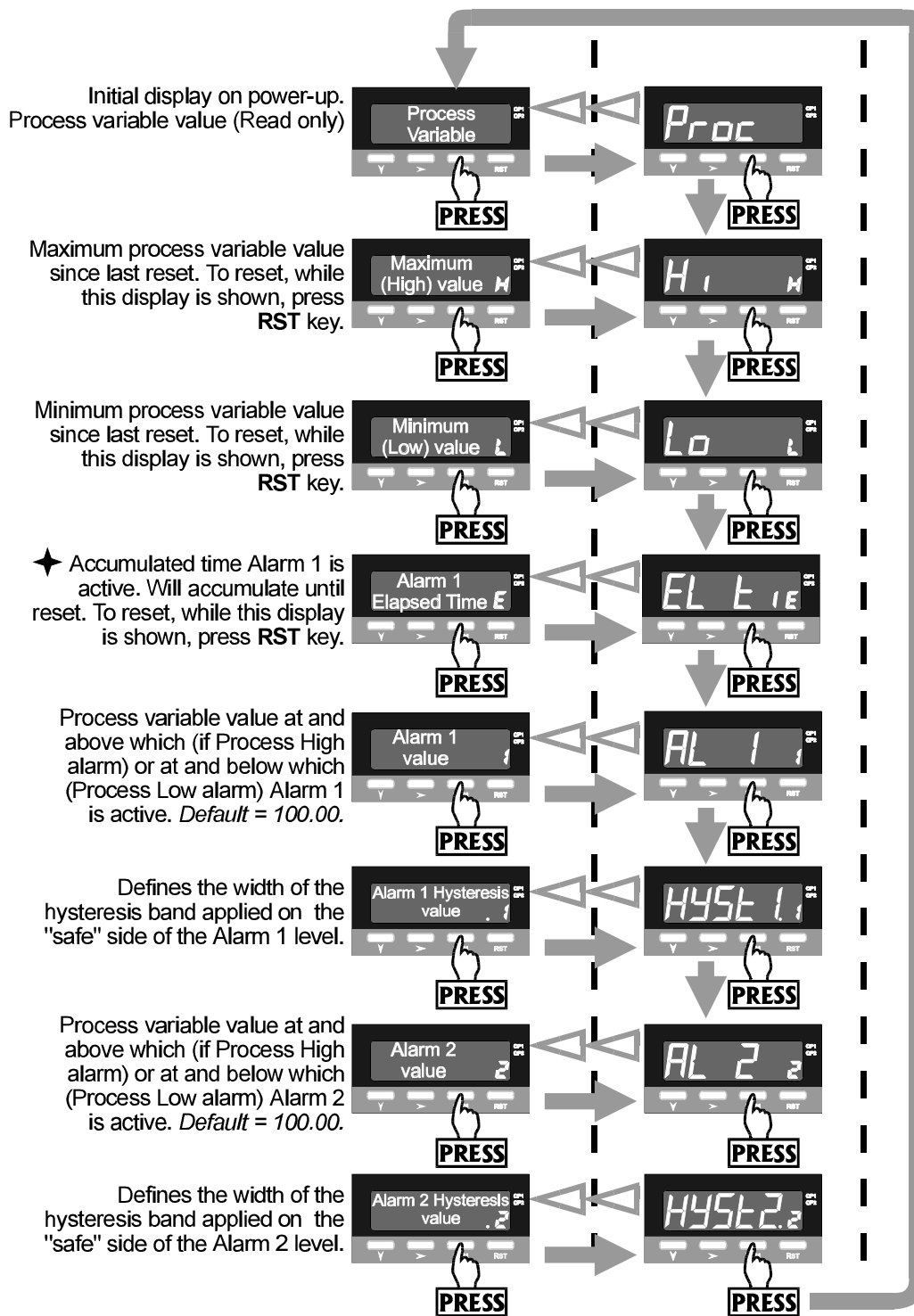

★ This value is displayed in the format mm.ss (mm = minutes, ss = seconds) up to 99 minutes 59 seconds and then in the format mmm.s (mmm = minutes, s = tens of seconds).

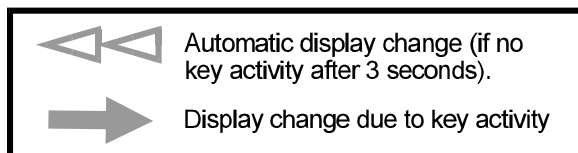

NOTE: These displays will not appear if the Help function is disabled. The display sequence is then one of parameter values only, each identified by a single character in the secondary display.

1.3 INPUT OVER-RANGE OR UNDER-RANGE

If the input becomes over-range or under-range, the primary display will show:



Process Variable Over-Range
Process variable is greater than the input maximum full scale value



Process Variable Under-Range
Process variable is less than the input minimum full scale value

The display will disappear when the input returns within the input scale range.

1.4 SENSOR BREAK

This indicates that there is a break in the input sensor circuit.



Sensor Break
Unit has not received an input signal for two seconds.

1.5 CHANGING AN ALARM VALUE

① Select display of required alarm value:



②



PRESS

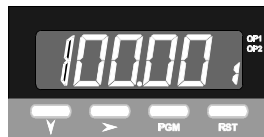
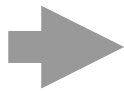

Left-most digit flashes

③



Use Down key to change value of flashing digit, if required.



④



PRESS



Next digit flashes

⑤ Repeat Steps 3 and 4 for each digit, as required.

⑥ When adjustment is complete, confirm new value:
All digits will stop flashing.



PRESS

1.6 RESETTING A LATCHED ALARM

If Relay 1 is configured to act as a latched Alarm 1 relay, when this alarm is active, it can be reset by selecting the process variable display and then pressing the Reset (RST) key. *The alarm will not be reset if the alarm condition exists at the time reset is attempted.*

1.7 ALARM HYSTERESIS

The Alarm Hysteresis parameter applies a hysteresis band on the “safe” side of the Alarm value. The effect of the hysteresis value (a percentage of input span) on the operation of the different types of alarm is illustrated below:

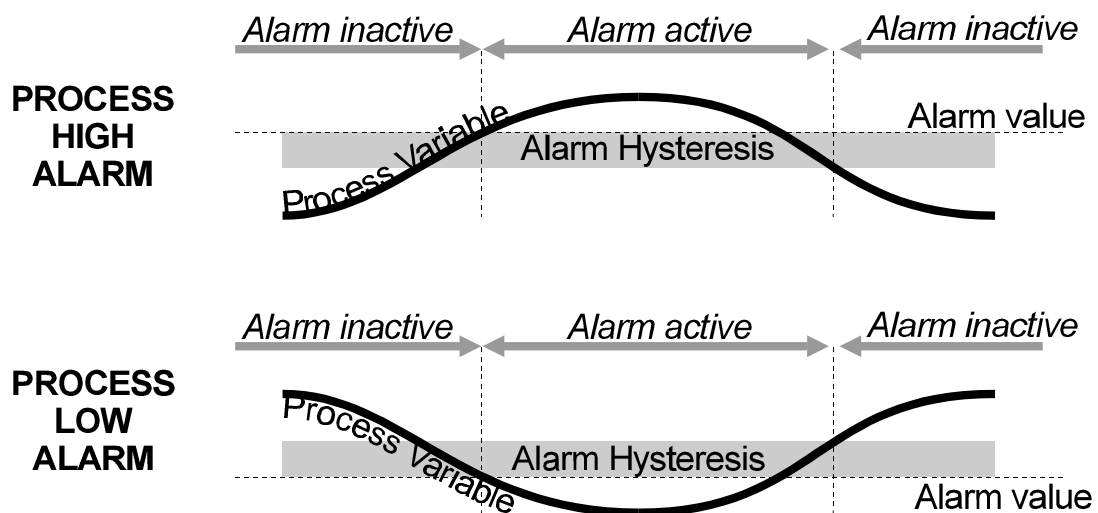

1.8 SUMMARY OF PARAMETER IDENTIFIERS (SECONDARY DISPLAY)

Secondary Display	Displayed Parameter
Blank	Process variable
	Maximum (High) value
	Minimum (Low) value
	Alarm 1 Elapsed Time
	Alarm 1 value
	Alarm 1 Hysteresis value
	Alarm 2 value
	Alarm 2 Hysteresis value

2.2.2 With Help Facility Disabled

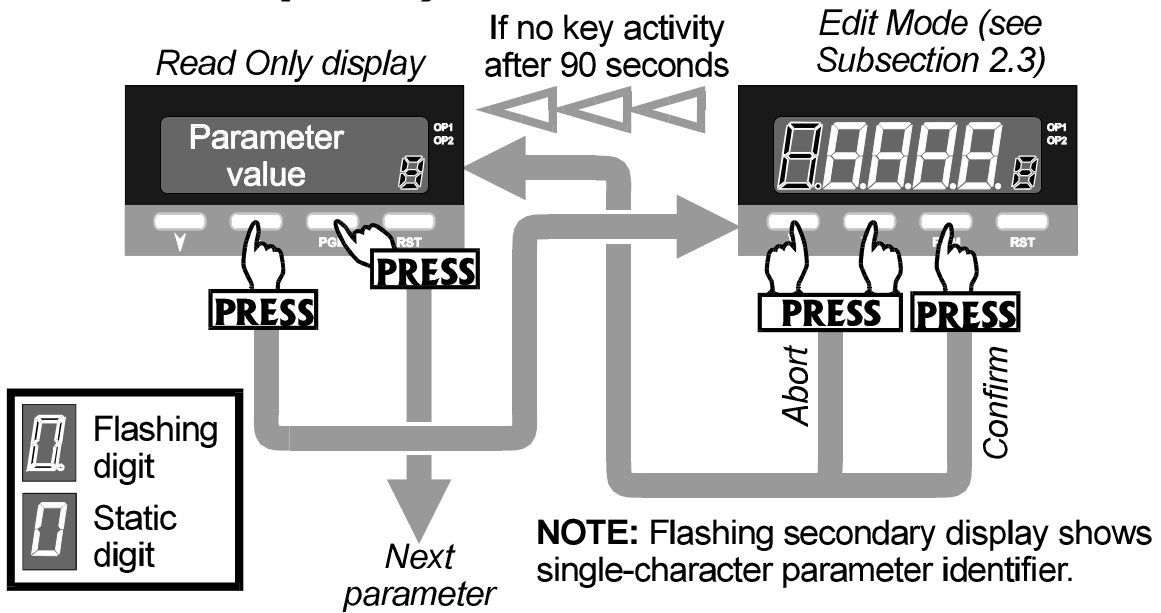

2.3 EDITING THE DISPLAYED PARAMETER (EDIT MODE)

- ① Select required parameter display (see Subsection 2.2.2 or 2.2.3 as appropriate).

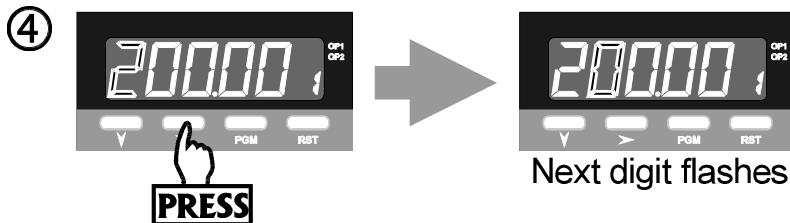
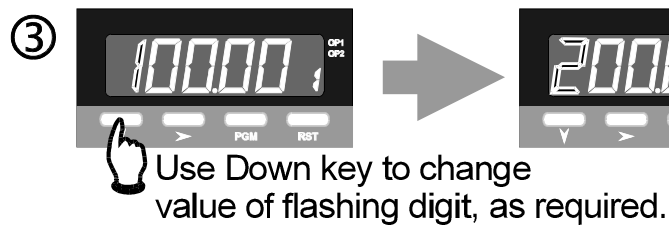
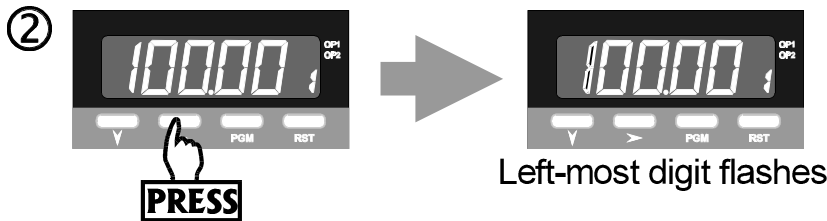



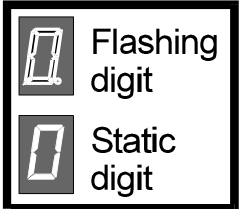























- ⑤ Repeat Steps 3 and 4 for each digit, as required.
- ⑥ Confirm new value or Abort Edit operation (see Subsection 2.2.2 or 2.2.3 as appropriate).



2.4 PARAMETER SEQUENCE

The Program Mode parameter sequence is as follows:

Parameter Description (Primary Display)	Identifier	Parameter	Description	Adjustment Range	Default
		Re-transmission Scale Minimum	The lower end of the linear scale for the re-transmission output, expressed as the value corresponding to the minimum output signal.	-19999 to 99999	-19999
		Re-transmission Scale Maximum	The upper end of the linear scale for the re-transmission output, expressed as the value corresponding to the maximum output signal.	-19999 to 99999	99999
		Process Variable Offset	Corrects a known offset of the input in order to display more accurately the process value.	-19999 to 99999	0.00
		Input Filter Time Constant	Filters the input over a user-definable time period to minimise the effect on the process variable of any extraneous impulses	0.0 (OFF) to 100.0	2.0
		Communications Address	The unique serial communications address of the instrument.	1 to 99	1
		Baud Rate	Serial communications speed	1200, 2400, 4800 or 9600	4800
		Display Colour Change	Defines the colour of the primary and secondary displays prior to/after the preset value (e.g. Alarm level) is reached.	 Red  Green  Green to Red  Red to Green	Green to Red
		Alarm Lock	Enables/disables the changing of alarm values via the front panel.	 Enabled  Disabled	Enabled
		Help Prompt	Determines whether the Primary Display shows the parameter description for 3 seconds before a parameter value is shown.	 Yes  No	Yes

3 SERIAL COMMUNICATIONS

The Serial Communications option is a standard RS485 communications link. Up to 32 standard RS485 loads may be presented to a single loop on this link. Each Indicator presents $\frac{1}{4}$ standard, therefore up to 128 may be connected to a single loop (ignoring the load presented by the master device). However, addresses are restricted to the range 1 to 99.

3.1 DATA FORMAT/BAUD RATE

Data format is fixed at one start bit, seven data bits, 1 parity bit (even parity) and 1 stop bit i.e. a 10-bit data word. Baud rates supported are 1200, 2400, 4800 and 9600. The half-duplex line turn-round time is fixed at 6ms regardless of Baud rate. The maximum inter-character delay is 120ms. The No Reply timeout is 2 seconds.

Data is expressed as a five-digit signed hexadecimal number in which the following characters are permitted:

0 1 2 3 4 5 6 7 8 9 A B C D E F

Note that all the non-numeric characters are upper case. The detection of any characters other than these will be regarded as a syntax error. Where a value carries a decimal point, the point position is implicit and the responsibility for interpreting it lies with the user.

3.2 PROTOCOL

The protocol operates on a single master basis only. All communication is initiated by the master device.

The communications addresses available are in the range 1 - 99. Address 0 is used for broadcast Parameter Write operation messages. When a message is broadcast, the receiving instruments will attempt to implement the instruction but will not reply.

3.3 MESSAGE FORMAT

Each message starts with a Start of Message character (L) and finishes with an End of Message character (*). A reply from the addressed instrument will contain either a positive acknowledgement or a negative acknowledgement. A positive acknowledgement has the character A immediately preceding the End of Message character; a negative acknowledgement has the character N immediately preceding the End of Message character.

There are three message formats; they permit instrument identification, Parameter Read operations and Parameter Write operations.

3.3.1 Form 1 Message

The master device sends a Form 1 message to ascertain whether a specific communications address is occupied by an instrument. If there is an instrument at that address, a reply (with a positive acknowledgement) is received. If there is no instrument at that address or if there is a communications link failure, no reply is received. The message from the master device is of the form:

$$Laa??^*$$

where *aa* is the address (a two-digit hexadecimal number). The reply from the addressed instrument is of the form:

$$Laa?A^*$$

where *aa* is the same address as in the received message.

3.3.2 Form 2 Message

This message implements a Parameter Read operation. The message from the master device is of the form:

$$Laap?^*$$

where *aa* is the address (a two-digit hexadecimal number)

p is a single-character parameter identifier (see Table 3-1)

The reply, if the Parameter Read operation is successful, is of the form:

$$LaapnnnnnA^*$$

where *aa* is the same address as in the received message

p is a single-character parameter identifier (see Table 3-1)

nnnnn is the data (a five-digit hexadecimal number)

If the specified parameter is invalid (e.g. not applicable to the addressed instrument), the reply is of the form:

$$Laap00000A^*$$

where *aa* is the same address as in the received message

p is a single-character parameter identifier (see Table 3-1)

3.3.3 Form 3 Message

This message implements the Parameter Write operation either on a single addressed instrument (address in the range 1 - 99) or broadcast to all instruments connected to the master device (i.e. using address 00). Note that, with the broadcast message, each slave instrument does not generate a reply. The message from the master device is of the form:

$$Laapnnnnn^*$$

where aa is the address (a two-digit hexadecimal number)

p is a single-character parameter identifier (see Table 3-1)

$nnnn$ is the value to be written (a five-digit hexadecimal number)

The reply for a successful Parameter Write operation is of the form:

$$LaapnnnnnA^*$$

where aa is the same address as in the received message

p is a single-character parameter identifier (see Table 3-1)

$nnnn$ is the value written (a five-digit hexadecimal number). In cases in which this parameter does not exist or is not applicable for the slave instrument, this value is 00000.

If a valid parameter is specified with an invalid value or an error condition is encountered, the reply is of the form:

$$LaapnnnnnN^*$$

where aa is the same address as in the received message

p is a single-character parameter identifier (see Table 3-1)

$nnnn$ indicates the error condition:

Value	Error Condition
FFFFF	Value under-range
7FFFF	Value over-range
7FFFE	Sensor Break detected
00001	Read Only parameter
00000	Illegal value

Table 3-1 Parameter Identifiers and Adjustment Ranges

Identifier	Hex.	Parameter	Adjustment Range
:	3A	Process Variable	Read Only (–19999 to 9999)
<	3C	Maximum Process Variable	Read Only (–19999 to 9999)
=	3D	Minimum Process Variable	Read Only (–19999 to 9999)
>	3E	Elapsed Alarm 1 Time	Read Only (0 to 60000)
@	40	Reset Max. PV	Write resets; Read always 0
A	41	Reset Min. PV	Write resets; Read always 0
B	42	Reset Elapsed Alarm 1 Time	Write resets; Read always 0
D	44	Reset Latched Alarm 1	Write resets; Read always 0
E	45	Alarm 1 value	Range Max. To Range Min.
F	46	Alarm 2 value	Range Max. To Range Min.
]	5D	Re-transmitted Scale Min.	–19999 to Re-trans. Scale Max.
^	5E	Re-transmitted Scale Max.	Re-trans. Scale Min. To 99999
_	5F	Process Variable Offset	0 to Range Span
'	60	Input Filter	0 to 1000 (0.0 to 100.0s)
a	61	Colour	0 to 3 (0 = Red, 1 = Green, 2 = Green/Red, 3 = Red/Green)
b	62	Alarm Lock	0 (lock enabled), 1 (lock disabled)
c	63	Help level	0 (Help enabled), 1 (Help disabled)

3.4 ERROR CONDITIONS

If a slave device detects a syntax error or parity error, it will not reply to the message; the master device should make up to two retries, applying the two-second No Reply timeout in each case.

Parameter Read operations with parameter identifiers which are in the legal range but which are not applicable to the addressed instrument will have no effect on any parameter values and a positive acknowledgement will be returned.

Parameter Write operations with parameter identifiers which are outside the legal range will be considered to be syntax errors; no reply will be generated.

Parameter Write operations in which the specified parameter is valid but the specified value is invalid will generate a negative acknowledgement.

$\frac{1}{8}$ -DIN DUAL COLOUR DISPLAY TEMPERATURE INDICATOR

Product Manual

Contents - Volume II

The procedures described in this Volume must be undertaken only by technically-competent servicing personnel.

1	INSTALLATION	1-1
1.1	UNPACKING	1-1
1.2	PANEL-MOUNTING	1-1
1.3	CONNECTIONS AND WIRING	1-3
2	INTERNAL LINKS AND SWITCHES	2-1
2.1	REMOVING THE INDICATOR FROM ITS HOUSING	2-1
2.2	REMOVING/REPLACING THE RELAY 2/LINEAR OUTPUT OPTION PCBs	2-3
2.3	REMOVING/REPLACING THE RS485 SERIAL COMMUNICATIONS OPTION PCB/DIGITAL INPUT OPTION PCB	2-3
2.4	REPLACING THE INSTRUMENT IN ITS HOUSING	2-4
2.5	SELECTION OF LINEAR (RE-TRANSMISSION) OUTPUT RANGE	2-4
3	CONFIGURATION MODE	3-1
3.1	ENTRY/EXIT	3-1
3.2	PARAMETER SELECTION	3-1
3.3	EDITING THE DISPLAYED PARAMETER	3-2
3.4	PARAMETER SEQUENCE	3-3
4	SERIAL COMMUNICATIONS - CONFIGURATION MODE	4-1

Appendices

A	PRODUCT SPECIFICATION	A-1
A.1	DISPLAY	A-1
A.2	SENSOR INPUT	A-1
A.3	DIGITAL INPUT (OPTION)	A-3
A.4	TRANSISTOR OUTPUTS	A-3
A.5	RELAY 1 OUTPUT	A-3
A.6	RELAY 2 OUTPUT (OPTION)	A-4
A.7	LINEAR (RE-TRANSMITTED PV) OUTPUT (OPTION)	A-4
A.8	SERIAL COMMUNICATIONS (OPTION)	A-4
A.9	PERFORMANCE	A-5
A.10	ENVIRONMENTAL	A-7
A.11	PHYSICAL	A-7

1 INSTALLATION

1.1 UNPACKING

1. Remove the Indicator from its packing. The indicator is supplied with a panel gasket and push-fit fixing strap. Retain the packing for future use.
2. Examine the delivered items for damage or deficiencies. If any is found, notify the carrier immediately.

1.2 PANEL-MOUNTING

The panel on which the Indicator is to be mounted must be rigid and may be up to 6mm (0.25 inches) thick. The cut-out required for a single Indicator is shown in Figure 1-1. Several indicators may be mounted side-by-side in a single cut-out. For n Indicators mounted side-by-side, the cut-out dimensions would be $(48n - 4)$ millimetres or $(1.89n - 0.16)$ inches. The main dimensions of the Indicator are shown in Figure 1-2.

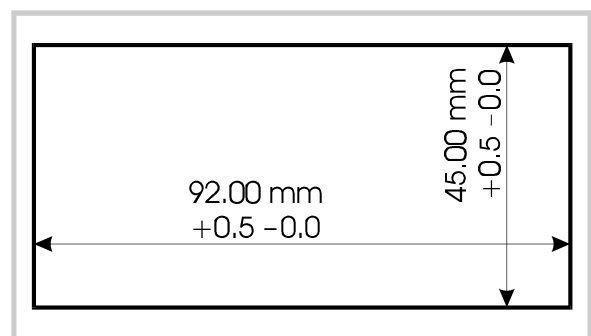

Figure 1-1 Panel Cut-out

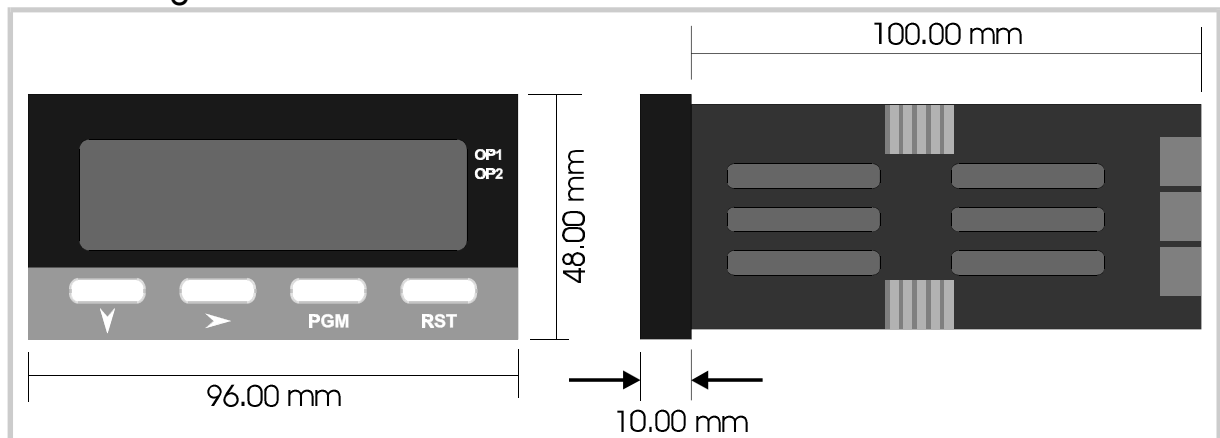

Figure 1-2 Main Dimensions

The panel-mounting procedure is shown in Figure 1-3.

CAUTION: Do not remove the panel gasket, as this may result in inadequate clamping of the instrument in the panel.

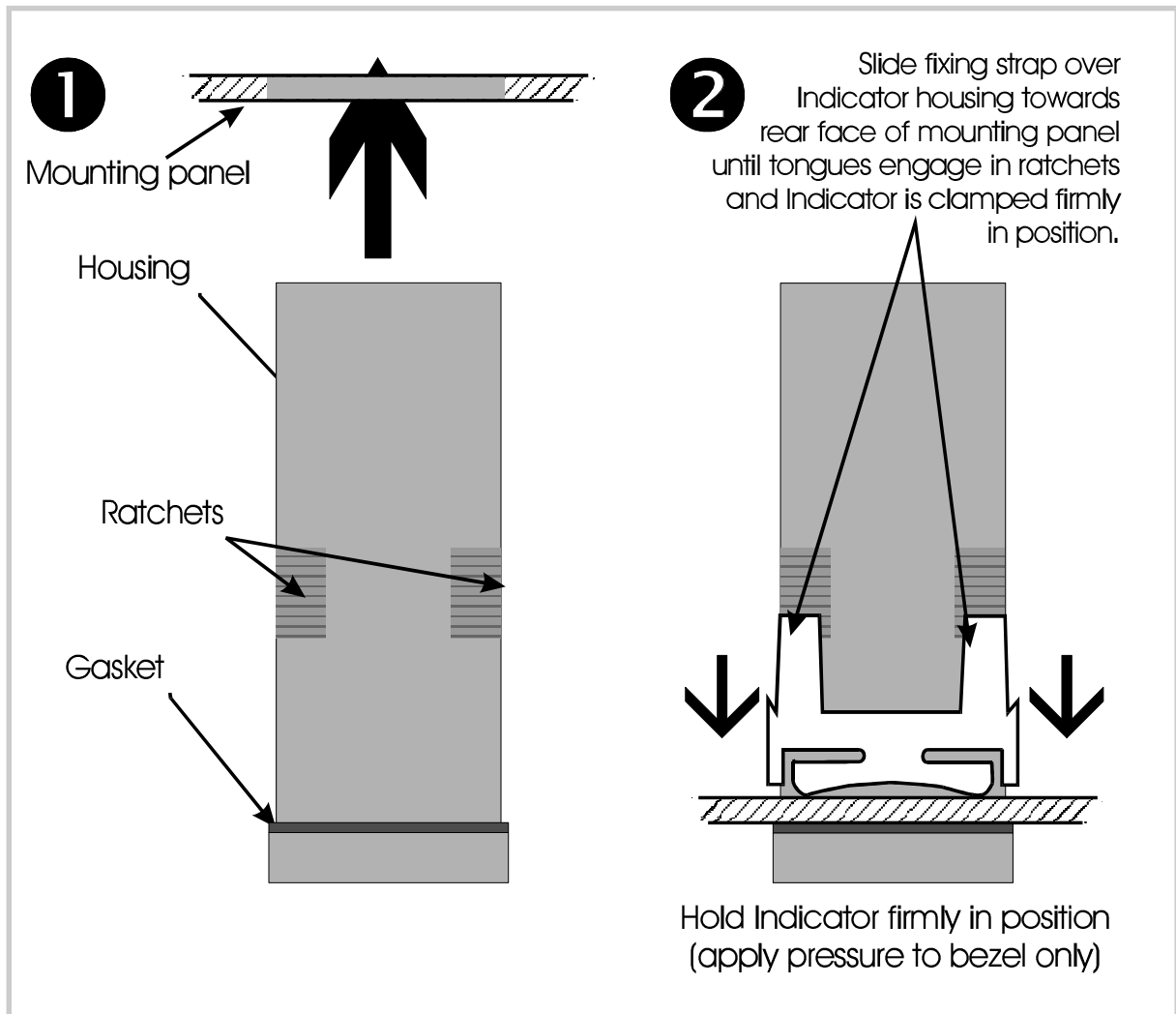

Figure 1-3 Panel-mounting

1.3 CONNECTIONS AND WIRING

The rear terminal connections are shown in Figure 1-4.

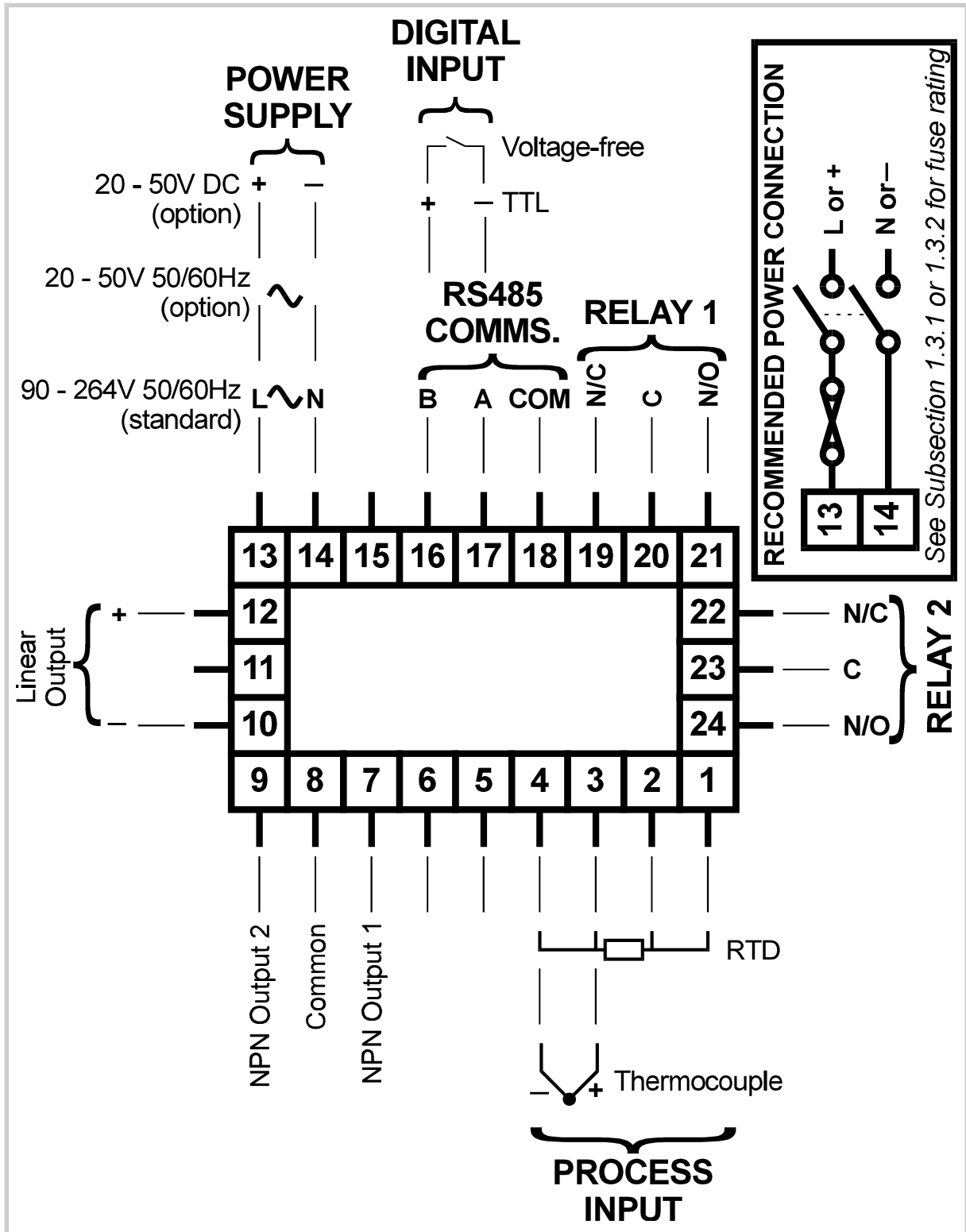

Figure 1-4 Rear Terminal Connections

1.3.1 Mains (Line) Supply

The Indicator will operate on 90 - 264V AC 50/60Hz mains (line) supply. The power consumption is approximately 4 watts.

CAUTION: This equipment is designed for installation in an enclosure which provides adequate protection against electric shock. Local regulations regarding electrical installation should be rigidly observed. Consideration should be given to prevention of access to the power terminations by unauthorised personnel. Power should be connected via a two-pole isolating switch (preferably situated near to the equipment) and a 1A fuse, as shown in Figure 1-4.

If the Indicator has relay outputs in which the contacts are to carry mains (line) voltage, it is recommended that the relay contact mains (line) supply should be switched and fused in a similar manner but should be separate from the Indicator mains (line) supply.

1.3.2 20 - 50V AC/DC Supply

Power should be connected via a two-pole isolating switch and a 315mA slow-blow (anti-surge Type T) fuse. With this option fitted, the Indicator will accept 20 - 50V AC @ 50/60Hz or 20 - 50V DC in the polarity shown in Figure 1-4.

1.3.3 Thermocouple Input

The correct type of thermocouple extension leadwire or compensating cable should be used for the entire distance between the Indicator and the thermocouple, ensuring that the correct polarity is observed throughout. The positive leg should be connected to Terminal 3 and the negative leg to Terminal 4. Joints in the cable should be avoided, if possible.

NOTE: Do not run thermocouple cables adjacent to power-carrying conductors. If the wiring is run in a conduit, use a separate conduit for the thermocouple wiring. If the thermocouple is grounded, this must be done at one point only. If the thermocouple extension lead is shielded, the shield must be grounded at one point only.

1.3.4 RTD Inputs

Three-wire or four-wire RTDs may be used. For three-wire RTDs, connect the resistive leg of the RTD to Terminal 2, the common legs to Terminals 3 and 4 and a link between Terminals 1 and 2. For four-wire RTDs, connect the resistive legs to Terminals 1 and 2 and the common legs to terminals 3 and 4.

1.3.5 Digital Input Option

Terminals 16 and 17, when this option is fitted, may be used for external selection of the Security facility) which allows/prevents entry into Program Mode from the front panel. These terminals may be connected to (a) the voltage-free contacts of a switch or relay, or (b) a TTL-compatible voltage. With the Security option configured (see Subsection 3.4), security selection is as follows:

Voltage-free Operation:	Contacts open - Entry into Program Mode prohibited
	Contacts closed - Entry into Program Mode permitted
TTL-compatible Operation:	>2.0V - Entry into Program Mode prohibited
	<0.8V - Entry into Program Mode permitted.

NOTE: This option and the Serial Communications option are mutually exclusive.

1.3.6 Relay Outputs

Relay 1 is a standard feature; it is tied to Alarm 1. Relay 2 is an option; when fitted, it is tied to Alarm 2. The contacts are rated at 2A resistive @ 120/240V AC.

1.3.7 Linear Output

This option provides a 10-bit linear output signal representing the process variable. The range of this output is selectable in Configuration Mode (see Subsection 3.4).

1.3.8 Serial Communications Option

The cable used should be suitable for data transfer at the selected rate (1200, 2400, 4800 or 9600 Baud) over the required distance. Transmitters/receivers conform to the recommendations in the EIA Standard RS485.

The "A" terminal on the Indicator (Terminal 17) should be connected to the "A" terminal on the master device; the "B" terminal on the Indicator (Terminal 16) should be connected to the "B" terminal on the master device; the "Common" terminal on the Indicator (Terminal 18) should be connected to the "Common" terminal on the master device.

Where several Indicators are connected to one master port, the master port transceiver in the active state should be capable of driving a load of $120\text{k}\Omega$ per Indicator; the master port transceiver in the passive state must have pull-up/pull-down resistors of sufficiently low impedance to ensure that it remains in the quiescent state whilst supplying up to $\pm 100\mu\text{A}$ each to the Indicator transceivers in the high impedance state.

NOTE This option and the Digital Input option are mutually exclusive.

2 INTERNAL LINKS AND SWITCHES

2.1 REMOVING THE INDICATOR FROM ITS HOUSING

CAUTION: Before removing the Indicator from its housing, ensure that all power has been removed from the rear terminals.

To remove the Indicator from its housing, simply grip the side edges of the front panel (there is a finger grip on each edge) and pull the instrument forward. This will release the rear terminals from their connectors in the housing and will give access to the PCBs. Take note of the orientation of the instrument for subsequent replacement in the housing. The positions of the PCBs in the Indicator are shown in Figure 2-1.

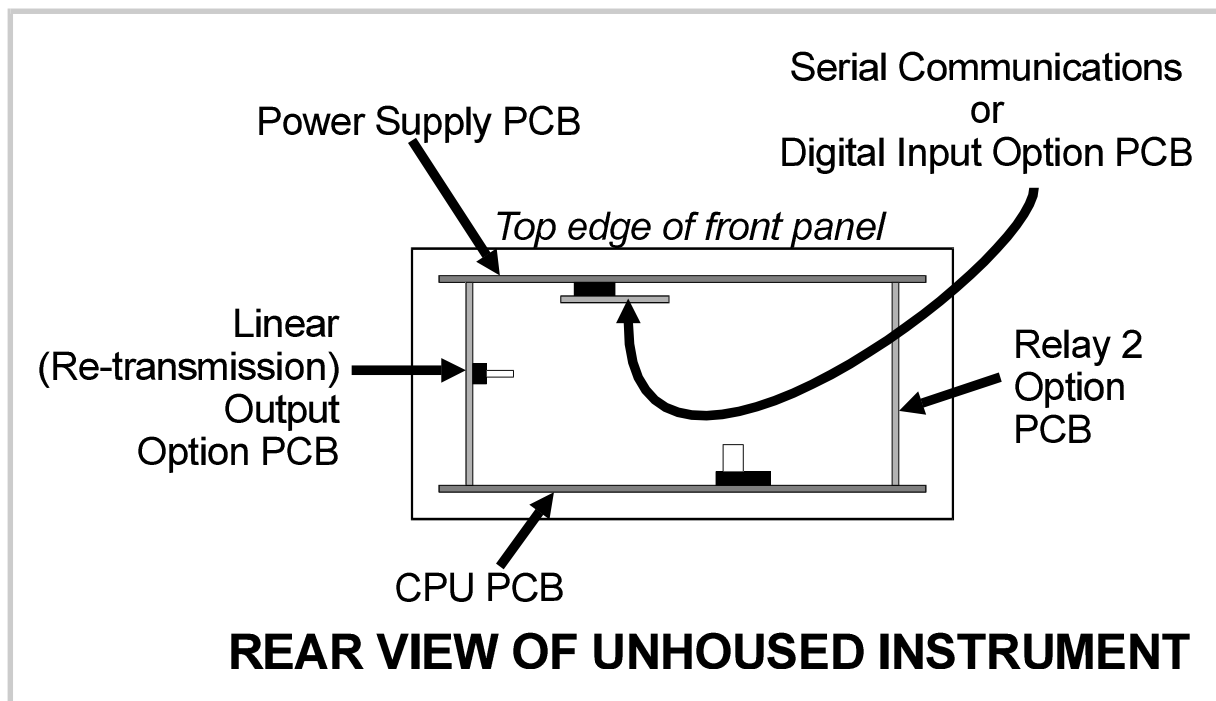

Figure 2-1 PCB Positions

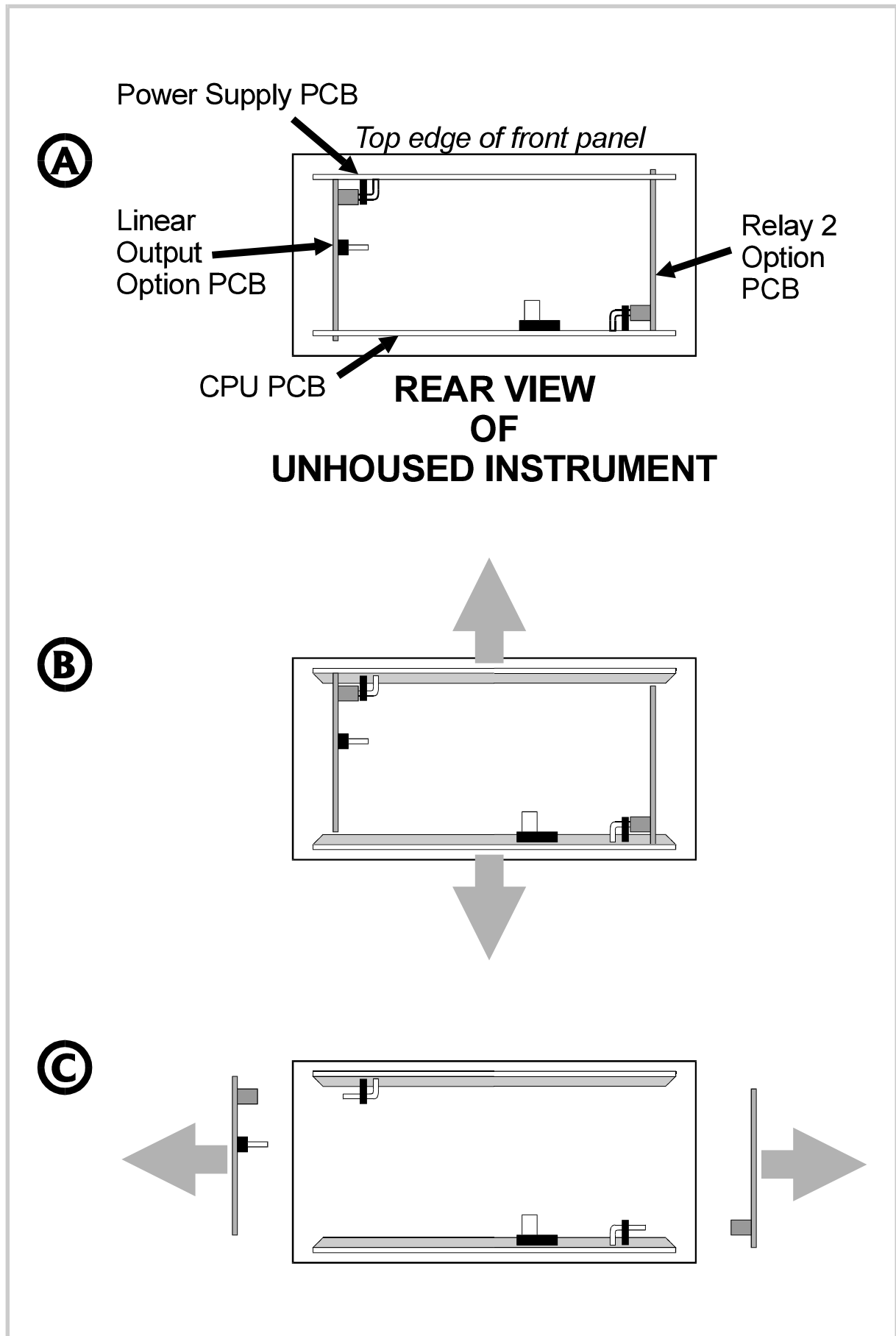

Figure 2-2 Removing the Relay 2/Linear Output Options PCBs

2.2 REMOVING/REPLACING THE RELAY 2/LINEAR OUTPUT OPTION PCBs

With the Indicator removed from its housing:

1. Gently push the rear ends of the CPU PCB and Power Supply PCB apart slightly, until the tongues on each of the Relay 2 Option PCB and the Linear Output Option PCB become disengaged - see Figure 2-2B; the Relay 2 Option PCB tongues engage in holes in the Power Supply PCB and the Linear Output Option PCB tongues engage in holes in the CPU PCB.
2. Carefully pull the required Option PCB (Relay 2 or Linear Output) from its connector (the Relay 2 Option PCB is connected to the CPU PCB and the Linear Output PCB is connected to the Power Supply PCB) - see Figure 2-2C. Note the orientation of the PCB in preparation for its replacement.

Adjustments may now be made to the link jumpers on the Linear Output Option PCB (to select the output range - see Subsection 2.5).

2.3 REMOVING/REPLACING THE RS485 SERIAL COMMUNICATIONS OPTION PCB/DIGITAL INPUT OPTION PCB

The Serial Communications Option PCB or the DC Input Option PCB (the two are mutually exclusive) is mounted on the inner surface of the Power Supply PCB and can be removed from the unboxed Instrument by pulling the Option PCB towards the rear of the Power Supply PCB. Figure 2-3 illustrates the removal/replacement procedure. *It is not necessary to remove the Relay 2/Linear Output Option PCBs to perform this procedure.*

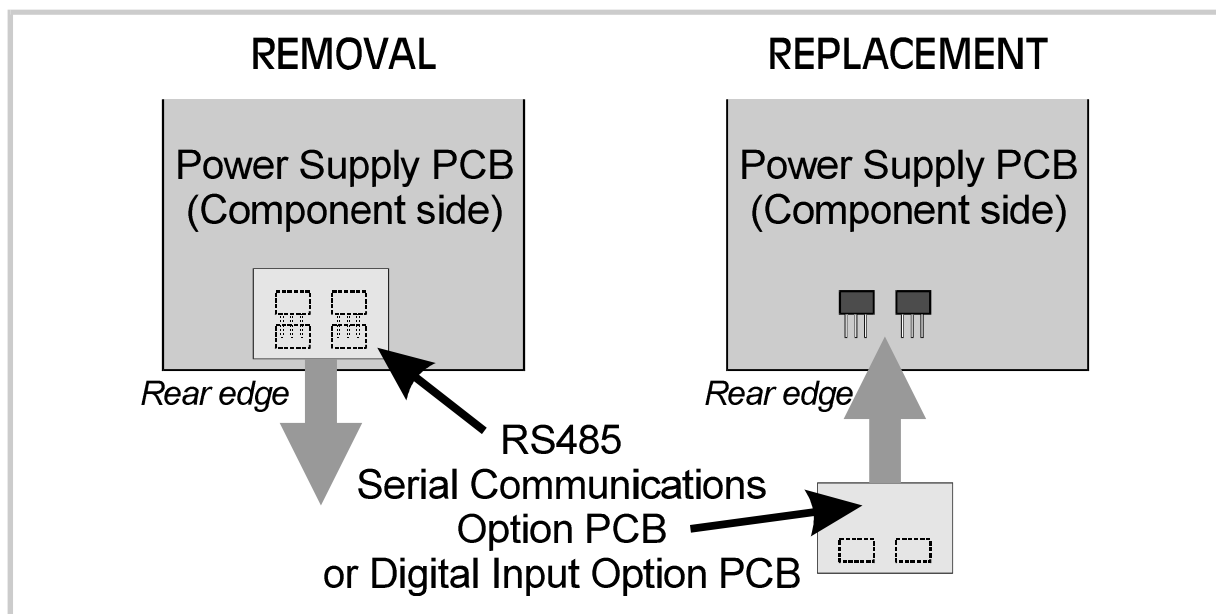

Figure 2-3 Removing/Replacing the Serial Communications/Digital Input Option PCB

2.4 REPLACING THE INSTRUMENT IN ITS HOUSING

To replace the instrument in its housing, simply align the CPU PCB and Power Supply PCB with their guides and connectors in the housing and slowly but firmly push the instrument into position.

CAUTION: Ensure that the instrument is correctly orientated. A stop will operate if an attempt is made to insert the instrument in the wrong orientation i.e. upside-down. This stop must not be over-ridden.

2.5 SELECTION OF LINEAR (RE-TRANSMISSION) OUTPUT RANGE

If the Linear Output Option PCB is fitted, link jumpers on that PCB are used to select the output range (see Figure 2-4 and Table 2-1).

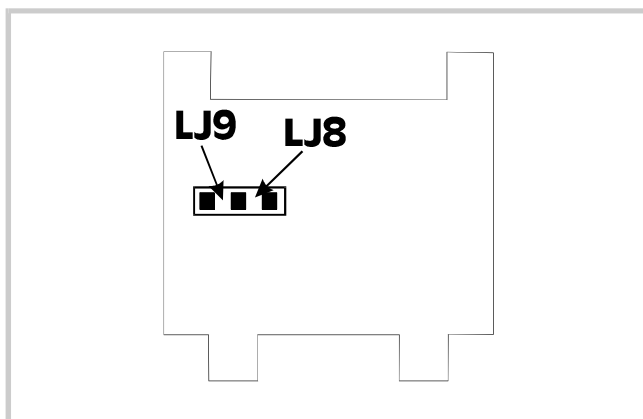

Figure 2-4 Linear Output Option PCB

Table 2-1 Linear Output Range Selection

Output Range	Link Jumper Fitted
0 - 10V DC	LJ8
0 - 20mA DC	LJ9
0 - 5V DC	LJ8
4 - 20mA DC	LJ9

3 CONFIGURATION MODE

3.1 ENTRY/EXIT

Indicator initially in Operation Mode



NOTE: In Configuration Mode, the secondary display flashes continuously and shows a single-character which identifies the displayed parameter.

HOLD DOWN FOR 3 SECONDS

Use these keys in the same way to exit from Configuration Mode.

3.2 PARAMETER SELECTION

3.2.1 With Help Facility Enabled

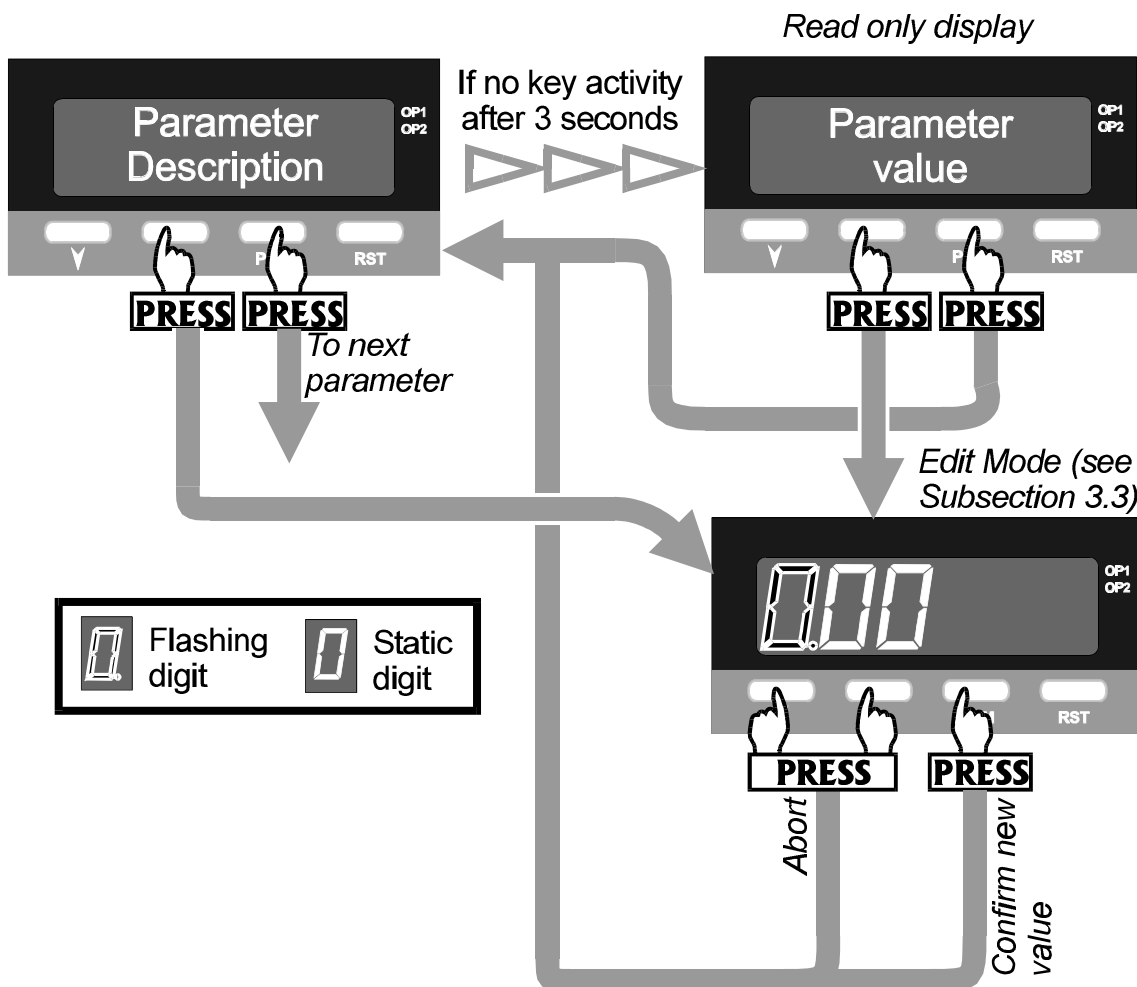

3.2.2 With Help Facility Disabled

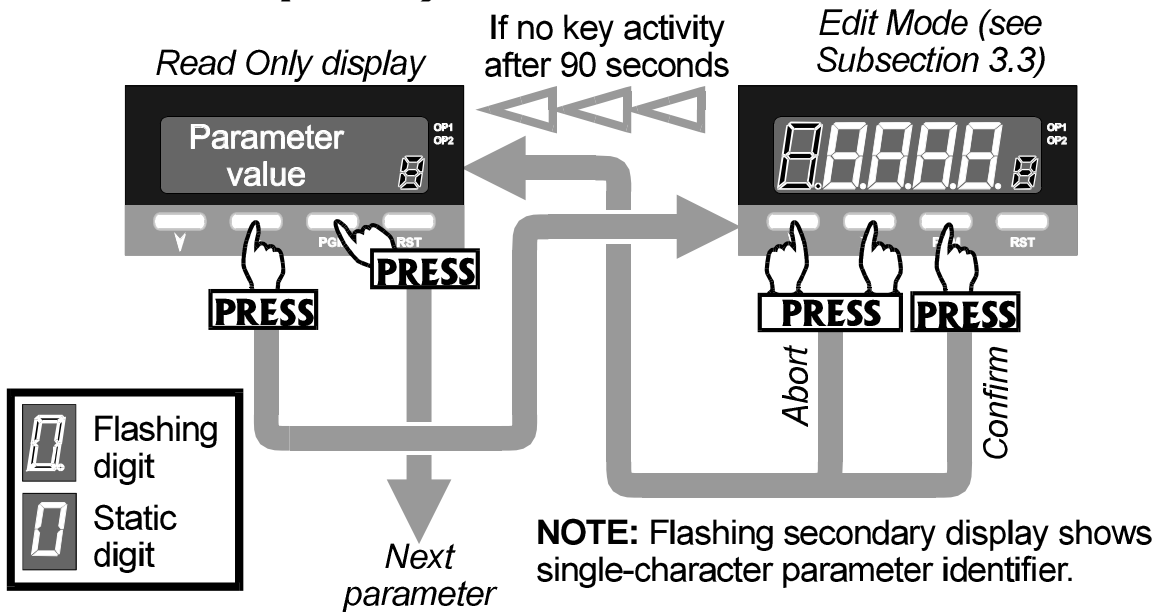

3.3 EDITING THE DISPLAYED PARAMETER

- ① Select required parameter display (see Subsection 3.2.2 or 3.2.3 as appropriate).

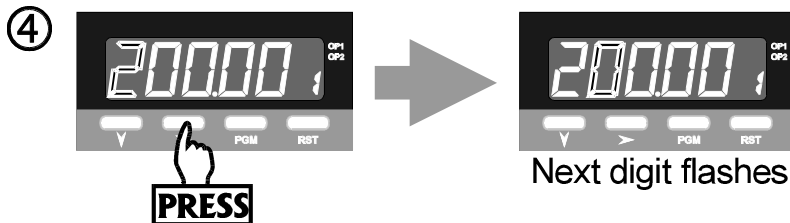
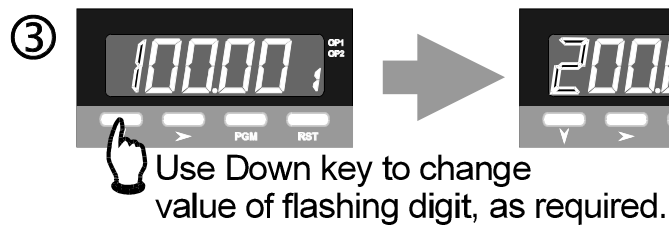
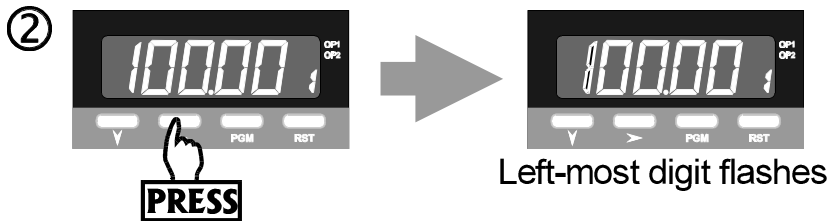

- ⑤ Repeat Steps 3 and 4 for each digit, as required.
- ⑥ Confirm new value or Abort Edit operation (see Subsection 3.2.2 or 3.2.3 as appropriate).

3.4 PARAMETER SEQUENCE

Parameter Description (Primary Display)	Identifier	Parameter	Description	Adjustment Range	Default
		Input Range	Selects the input sensor type, resolution and display scale (°C or °F) by means of a code number.	See Table 3-1.	
		Range Trim High	Adjusts the maximum range value of the input type selected.	Range Trim Low (see below) to Range Max. (see Table 3-1).	Range Max.
		Range Trim Low	Adjusts the minimum range value of the input type selected.	Range Min. (See Table 3-1) to Range Trim High (see above)	Range Min.
		Power Supply Frequency	Applicable to DC-powered units only, this must be set to the mains (line) frequency for the site in order to ensure proper filtering of the input signal.	50Hz 60Hz	60Hz
		Alarm 1 Type	Defines the action of Alarm 1	Process High Process Low No alarm	Process High
		Alarm 2 Type	Defines the action of Alarm 2	Process High Process Low No alarm	No alarm
		Output 1 Usage	Determines how NPN Output 1 and Relay 1 operate.	Alarm 1, non-latching, direct action Alarm 1, non-latching, reverse action Alarm 1, latching, direct action Alarm 1, latching, reverse action Logical OR Alarm 1 & 2, direct action Logical OR Alarm 1 & 2, reverse action	Alarm 1 non-latching direct action

Parameter Description (Primary Display)	Identifier	Parameter	Description	Adjustment Range	Default
		Output 2 Usage	Determines how NPN Output 2 and Relay 2 operate.	Alarm 2, direct action Alarm 2, reverse action Logical OR Alarm 1 & 2, direct action Logical OR Alarm 1 & 2, reverse action	Alarm 2, direct action
		Re-transmission (Linear) Output	Selects the scale for the Re-transmission (Linear) Output	None 0 - 5V 1 - 5V 0 - 10V 2 - 10V 0 - 20mA 4 - 20mA	None
		Option Selection	Determines whether the Serial Communications Option or Digital Input Option is fitted	None Serial Comms. Digital Input	None

Table 3-1 Input Range Codes

Input Type	Range Code	Range Minimum	Range Maximum
Thermocouple Inputs			
J	100 (°C)	-200	1200
	101 (°F)	-328	2192
	110 (°C)	-128.0	537.0
	111 (°F)	-198.4	998.6
T	200 (°C)	-240	400
	201 (°F)	-400	752
	210 (°C)	-128.0	400.0
	211 (°F)	-198.4	752.0
K	300 (°C)	-240	1372
	301 (°F)	-400	2502
	310 (°C)	-128.0	537.0
	311 (°F)	-198.4	998.6
N	400 (°C)	0	1399
	401 (°F)	32	2550
B	500 (°C)	100	1824
	501 (°F)	212	3315
R	600 (°C)	0	1760
	601 (°F)	32	3200
S	700 (°C)	0	1760
	701 (°F)	32	3200
RTD Inputs			
3-wire	800 (°C)	-200	800
	801 (°F)	-328	1472
	810 (°C)	-128.0	537.0
	811 (°F)	-198.4	998.6
4-wire	900 (°C)	-200	800
	901 (°F)	-328	1472
	910 (°C)	-128.0	537.0
	911 (°F)	-198.4	998.6

4 SERIAL COMMUNICATIONS - CONFIGURATION MODE

This section is a supplement to the information provided in Volume I, Section 3 and describes the Read/Write communications operations which can be performed in Configuration Mode.

Table 4-1 Parameter Identifiers and Adjustment Ranges - Configuration Mode

Identifier	Hex.	Parameter	Adjustment Range
d	64	Enter Configuration Mode	Read: 0 - Not in Configuration Mode 1 - In Configuration Mode Write: 1 - Enter Configuration Mode
e	65	Exit Configuration Mode	Read: 0 - In Configuration Mode 1 - Not in Configuration Mode Write: 1 - Exit Configuration Mode
f	66	Input Type	For range of values, see Table 4-2.
g	67	Range Trim Maximum	Range Trim Minimum to Range Maximum (see Table 4-2)
h	68	Range Trim Minimum	Range Minimum (see Table 4-2) to Range Trim Maximum
i	69	Mains (Line) Frequency. (Applicable to DC-powered units only)	0 (50Hz) or 1 (60Hz)
j	6A	Alarm 1 Type	0 No alarm 1 Process High 2 Process Low
k	6B	Alarm 2 Type	0 No alarm 1 Process High 2 Process Low

Continued on next page ⇒⇒⇒⇒⇒

NOTE: All Configuration Mode parameters are Read Only when the instrument is not in Configuration Mode, Read/Write when the instrument is in Configuration Mode.

Table 4-1 Parameter Identifiers and Adjustment Ranges - Configuration Mode

Identifier	Hex.	Parameter	Adjustment Range
l	6C	Output 1 Use	0 Alarm 1 non-latching, direct action 1 Alarm 1 non-latching, reverse action 2 Alarm 1 latching, direct action 3 Alarm 1 latching, reverse action 4 Logical OR Alarm 1 & 2, direct action 5 Logical OR Alarm 1 & 2, reverse action
m	6D	Output 2 Use	0 Alarm 2, direct action 1 Alarm 2, reverse action 2 Logical OR Alarm 1 & 2, direct action 3 Logical OR Alarm 1 & 2, reverse action
n	6E	Select Re-transmission (Linear) Output Range	0 None 1 0 - 5V 2 1 - 5V 3 0 - 10V 4 2 - 10V 5 0 - 20mA 6 4 - 20mA

NOTE: All Configuration Mode parameters are Read Only when the instrument is not in Configuration Mode, Read/Write when the instrument is in Configuration Mode.

Table 4-2 Input Type Selection - Available Values

Input Type	Range Code	Range Minimum	Range Maximum	Hex. Value
Thermocouple Inputs				
J	100 (°C)	-200	1200	0
	101 (°F)	-328	2192	1
	110 (°C)	-128.0	537.0	2
	111 (°F)	-198.4	998.6	3
T	200 (°C)	-240	400	4
	201 (°F)	-400	752	5
	210 (°C)	-128.0	400.0	6
	211 (°F)	-198.4	752.0	7
K	300 (°C)	-240	1372	8
	301 (°F)	-400	2502	9
	310 (°C)	-128.0	537.0	0A
	311 (°F)	-198.4	998.6	0B
N	400 (°C)	0	1399	0C
	401 (°F)	32	2550	0D
B	500 (°C)	100	1824	0E
	501 (°F)	212	3315	0F
R	600 (°C)	0	1760	10
	601 (°F)	32	3200	11
S	700 (°C)	0	1760	12
	701 (°F)	32	3200	13
RTD Inputs				
3-wire	800 (°C)	-200	800	14
	801 (°F)	-328	1472	15
	810 (°C)	-128.0	537.0	16
	811 (°F)	-198.4	998.6	17
4-wire	900 (°C)	-200	800	18
	901 (°F)	-328	1472	19
	910 (°C)	-128.0	537.0	1A
	911 (°F)	-198.4	998.6	1B

APPENDIX A PRODUCT SPECIFICATION

A.1 DISPLAY

Type:	Red/green, seven-segment LED, five-digit primary display, one-digit secondary display.
Height:	0.71 inches (18mm) primary display 0.3 inches (7mm) secondary display
Annunciators:	Alarm 1 and Alarm 2 status.

A.2 SENSOR INPUT

Types:	Type B, J, K, N, S and T thermocouples Three-wire and four-wire RTD
Accuracy:	0.1% of span
Sample Rate:	Every 250mS.
Resolution:	14 bits.
Sensor Break Detection:	Detected within two seconds.
Input Ranges Available:	See Table A-1.

Table A-1 Input Type Selection - Available Values

Input Type	Range Code	Range Minimum	Range Maximum
Thermocouple Inputs			
J	100 (°C)	-200	1200
	101 (°F)	-328	2192
	110 (°C)	-128.0	537.0
	111 (°F)	-198.4	998.6
T	200 (°C)	-240	400
	201 (°F)	-400	752
	210 (°C)	-128.0	400.0
	211 (°F)	-198.4	752.0
K	300 (°C)	-240	1372
	301 (°F)	-400	2502
	310 (°C)	-128.0	537.0
	311 (°F)	-198.4	998.6
N	400 (°C)	0	1399
	401 (°F)	32	2550
B	500 (°C)	100	1824
	501 (°F)	212	3315
R	600 (°C)	0	1760
	601 (°F)	32	3200
S	700 (°C)	0	1760
	701 (°F)	32	3200
RTD Inputs			
3-wire	800 (°C)	-200	800
	801 (°F)	-328	1472
	810 (°C)	-128.0	537.0
	811 (°F)	-198.4	998.6
4-wire	900 (°C)	-200	800
	901 (°F)	-328	1472
	910 (°C)	-128.0	537.0
	911 (°F)	-198.4	998.6

A.3 DIGITAL INPUT (OPTION)

Type:	Voltage-free or TTL-compatible operation.
May be connected to:	External switch/relay contacts or TTL-compatible logic signal.
Maximum Input delay (open - closed or "1" - "0" transition):	1 second
Minimum Input delay (closed - open or "0" - "1" transition):	1 second

External Switch/Relay Contacts

Maximum Contact Resistance (Closure):	50
Minimum Contact Resistance (Open):	5000

External TTL-Compatible Logic Signal

Maximum Voltage (TTL) for "0":	0.8V
Minimum Voltage (TTL) for "0":	-0.6V
Minimum Voltage (TTL) for "1":	2.0V
Maximum Voltage (TTL) for "1":	24.0V

A.4 TRANSISTOR OUTPUTS

Type:	NPN open collector. Output tied to Alarm 1, Output 2 tied to Alarm 2.
-------	---

A.5 RELAY 1 OUTPUT

Contact Type:	Single pole double throw.
Rating:	5A resistive @ 120/240V AC

Lifetime: >500,000 operations at rated voltage/current.

Isolation: Inherent

A.6 RELAY 2 OUTPUT (OPTION)

Contact Type: Single pole double throw.

Rating: 5A resistive @ 120/240V AC

Lifetime: >500,000 operations at rated voltage/current.

Isolation: Inherent

A.7 LINEAR (RE-TRANSMITTED PV) OUTPUT (OPTION)

Ranges available: 0 - 5V, 1 - 5V, 0 - 10V, 2 - 10V, 0 - 20mA and 4 - 20mA.

Accuracy: 0.25% (mA @ 250W, V @ 2kW); degrades linearly to 0.5%.

Resolution: 8 bits in 250mS (10 bits in 1 second typically).

Update Rate: 4/second approximately.

Load Impedance: mA ranges - 500W max.
V ranges - 500W min.

A.8 SERIAL COMMUNICATIONS (OPTION)

Type: Serial asynchronous, UART to UART.

Data Format: Open ASCII; One start bit, even parity, seven data bits, one stop bit.

Physical Layer: RS485.

Maximum Number of Zones: 99.

Baud Rate: Selectable from 1200, 2400, 4800 and 9600 Baud.

A.9 PERFORMANCE

Reference Conditions

Ambient Temperature:	20°C ±2°C
Relative Humidity:	60 - 70%
Supply Voltage:	90 - 264V AC 50Hz
Source Resistance:	<10Ω for thermocouple input
Lead Resistance:	<0.1Ω/lead balanced (Pt100)

Performance Under Reference Conditions

Common Mode Rejection:	> 120dB at 50/60Hz giving negligible effect at up to 264V 50/60Hz.
Series Mode Rejection:	>500% of span (at 50/60Hz) causes negligible effect.

Thermocouple Inputs

Measurement Accuracy:	±0.05% typical, ±0.1% maximum, of span ±1LSD. NOTE: Reduced performance with Type "B" Thermocouple below 600°C (1112°F).
Linearisation Accuracy:	High resolution ranges - better than ±0.5°C Low resolution ranges - better than ±0.05°C
Cold Junction Compensation:	±0.3% typical, ±0.5% maximum.

RTD Inputs

Measurement Accuracy:	±0.02% typical, ±0.06% maximum, of span ±1LSD
Linearisation Accuracy:	High resolution ranges - better than ±0.5°C. Low resolution ranges - better than ±0.05°C.

Operating Conditions

Ambient Temperature:	0°C to 55°C
----------------------	-------------

Relative Humidity:	20% - 95% non-condensing
Source Resistance:	1000 Ω maximum (thermocouple)
Lead Resistance:	50 Ω per lead maximum balanced (Pt100)

Performance Under Operating Conditions

Temperature Stability:	0.005% of span/ $^{\circ}$ C change in ambient temperature.
Cold Junction Compensation (thermocouple only):	Better than $\pm 1^{\circ}$ C.

A.10 ENVIRONMENTAL

EMI Susceptibility:	Complies with EN50082-1:1992, EN50082-1:1995. NOTE: For RF electromagnetic fields (10V/m 80% AM 1kHz), the reading accuracy may be impaired by up to 3 $^{\circ}$ C in the frequency band 273 to 470MHz and by up to 1.4 $^{\circ}$ C in the frequency band 785 to 1000MHz.
EMI Emmissions:	Complies with EN50081-1:1992, EN50081-2:1993.
Safety:	Complies with EN61010-1:1993.
Supply Voltage:	90 - 264V, 50/60Hz (standard) 20 - 50V AC/DC (option)
Power Consumption:	4watts approximately
Front Panel Sealing:	To IP66 (Nema 4)

A.11 PHYSICAL

Dimensions:	Height - 48mm Width - 96mm Depth - 100mm
Mounting:	Panel-mount; press-fit fixing strap supplied. Panel cut-out - 45mm x 92mm
Terminals:	Screw type; combination head.
Weight:	0.21kg maximum.