

## Process controller 8800



**Operating manual**

**English**

**9499-040-70611**

Valid from: 8405



# 8800/8840 Configurator

More efficiency in engineering, more overview in operating:  
The projecting environment for the West controllers 8800/8840



**ATTENTION!**  
Mini Version and Updates on  
[www.iseinc.com](http://www.iseinc.com)

## Description of symbols:

-  General information
-  General warning
-  Attention: ESD sensitive devices

© West Instruments • Printed in Germany

All rights reserved. No part of this document may be reproduced or published in any form or by any means without prior written permission from the copyright owner.

A publication of West Instruments, The Hyde Business Park,  
Brighton BN2 4JU, England

## Contents

---

<b>1</b>	<b>Mounting</b> . . . . .	<b>6</b>
<b>2</b>	<b>Electrical connections</b> . . . . .	<b>7</b>
2.1	Connecting diagram . . . . .	7
2.2	Terminal connection. . . . .	8
<b>3</b>	<b>Operation</b> . . . . .	<b>12</b>
3.1	Front view . . . . .	12
3.2	Behaviour after power-on . . . . .	13
3.3	Operating level. . . . .	13
3.4	Error list / Maintenance manager . . . . .	14
3.5	Self-tuning . . . . .	17
3.5.1	Preparation for self-tuning . . . . .	17
3.5.2	Optimization after start-up or at the set-point. . . . .	18
3.5.3	Selecting the method (CONF/ENTER/ENTER) . . . . .	18
3.5.4	Self-tuning start . . . . .	22
3.5.5	<b>Self-tuning cancellation</b> . . . . .	<b>22</b>
3.5.6	<b>Acknowledgement procedures in case of unsuccessful self-tuning</b> .	<b>23</b>
3.5.7	<b>Examples for self-tuning attempts</b> . . . . .	<b>24</b>
3.6	Manual self-tuning . . . . .	25
3.7	Second PID parameter set . . . . .	26
3.8	Alarm handling. . . . .	27
3.9	Operating structure. . . . .	29
<b>4</b>	<b>Configuration level</b> . . . . .	<b>30</b>
4.1	Configuration survey . . . . .	30
4.2	Configuration parameters . . . . .	31
4.3	Set-point processing . . . . .	49
4.3.1	Set-point gradient / ramp . . . . .	49
4.4	Switching behavior . . . . .	50
4.4.1	Standard (CYCL = 0) . . . . .	50
4.4.2	Switching attitude linear (CYCL = 1) . . . . .	50
4.4.3	Switching attitude non-linear (CYCL = 2) . . . . .	51
4.4.4	Heating and cooling with constant period (CYCL = 3) . . . . .	52

4.5	Configuration examples . . . . .	53
4.5.1	On-Off controller / Signaller (inverse) . . . . .	53
4.5.2	2-point controller (inverse) . . . . .	54
4.5.3	3-point controller (relay & relay) . . . . .	55
4.5.4	3-point stepping controller (relay & relay) . . . . .	56
4.5.5	Continuous controller (inverse) . . . . .	57
4.5.6	$\Delta$ - Y - Off controller / 2-point controller with pre-contact . . . . .	58
4.5.7	8800 process controller with measured value output . . . . .	59
4.5.8	Continuous controller with integrated positioner (Enter / Func = 6) . . . . .	60
<b>5</b>	<b>Parameter setting level . . . . .</b>	<b>61</b>
5.1	Parameter survey . . . . .	61
5.2	Parameters . . . . .	62
5.3	Input scaling . . . . .	65
5.3.1	Input I nP.1 and I nP.3 . . . . .	65
5.3.2	Input I nP.2 . . . . .	66
<b>6</b>	<b>Calibration level . . . . .</b>	<b>67</b>
<b>7</b>	<b>Special functions . . . . .</b>	<b>70</b>
7.1	DAC <sup>®</sup> – motor actuator monitoring . . . . .	70
7.2	O <sub>2</sub> measurement . . . . .	72
7.2.1	Connection . . . . .	72
7.2.2	Configuration: . . . . .	73
7.3	Linearization . . . . .	74
7.4	8800 process controller as Modbus master . . . . .	75
<b>8</b>	<b>8800/8840 configurator . . . . .</b>	<b>76</b>
<b>9</b>	<b>Versions . . . . .</b>	<b>77</b>
<b>10</b>	<b>Technical data . . . . .</b>	<b>78</b>
<b>11</b>	<b>Safety hints . . . . .</b>	<b>81</b>
11.1	Resetting to factory setting. . . . .	82
<b>12</b>	<b>Notes . . . . .</b>	<b>83</b>

**1** Mounting

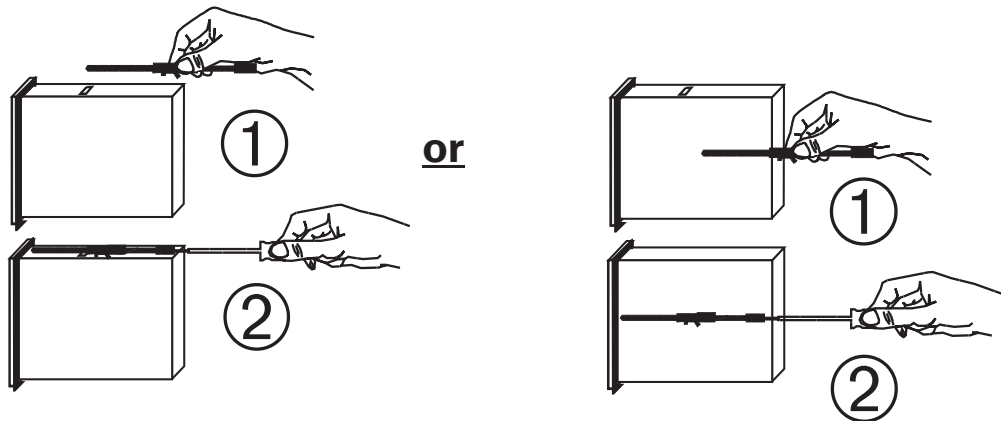
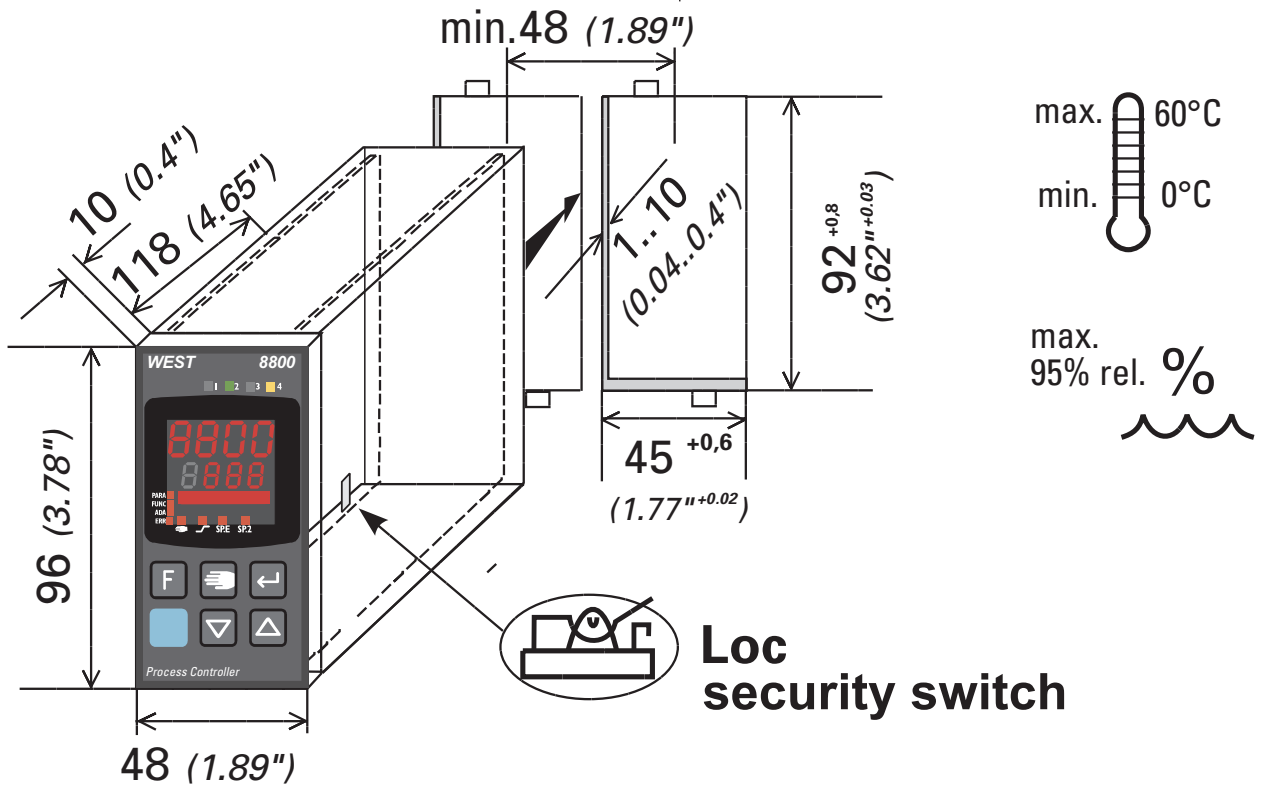

**Safety switch:**

For access to the safety switch, the controller must be withdrawn from the housing. Squeeze the top and bottom of the front bezel between thumb and forefinger and pull the controller firmly from the housing.

Loc	open	Access to the levels is as adjusted by means of 8800/8840 configurator (engineering tool) ②
	closed ①	all levels accessible without restriction

① Factory setting

② Default setting: display of all levels suppressed, password **PASS = OFF**



**Caution!** The unit contains ESD-sensitive components.

**2** Electrical connections

**2.1** Connecting diagram

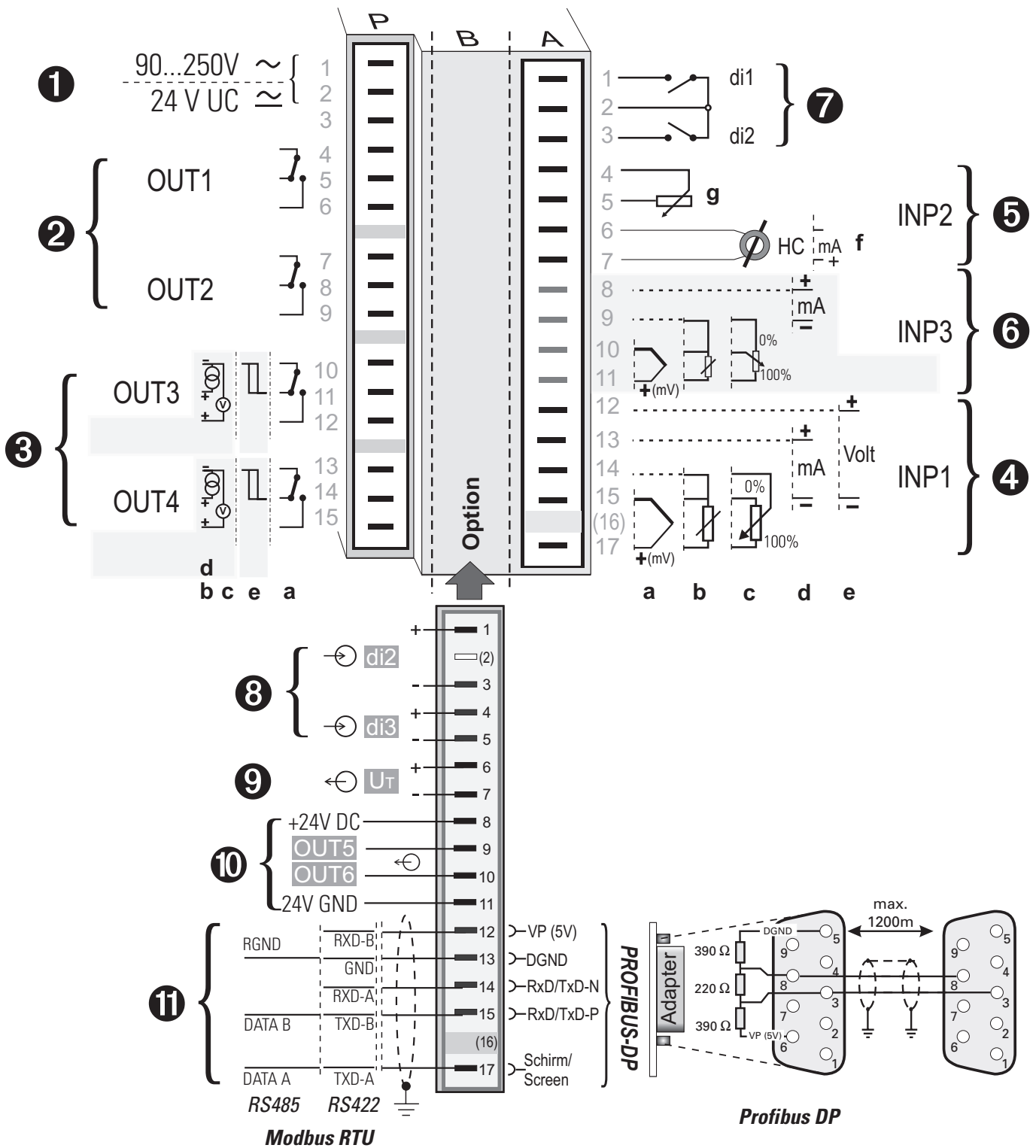

Dependent of order, the controller is fitted with :

- flat-pin terminals 1 x 6,3mm or 2 x 2,8mm to DIN 46 244 or
- screw terminals for 0,5 to 2,5mm<sup>2</sup>

**2.2 Terminal connection**

**Power supply connection ①**

See chapter 10 "Technical data"

**Connection of outputs OUT1/2 ②**

Relay outputs (250V/2A), potential-free changeover contact

**② OUT1/2 heating/cooling**

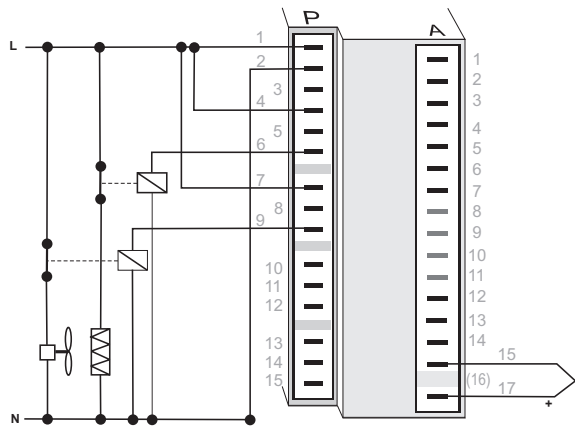

**Connection of outputs OUT3/4 ③**

- a relay (250V/2A), potential-free changeover contact universal output
- b current (0/4...20mA)
- c voltage (0/2...10V)
- d transmitter supply
- e logic (0..20mA / 0..12V)

**Connection of input INP1 ④**

Input mostly used for variable x1 (process value)

- a thermocouple
- b resistance thermometer (Pt100/ Pt1000/ KTY/ ...)
- c current (0/4...20mA)
- d voltage (0/2...10V)

**Connection of input INP2 ⑤**

- f heating current input (0..50mA AC) or input for ext. set-point (0/4...20mA)
- g potentiometer input for position feedback

**⑤ INP2 current transformer**

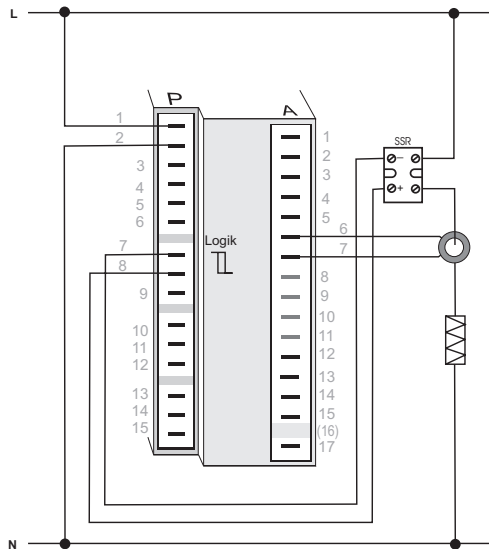

**Connection of input INP2 ⑤**

- a Heating current input (0...50mA AC) or input for ext. Set-point (0/4...20mA)
- b Potentiometer input for position feedback

**Connection of input INP3 ⑥**

As input INP1, but without voltage

**Connection of inputs di1, di2 ⑦**

Digital input, configurable as switch or push-button





3 OUT3 transmitter supply

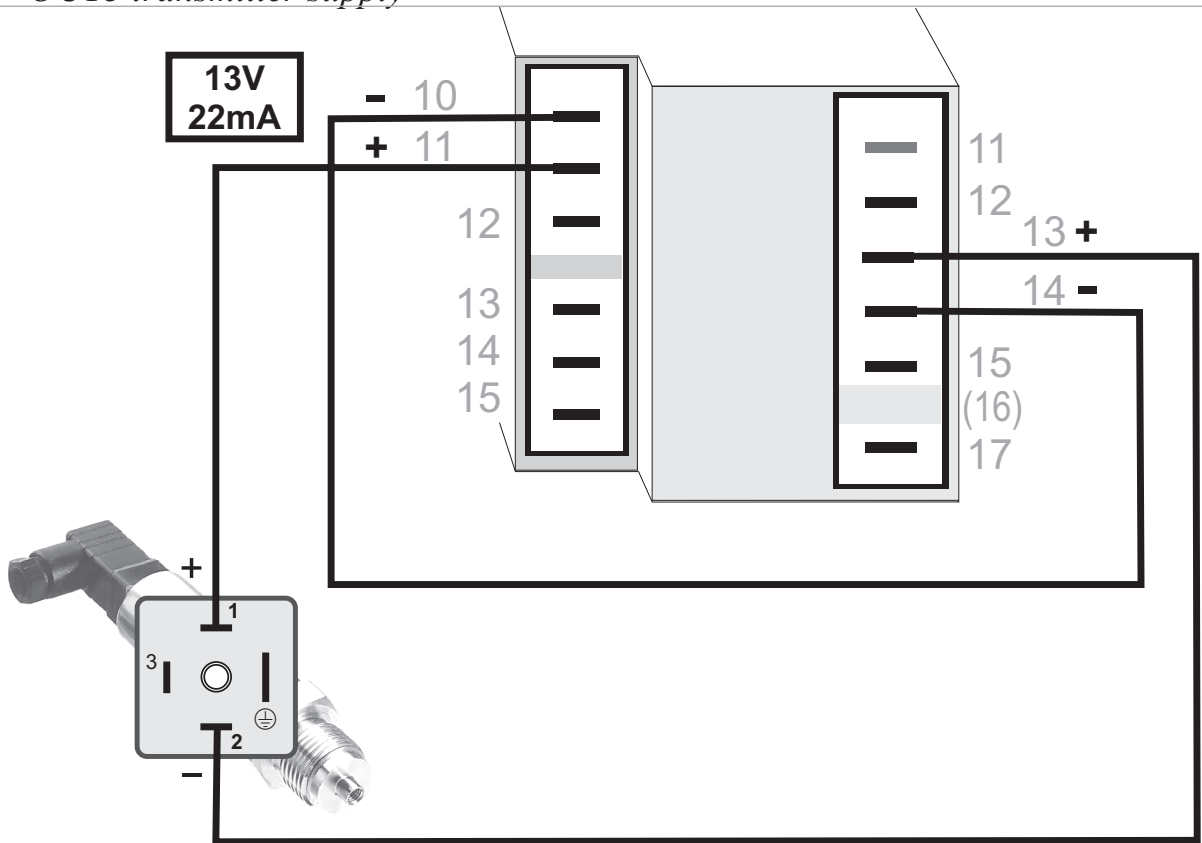

9 RS485 interface (with RS232-RS485 interface converter) \*

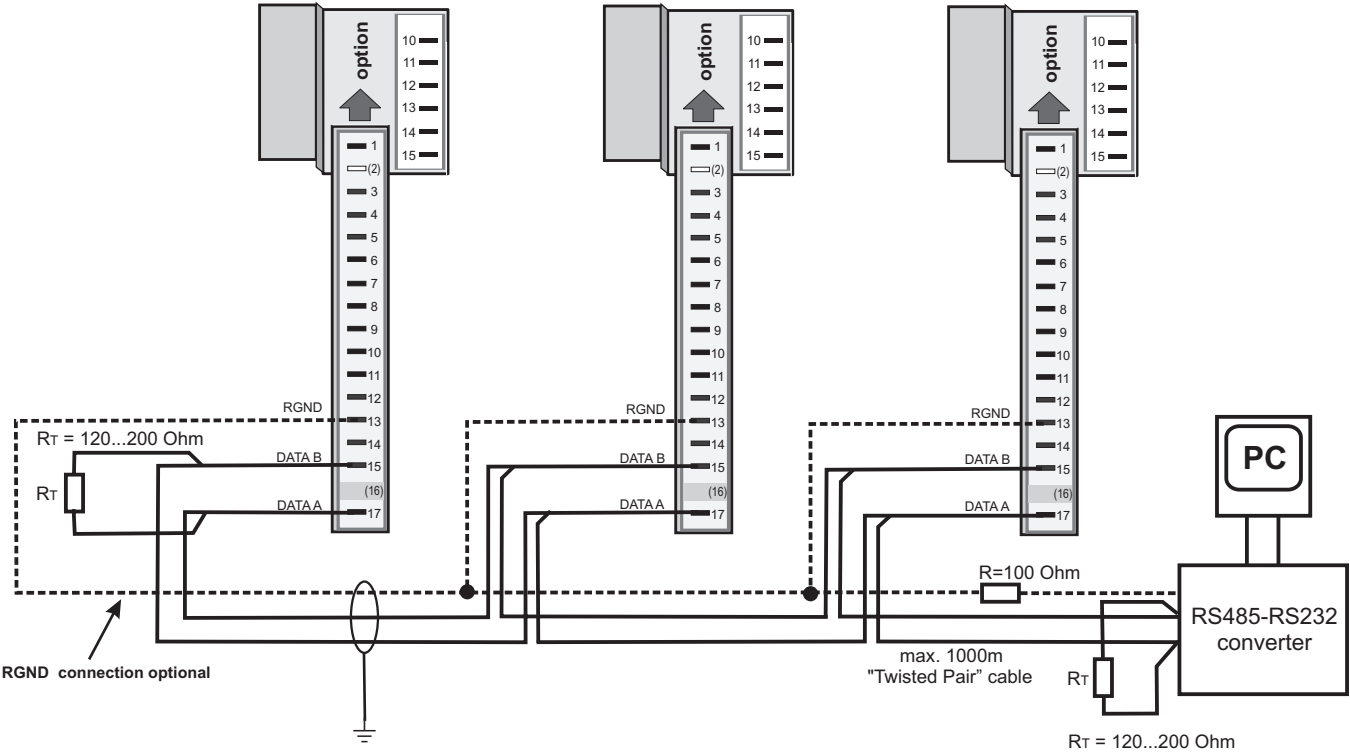

\* Interface description Modbus RTU in sepearte manual: see page 75.

## 3 OUT3 as logic output with solid-state relay (series and parallel connection)

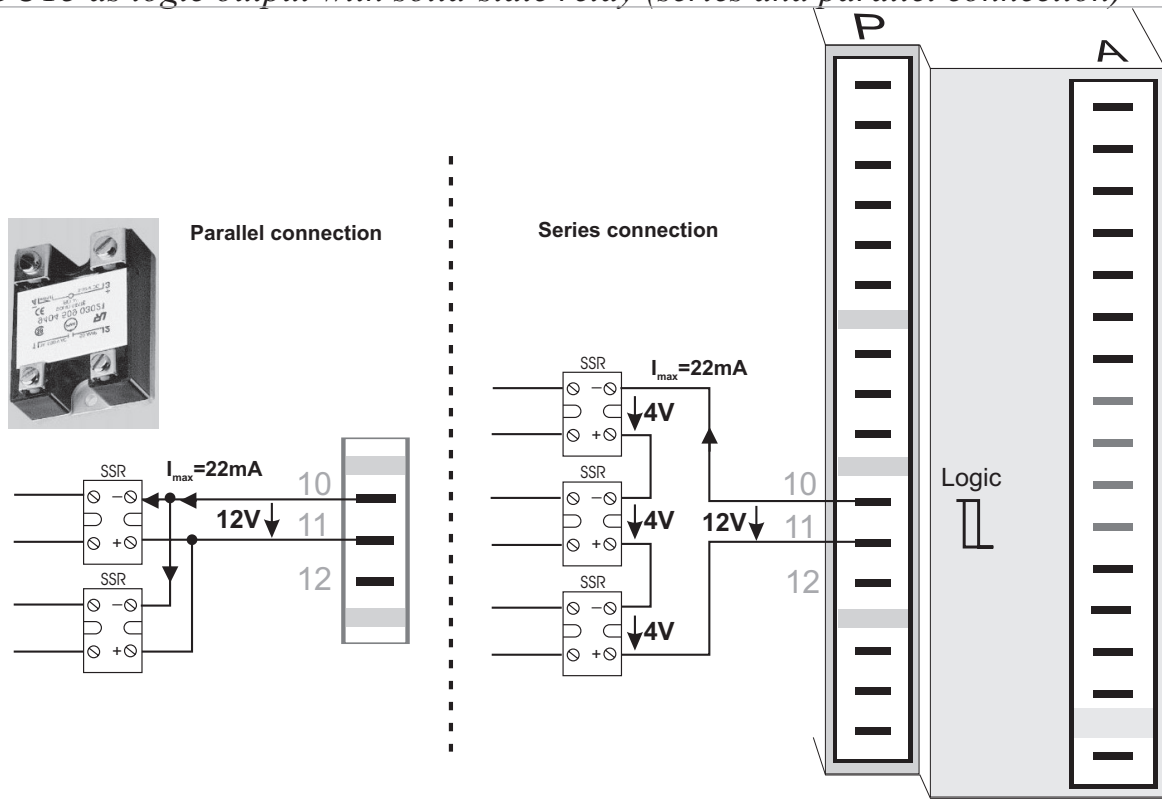

### 8800 process controller connecting example:

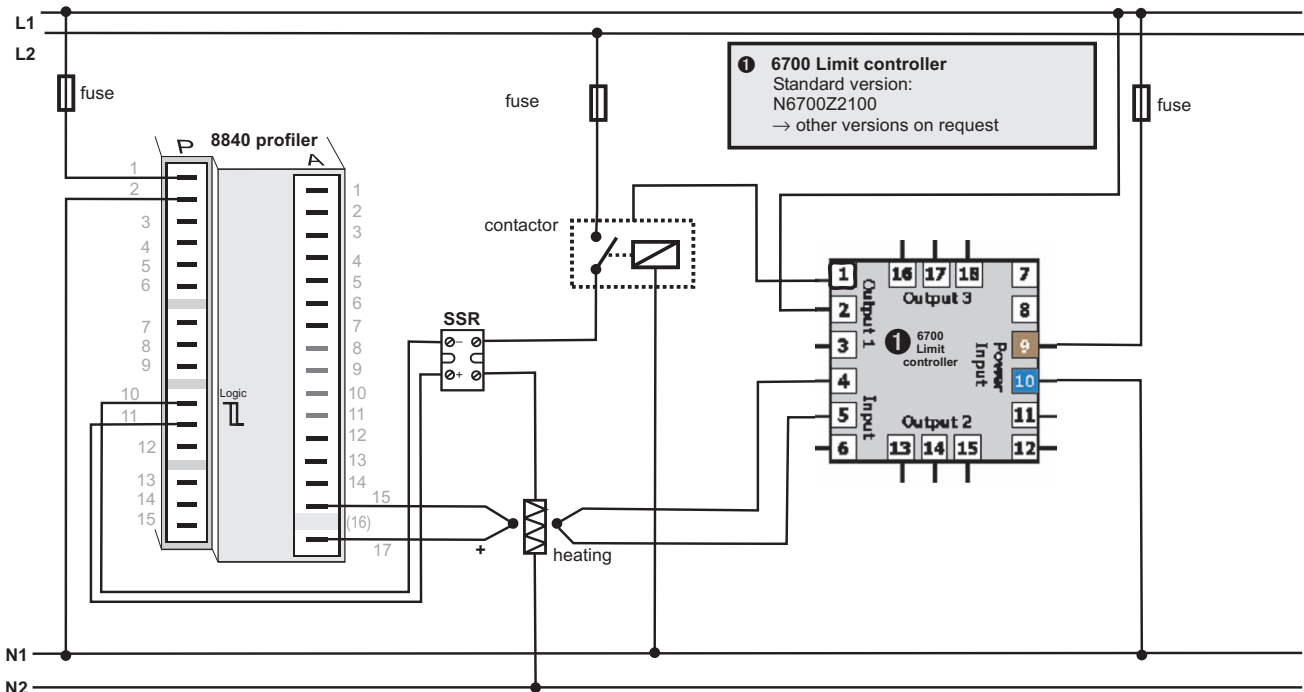

**CAUTION:** Using a Limit controller is recommendable in systems where overtemperature implies a fire hazard or other risks.

**3** Operation

**3.1** Front view

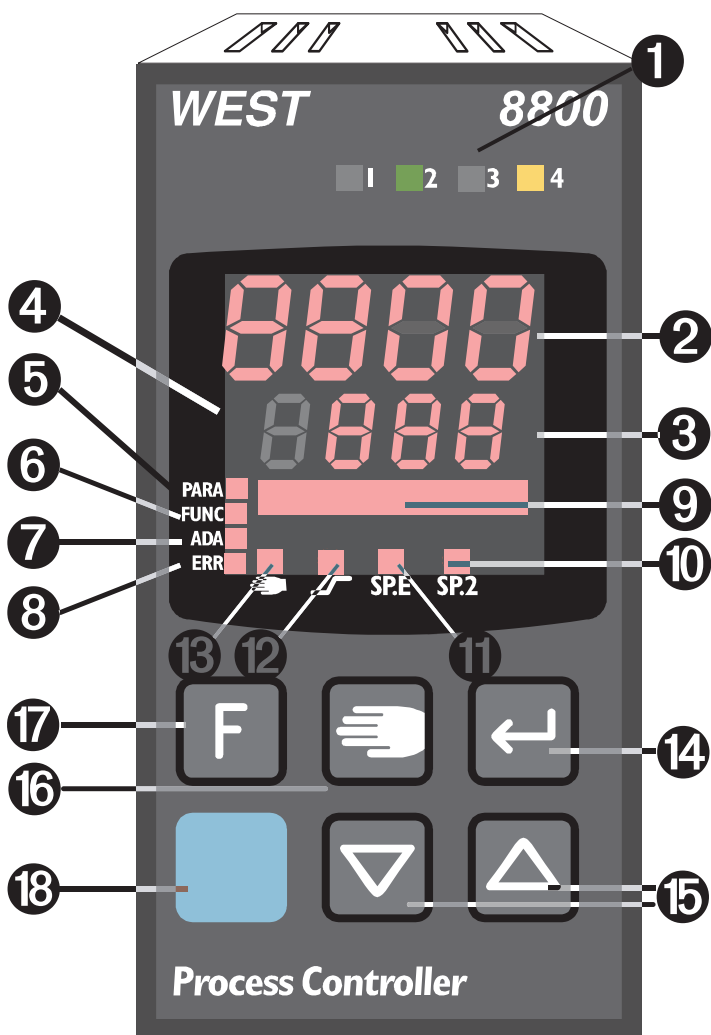

- ① Status of switching outputs Out. 1... 6
- ② Process value display
- ③ Set-point, controller output
- ④ Signals display on °C or °F
- ⑤ Signals CONF and PARA level
- ⑥ Signals active function key
- ⑦ Self-tuning active
- ⑧ Entry in error list
- ⑨ Bargraph or clear text display
- ⑩ S.P.1 is effective
- ⑪ S.P.2 is effective
- ⑫ Set-point gradient effective
- ⑬ Manual/automatic switch-over:  
Off: Automatic  
On: Manual (changing possible)  
Blinks: Manual (changing not possible  
(→ CONF / ENTER / PARA))
- ⑭ Enter key:  
calls up extended operating level / error list
- ⑮ Up/down keys:  
changing the set-point or the controller output value
- ⑯ Manual mode /spec. function  
(→ CONF / LOG1 )
- ⑰ Freely programmable function key
- ⑱ PC connection for 8800/8840 configurator (engineering tool)

**LED colours:**

LED 1, 2, 3, 4: yellow  
 Bargraph: red  
 other LEDs: red

**i** In the upper display line, the process value is always displayed. At parameter, configuration, calibration as well as extended operating level, the bottom display line changes cyclically between parameter name and parameter value.

### 3.2 Behaviour after power-on

After supply voltage switch-on, the unit starts with the **operating level**.

The unit is in the condition which was active before power-off.

If the 8800 process controller was in manual mode at supply voltage switch-off, the controller will re-start with the last output value in manual mode at power-on.

### 3.3 Operating level

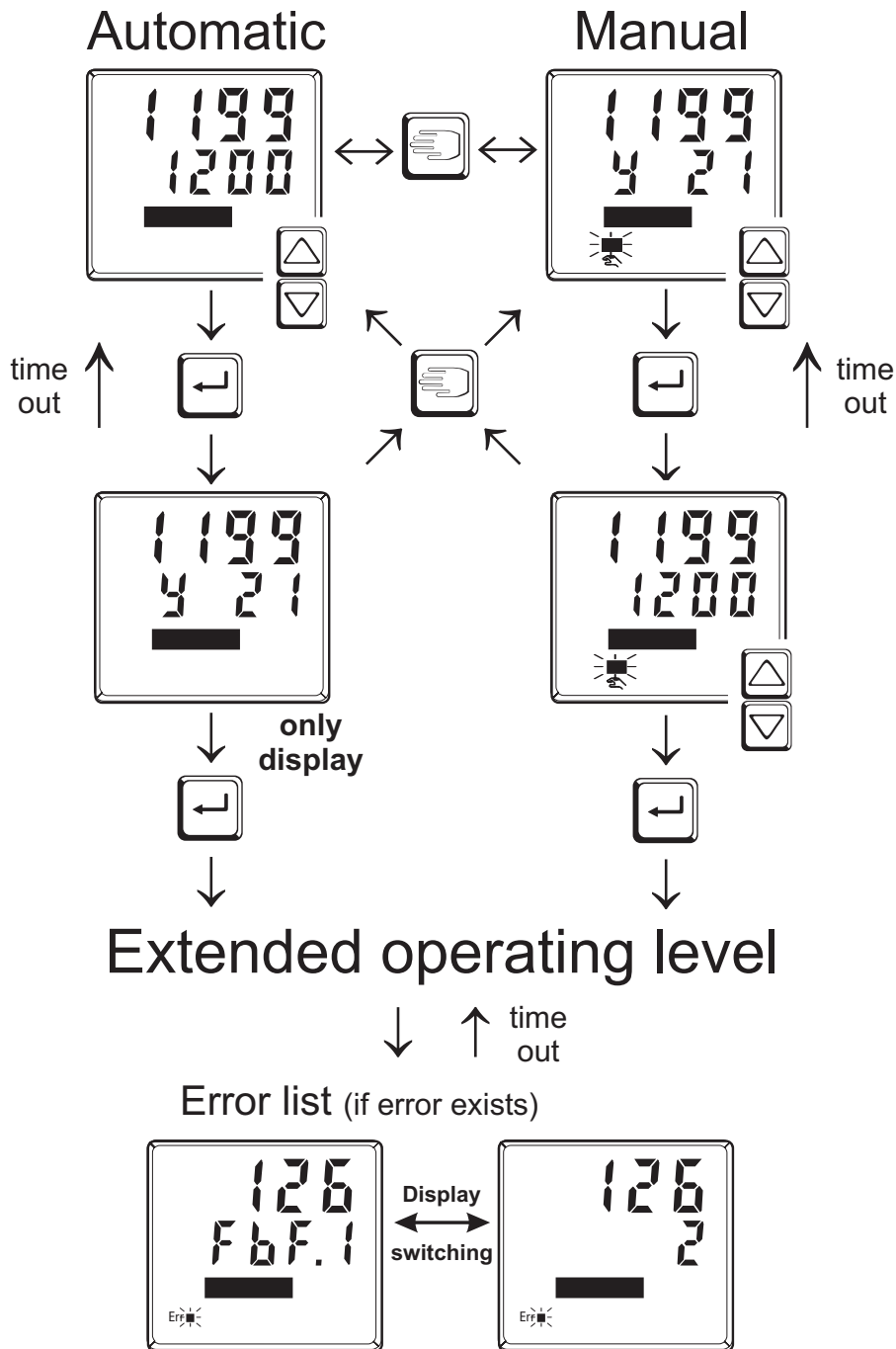

The content of the extended operating level is determined by means of 8800/8840 configurator (engineering tool). Parameters which are used frequently or the display of which is important can be copied to the extended operating level.



### 3.4 Error list / Maintenance manager

With one or several errors, the extended operating level always starts with the error list. Signalling an actual entry in the error list (alarm, error) is done by the Err LED in the display. To reach the error list press  twice.





Err LED status	Signification	Proceed as follows
blinks (status 2)	Alarm due to existing error	- Determine the error type in the error list - After error correction the unit changes to status 1
lit (status 1)	Error removed, alarm not acknowledged	- Acknowledge the alarm in the error list pressing key  or  - The alarm entry was deleted (status 0).
off (status 0)	No error, all alarm entries deleted	- Not visible except when acknowledging

#### Error list:

Name	Description	Reason	Possible remedial action
E.1	Internal error, cannot be removed	- E.g. defective EEPROM	- Contact West service - Return unit to our factory
E.2	Internal error, can be reset	- e.g. EMC trouble	- Keep measurement and power supply cables in separate runs - Ensure that interference suppression of contactors is provided
E.3	Configuration error, can be reset	- wrong configuration - missing configuration	- Check interaction of configuration / parameters
E.4	Hardware error	- Codenumber and hardware are not identical	- Contact West service - Elektronik-/Optioncard must be exchanged
FbF.1	Sensor break INP1	- Sensor defective - Faulty cabling	- Replace INP1 sensor - Check INP1 connection
ShE.1	Short circuit INP1	- Sensor defective - Faulty cabling	- Replace INP1 sensor - Check INP1 connection
POL.1	INP1 polarity error	- Faulty cabling	- Reverse INP1 polarity
FbF.2	Sensor break INP2	- Sensor defective - Faulty cabling	- Replace INP2 sensor - Check INP2 connection
ShE.2	Short circuit INP2	- Sensor defective - Faulty cabling	- Replace sensor INP2 - Check INP2 connection
POL.2	INP2 polarity	- Faulty cabling	- Reverse INP2 polarity
FbF.3	Sensor break INP3	- Sensor defective - Faulty cabling	- Replace INP3 sensor - Check INP3 connection
ShE.3	Short circuit INP3	- Sensor defective - Faulty cabling	- Replace sensor INP3 - Check INP3 connection
POL.3	INP3 polarity	- Faulty cabling	- Reverse INP3 polarity

Name	Description	Reason	Possible remedial action
HCA	Heating current alarm (HCA)	<ul style="list-style-type: none"> <li>- Heating current circuit interrupted, <math>I &lt; HCA</math> or <math>I &gt; HCA</math> (dependent of configuration)</li> <li>- Heater band defective</li> </ul>	<ul style="list-style-type: none"> <li>- Check heating current circuit</li> <li>- If necessary, replace heater band</li> </ul>
SSR	Heating current short circuit (SSR)	<ul style="list-style-type: none"> <li>- Current flow in heating circuit with controller off</li> <li>- SSR defective</li> </ul>	<ul style="list-style-type: none"> <li>- Check heating current circuit</li> <li>- If necessary, replace solid-state relay</li> </ul>
LOOP	Control loop alarm (LOOP)	<ul style="list-style-type: none"> <li>- Input signal defective or not connected correctly</li> <li>- Output not connected correctly</li> </ul>	<ul style="list-style-type: none"> <li>- Check heating or cooling circuit</li> <li>- Check sensor and replace it, if necessary</li> <li>- Check controller and switching device</li> </ul>
ADAH	Self-tuning heating alarm (ADAH)	<ul style="list-style-type: none"> <li>- See Self-tuning heating error status</li> </ul>	<ul style="list-style-type: none"> <li>- see Self-tuning heating error status</li> </ul>
ADAC	Self-tuning heating alarm cooling (ADAC)	<ul style="list-style-type: none"> <li>- See Self-tuning cooling error status</li> </ul>	<ul style="list-style-type: none"> <li>- see Self-tuning cooling error status</li> </ul>
L.lim.1	stored limit alarm 1	<ul style="list-style-type: none"> <li>- adjusted limit value 1 exceeded</li> </ul>	<ul style="list-style-type: none"> <li>- check process</li> </ul>
L.lim.2	stored limit alarm 2	<ul style="list-style-type: none"> <li>- adjusted limit value 2 exceeded</li> </ul>	<ul style="list-style-type: none"> <li>- check process</li> </ul>
L.lim.3	stored limit alarm 3	<ul style="list-style-type: none"> <li>- adjusted limit value 3 exceeded</li> </ul>	<ul style="list-style-type: none"> <li>- check process</li> </ul>
Inf.1	time limit value message	<ul style="list-style-type: none"> <li>- adjusted number of operating hours reached</li> </ul>	<ul style="list-style-type: none"> <li>- application-specific</li> </ul>
Inf.2	duty cycle message (digital outputs)	<ul style="list-style-type: none"> <li>- adjusted number of duty cycles reached</li> </ul>	<ul style="list-style-type: none"> <li>- application-specific</li> </ul>
ES	Internal error in DP module	<ul style="list-style-type: none"> <li>- self-test error</li> <li>- internal communication interrupted</li> </ul>	<ul style="list-style-type: none"> <li>- Switch on the instrument again</li> <li>- Contact West service</li> </ul>
DP.1	No access by bus master	<ul style="list-style-type: none"> <li>- bus error</li> <li>- connector problem</li> <li>- no bus connection</li> </ul>	<ul style="list-style-type: none"> <li>- Check cable</li> <li>- Check connector</li> <li>- Check connections</li> </ul>
DP.2	Faulty configuration	<ul style="list-style-type: none"> <li>- Faulty DP configuration telegram</li> </ul>	<ul style="list-style-type: none"> <li>- Check DP configuration telegram in master</li> </ul>
DP.3	Inadmissible parameter setting telegram sent	<ul style="list-style-type: none"> <li>- Faulty DP parameter setting telegram</li> </ul>	<ul style="list-style-type: none"> <li>- Check DP parameter setting telegram in master</li> </ul>
DP.4	No data communication	<ul style="list-style-type: none"> <li>- Bus error</li> <li>- Address error</li> <li>- Master stopped</li> </ul>	<ul style="list-style-type: none"> <li>- Check cable connection</li> <li>- Check address</li> <li>- Check master setting</li> </ul>

-  Saved alarms (Err-LED is lit) can be acknowledged and deleted with the digital input di1/2/3, the **[F]**-key or the **[E]**-key.  
Configuration, see page 37: **CONF / LOG1 / Err.r**
-  If an alarm is still valid that means the cause of the alarm is not removed so far (Err-LED blinks), then other saved alarms can not be acknowledged and deleted.

**Self-tuning heating (AdRH) and cooling (AdRL) error status:**

Error status	Description	Behaviour
0	No error	
3	Faulty control action	Re-configure controller (inverse ↔ direct)
4	No response of process variable	The control loop is perhaps not closed: check sensor, connections and process
5	Low reversal point	Increase (AdRH) max. output limiting <b>YH</b> , or decrease (AdRL) min. output limiting <b>YL</b> o
6	Danger of exceeded set-point (parameter determined)	If necessary, increase (inverse) or reduce (direct) set-point
7	Output step change too small ( $\Delta y > 5\%$ )	Increase (AdRH) max. output limiting <b>YH</b> , or reduce (AdRL) min. output limiting <b>YL</b> o
8	Set-point reserve too small	Acknowledgment of this error message leads to switch-over to automatic mode. If self-tuning shall be continued, increase set-point (invers), reduce set-point (direct) or decrease set-point range (→ <b>PARA / SETP / SPLO</b> and <b>SPH</b> , )
9	Impulse tuning failed	The control loop is perhaps not closed: check sensor, connections and process

**DAC function (dRL) error status:**

Error status	Description	Behaviour
0	No error	
3	Output is blocked	Check the drive for blockage
4	Wrong method of operation	Wrong phasing, defect motor capacitor
5	Fail at Yp measurement	Check the connection to the Yp input
6	Calibration error	Manual calibration necessary

### 3.5 Self-tuning

For determination of optimum process parameters, self-tuning is possible. After starting by the operator, the controller makes an adaptation attempt, whereby the process characteristics are used to calculate the parameters for fast line-out to the set-point without overshoot.

**The following parameters are optimized when self-tuning:**

**Parameter set 1:**

- Pb1** - Proportional band 1 (heating) in engineering units [e.g. °C]
- t i1** - Integral time 1 (heating) in [s]  
→ only, unless set to **OFF**
- t d1** - Derivative time 1 (heating) in [s]  
→ only, unless set to **OFF**
- t t1** - Minimum cycle time 1 (heating) in [s]  
→ only, unless **Adt0** was set to “no self-tuning” during configuration by means of 8800/8840 configurator®.
- Pb2** - Proportional band 2 (cooling) in engineering units [e.g. °C]
- t i2** - Integral time 2 (cooling) in [s]  
→ only, unless set to **OFF**
- t d2** - Derivative time 2 (cooling) in [s]  
→ only, unless set to **OFF**
- t t2** - Minimum cycle time 2 (cooling) in [s]  
→ only, unless **Adt0** was set to “no self-tuning” during configuration by means of 8800/8840 configurator®.

**Parameter set 2:** analogous to parameter set 1 (see page25)

#### 3.5.1 Preparation for self-tuning

- Adjust the controller measuring range as control range limits. Set values **r nL** and **r nH** to the limits of subsequent control.  
(Configuration→Controller→lower and upper control range limits)  
**CONF** → **Enter** → **r nL** and **r nH**
- Determine which parameter set shall be optimized.  
-The instantaneously effective parameter set is optimized.  
→ Activate the relevant parameter set (1 or 2).
- Determine which parameter set shall be optimized (see tables above).
- Select the self-tuning method  
see chapter 3.5.3  
-Step attempt after start-up  
-Pulse attempt after start-up  
-Optimization at the set-point



### 3.5.2 Optimization after start-up or at the set-point

The two methods are optimization after start-up and at the set-point. As control parameters are always optimal only for a limited process range, various methods can be selected dependent of requirements. If the process behaviour is very different after start-up and directly at the set-point, parameter sets 1 and 2 can be optimized using different methods. Switch-over between parameter sets dependent of process status is possible (see page 25).

#### Optimization after start-up: (see page 25)

Optimization after start-up requires a certain separation between process value and set-point. This separation enables the controller to determine the control parameters by evaluation of the process when lining out to the set-point. This method optimizes the control loop from the start conditions to the set-point, whereby a wide control range is covered.

We recommend selecting optimization method “**Step attempt after start-up**” with  $t_{\text{start}} = 0$  first. Unless this attempt is completed successfully, we recommend a “**Pulse attempt after start-up**”.

#### Optimization at the set-point: (see page 18)

For optimizing at the set-point, the controller outputs a disturbance variable to the process. This is done by changing the output variable shortly. The process value changed by this pulse is evaluated. The detected process parameters are converted into control parameters and saved in the controller.

This procedure optimizes the control loop directly at the set-point. The advantage is in the small control deviation during optimization.

### 3.5.3 Selecting the method (CONF / ENTR / t\_start)

#### Selection criteria for the optimization method:

	Step attempt after start-up	Pulse attempt after start-up	Optimization at the set-point
$t_{\text{start}} = 0$	sufficient set-point reserve is provided		sufficient set-point reserve is <b>not</b> provided
$t_{\text{start}} = 1$		sufficient set-point reserve is provided	sufficient set-point reserve is <b>not</b> provided
$t_{\text{start}} = 2$	always step attempt after start-up		

#### Sufficient set-point reserve:

inverse controller: (with process value < set-point - (10% of  $r_{\text{nomH}} - r_{\text{nomL}}$ )

direct controller: (with process value > set-point + (10% of  $r_{\text{nomH}} - r_{\text{nomL}}$ )

#### Step attempt after start-up

Condition:  $t_{\text{start}} = 0$  and sufficient set-point reserve provided **or**  
 $t_{\text{start}} = 2$

The controller outputs 0% correcting variable or  $\Delta u$  and waits, until the process is at rest (see start-conditions on page 16).

Subsequently, a correcting variable step change to 100% is output.

The controller attempts to calculate the optimum control parameters from the process response. If this is done successfully, the optimized parameters are taken over and used for line-out to the set-point.

With a *3-point controller*, this is followed by “cooling”.

After completing the 1st step as described, a correcting variable of -100% (100% cooling energy) is output from the set-point. After successful determination of the “cooling parameters”, line-out to the set-point is using the optimized parameters.

### **Pulse attempt after start-up**

Condition:  $\text{RUNE} = 1$  and sufficient set-point reserve provided.

The controller outputs 0% correcting variable or  $\text{UL}$  and waits, until the process is at rest (see start conditions page 16)

Subsequently, a short pulse of 100% is output ( $Y=100\%$ ) and reset.

The controller attempts to determine the optimum control parameters from the process response. If this is completed successfully, these optimized parameters are taken over and used for line-out to the set-point.

With a *3-point controller*, this is followed by “cooling”.

After completing the 1st step as described and line-out to the set-point, correcting variable "heating" remains unchanged and a cooling pulse (100% cooling energy) is output **additionally**. After successful determination of the “cooling parameters”, the optimized parameters are used for line-out to the set-point.

### **Optimization at the set-point**

Conditions:

- A sufficient set-point reserve is **not** provided at self-tuning start (see page 17).
- $\text{RUNE}$  is 0 or 1
- With  $\text{SETE} = 1$  configured and detection of a process value oscillation by more than  $\pm 0,5\%$  of  $(\text{r.n.H} - \text{r.n.L})$  by the controller, the control parameters are preset for process stabilization and the controller realizes an *optimization at the set-point* (see figure “Optimization at the set-point”).
- when the step attempt after power-on has failed
- with active gradient function ( $\text{PARA/SETP/r.SP} \neq \text{OFF}$ ), the set-point gradient is started from the process value and there isn't a sufficient set-point reserve.

**Optimization-at-the-set-point procedure:**

The controller uses its instantaneous parameters for control to the set-point. In lined out condition, the controller makes a pulse attempt. This pulse reduces the correcting variable by max. 20% ❶, to generate a slight process value undershoot. The changing process is analyzed and the parameters thus calculated are recorded in the controller. The optimized parameters are used for line-out to the set-point.

*Optimization at the set-point*

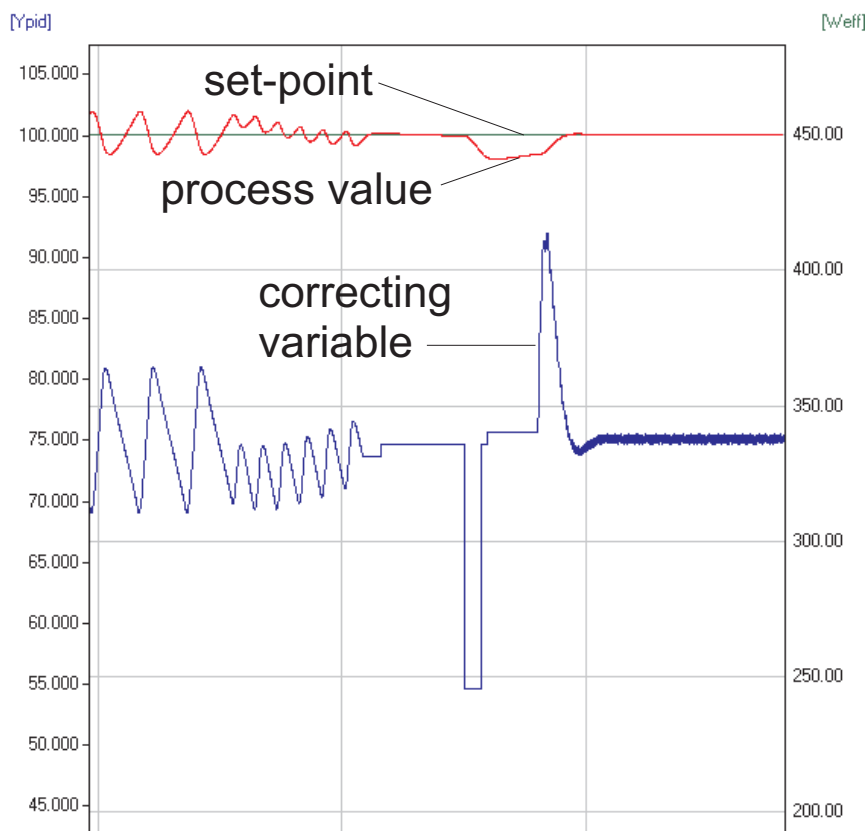

With a 3-point controller, optimization for the “heating“ or “cooling” parameters occurs dependent of the instantaneous condition. These two optimizations must be started separately.

❶ If the correcting variable is too low for reduction in lined out condition it is increased by max. 20%.

## Optimization at the set-point for 3-point stepping controller

With 3-point stepping controllers, the pulse attempt can be made with or without position feedback. Unless feedback is provided, the controller calculates the motor actuator position internally by varying an integrator with the adjusted actuator travel time. For this reason, precise entry of the actuator travel time ( $t_t$ ), as time between stops is highly important. Due to position simulation, the controller knows whether an increased or reduced pulse must be output. After supply voltage switch-on, position simulation is at 50%. When the motor actuator was varied by the adjusted travel time in one go, internal calculation occurs, i.e. the position corresponds to the simulation:

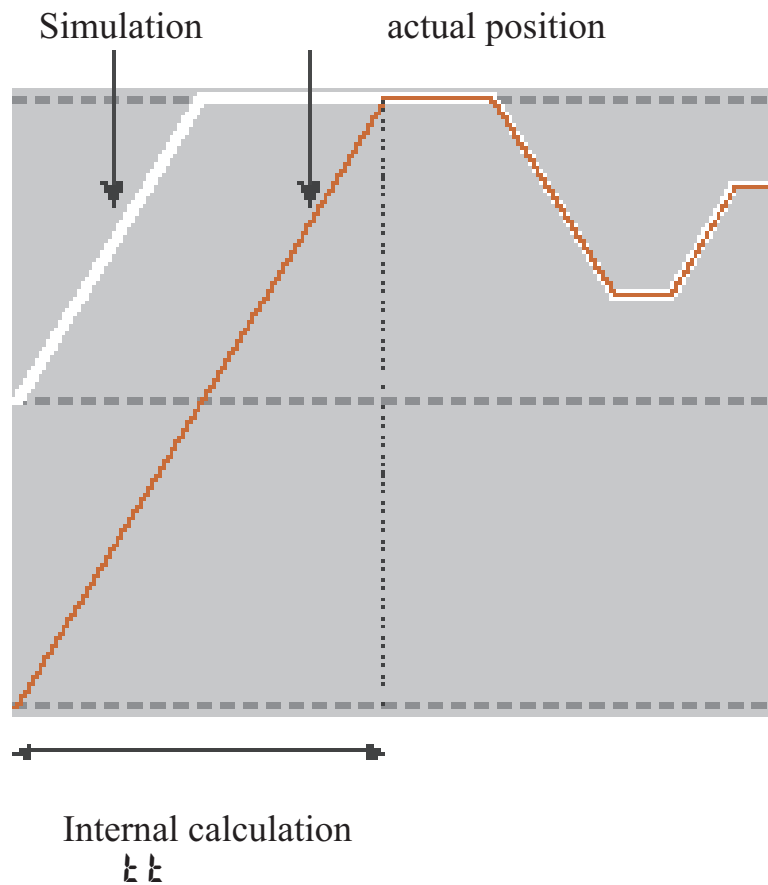

Internal calculation always occurs, when the actuator was varied by travel time  $t_t$  *in one go*, independent of manual or automatic mode. When interrupting the variation, internal calculation is cancelled. Unless internal calculation occurred already after self-tuning start, it will occur automatically by closing the actuator once.





Unless the positioning limits were reached within 10 hours, a significant deviation between simulation and actual position may have occurred. In this case, the controller would realize minor internal calculation, i.e. the actuator would be closed by 20 %, and re-opened by 20 % subsequently. As a result, the controller knows that there is a 20% reserve for the attempt.

### 3.5.4 Self-tuning start

**Start condition:**

- For process evaluation, a stable condition is required. Therefore, the controller waits until the process has reached a stable condition after self-tuning start.  
The rest condition is considered being reached, when the process value oscillation is smaller than  $\pm 0,5\%$  of  $(r_{nGH} - r_{nGL})$ .
- For self-tuning start after start-up, a 10% difference from  $(SPLO \dots SPHI)$  is required.

**i** Self-tuning start can be blocked via 8800/8840 configurator<sup>®</sup> (engineering tool) (PLoc).



- Start = 0** Only manual start by pressing keys  and  simultaneously or via interface is possible.
- Start = 1** Manual start by press keys  and  simultaneously via interface and automatic start after power-on and detection of process oscillations.

Ada LED status	Signification
blinks	Waiting, until process calms down
lit	Self-tuning is running
off	Self-tuning not active or ended



### 3.5.5 Self-tuning cancellation





**By the operator:**

Self-tuning can always be cancelled by the operator. For this, press  and  key simultaneously. With controller switch-over to manual mode after self-tuning start, self-tuning is cancelled. When self-tuning is cancelled, the controller will continue operating using the old parameter values.

**By the controller:**

If the Err LED starts blinking whilst self-tuning is running, successful self-tuning is prevented due to the control conditions. In this case, self-tuning was cancelled by the controller. The controller continues operating with the old parameters in automatic mode. In manual mode it continues with the old controller output value.

### 3.5.6 Acknowledgement procedures in case of unsuccessful self-tuning

1. Press keys  and  simultaneously:  
The controller continues controlling using the old parameters in automatic mode. The Err LED continues blinking, until the self-tuning error was acknowledged in the error list.
2. Press key  (if configured):  
The controller goes to manual mode. The Err LED continues blinking, until the self-tuning error was acknowledged in the error list.
3. Press key  :  
Display of error list at extended operating level. After acknowledgement of the error message, the controller continues control in automatic mode using the old parameters.

### **Cancellation causes:**

→ page 15: "Error status self-tuning heating ( *AdRH* ) and cooling ( *AdRL* )"

### 3.5.7 Examples for self-tuning attempts (controller inverse, heating or heating/cooling)

**Start: heating power switched on**

Heating power Y is switched off (1). When the change of process value X was constant during one minute (2), the power is switched on (3). At the reversal point, the self-tuning attempt is finished and the new parameter are used for controlling to set-point W.

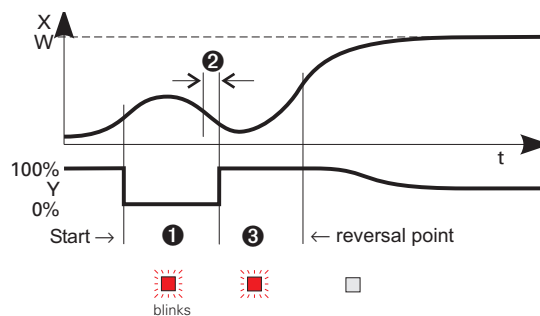

**Start: heating power switched off**

The controller waits 1,5 minutes (1). Heating power Y is switched on (2). At the reversal point, the self-tuning attempt is finished and control to the set-point is using the new parameters.

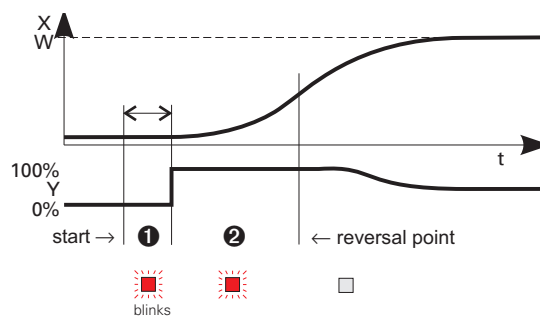

**Self-tuning at the set-point** ⚠

The process is controlled to the set-point. With the control deviation constant during a defined time (1) (i.e. constant separation of process value and set-point), the controller outputs a reduced correcting variable pulse (max. 20%) (2). After determination of the control parameters using the process characteristic (3), control is started using the new parameters (4).

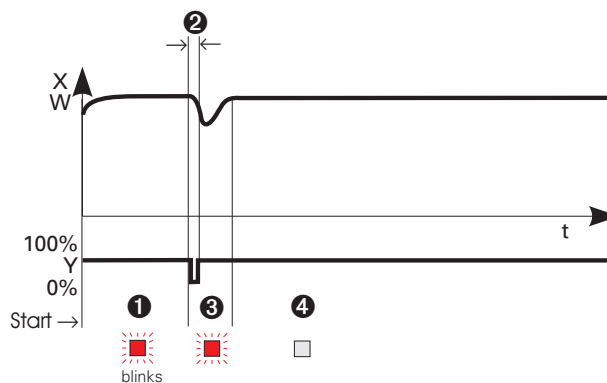

**Three-point controller** ⚠

The parameter for heating and cooling are determined in two attempts. The heating power is switched on (1). Heating parameters  $Pb1$ ,  $t_{i1}$ ,  $t_{d1}$  and  $t_{r1}$  are determined at the reversal point. Control to the set-point occurs (2). With constant control deviation, the controller provides a cooling correcting variable pulse (3). After determining its cooling parameters  $Pb2$ ,  $t_{i2}$ ,  $t_{d2}$  and  $t_{r2}$  (4) from the process characteristics, control operation is started using the new parameters (5).

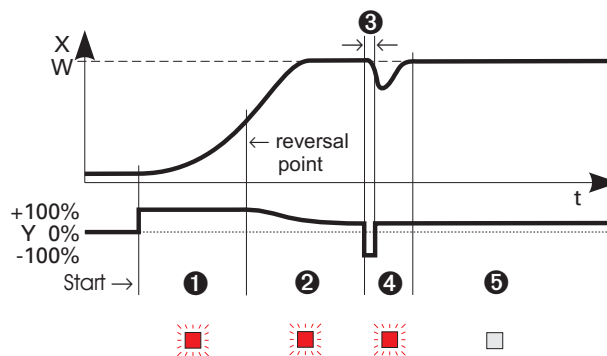

During phase 3, heating and cooling are done simultaneously!

**3.6 Manual self-tuning**

The optimization aid can be used with units on which the control parameters shall be set without self-tuning.

For this, the response of process variable  $x$  after a step change of correcting variable  $y$  can be used. Frequently, plotting the complete response curve (0 to 100%) is not possible, because the process must be kept within defined limits.

Values  $T_g$  and  $x_{max}$  (step change from 0 to 100 %) or  $\Delta t$  and  $\Delta x$  (partial step response) can be used to determine the maximum rate of increase  $v_{max}$ .

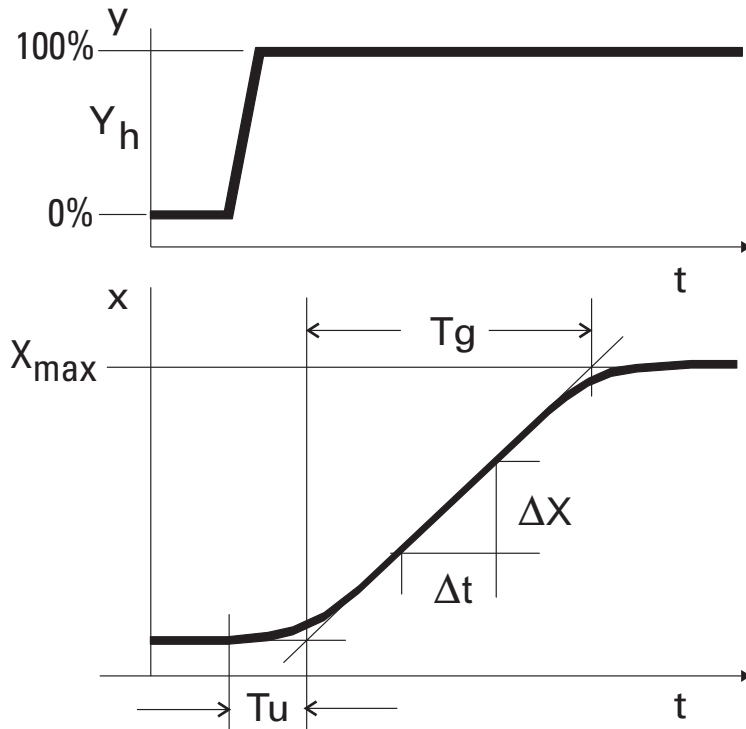

- $y$  = correcting variable
- $Y_h$  = control range
- $T_u$  = delay time (s)
- $T_g$  = recovery time (s)
- $X_{max}$  = maximum process value

$$V_{max} = \frac{X_{max}}{T_g} = \frac{\Delta x}{\Delta t} \triangleq \text{max. rate of increase of process value}$$

The control parameters can be determined from the values calculated for delay time  $T_u$ , maximum rate of increase  $v_{max}$ , control range  $X_h$  and characteristic  $K$  according to the **formulas** given below. Increase  $Pb1$ , if line-out to the set-point oscillates.



*Parameter adjustment effects*

Parameter	Control	Line-out of disturbances	Start-up behaviour
$Pb1$ high	increased damping	slower line-out	slower reduction of duty cycle
lower	reduced damping	faster line-out	faster reduction of duty cycle
$td1$ high	reduced damping	faster response to disturbances	faster reduction of duty cycle
lower	increased damping	slower response to disturbances	slower reduction of duty cycle

*Formulas*

$$K = V_{max} * Tu$$

With 2-point and 3-point controllers, the cycle time must be adjusted to  $t1/t2 \leq 0,25 * Tu$

controller behavior	$Pb1$ [phy. units]	$td1$ [s]	$t1$ [s]
PID	$1,7 * K$	$2 * Tu$	$2 * Tu$
PD	$0,5 * K$	$Tu$	OFF
PI	$2,6 * K$	OFF	$6 * Tu$
P	$K$	OFF	OFF
3-point-stepping	$1,7 * K$	$Tu$	$2 * Tu$

**3.7 Second PID parameter set**

The process characteristic is frequently affected by various factors such as process value, correcting variable and material differences.

To comply with these requirements, the 8800 process controller can be switched over between two parameter sets.

Parameter sets  $PAR1$  and  $PAR2$  are provided for heating and cooling.

Dependent of configuration ( $CONF/LOG/Pid2$ ), switch-over to the second parameter set ( $CONF/LOG/Pid2$ ) is via one of digital inputs di1, di2, di3, key  $\boxed{F}$  or interface (OPTION).



Self-tuning is always done using the active parameter set, i.e. the second parameter set must be active for optimizing.

### 3.8 Alarm handling

Max. three alarms can be configured and assigned to the individual outputs. Generally, outputs `Out.1`... `Out.6` can be used each for alarm signalling. If more than one signal is linked to one output the signals are OR linked. Each of the 3 limit values `L.1`... `L.3` has 2 trigger points `H.x` (Max) and `L.x` (Min), which can be switched off individually (parameter = "OFF"). Switching difference `HYS.x` and delay `DEL.x` of each limit value is adjustable.

① Operating principle **absolute alarm**  
L.1 = OFF

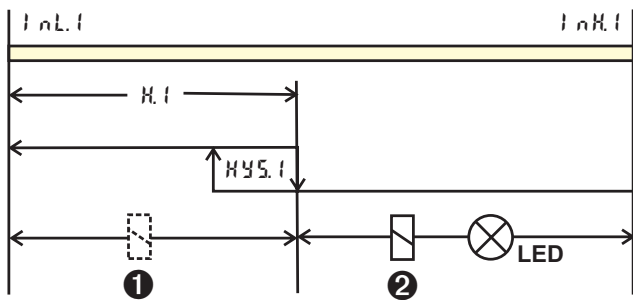

② Operating principle **relative alarm**  
L.1 = OFF

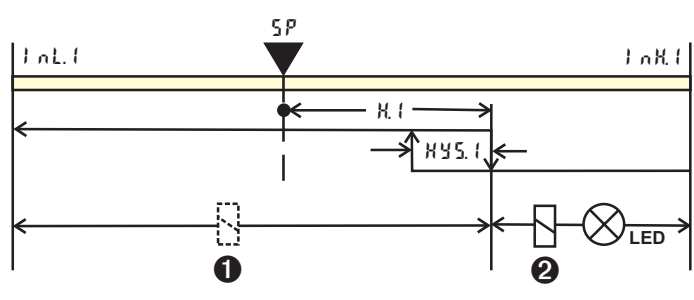

H.1 = OFF

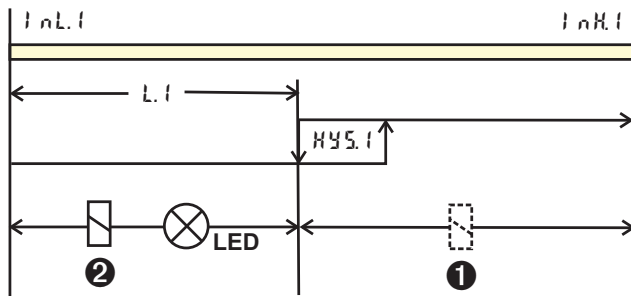

H.1 = OFF

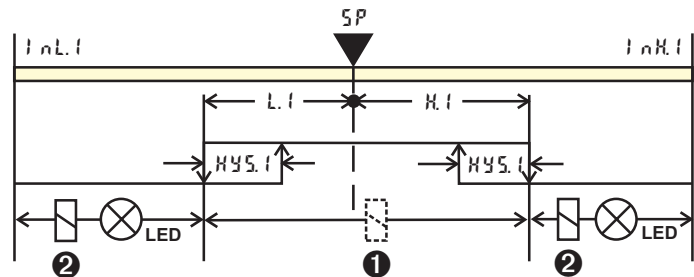
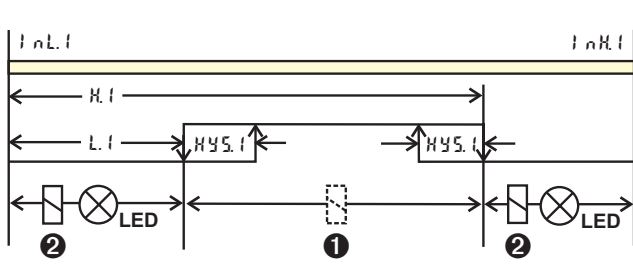
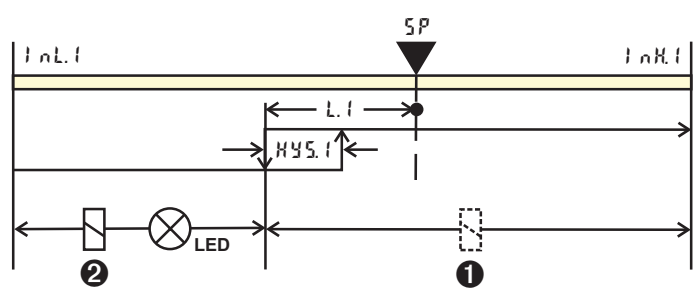

①: normally closed ( `CONF/Out.x/OrAct = 1` )

②: normally open ( `CONF/Out.x/OrAct = 0` )

**i** The variable to be monitored can be selected separately for each alarm via configuration

The following variables can be monitored:

- process value
- control deviation  $x_w$  (process value - set-point)
- control deviation  $x_w$  + suppression after start-up or set-point change  
 After switching on or set-point changing, the alarm output is suppressed, until the process value is within the limits for the first time. At the latest after expiration of time  $10 \cdot t_i$ , the alarm is activated. ( $t_i$  = integral time 1; parameter  $\rightarrow$   $L_{int}$ )  
 If  $t_i$  is switched off ( $t_i = OFF$ ), this is interpreted as  $\infty$ , i.e. the alarm is not activated, before the process value was within the limits once.
- Measured value INP1
- Measured value INP2
- Measured value INP3
- effective set-point  $W_{eff}$
- correcting variable  $y$  (controller output)
- Deviation from SP internal
- Process value -  $x_2$

**i** If measured value monitoring + alarm status storage is chosen ( $L_{on} / L_{off} / F_{on} = 2/4$ ), the alarm relay remains switched on until the alarm is reset in the error list ( $L_{off} / F_{off} = 1$ ).

### 3.9 Operating structure

After supply voltage switch-on, the controller starts with the **operating levels**. The controller status is as before power off.

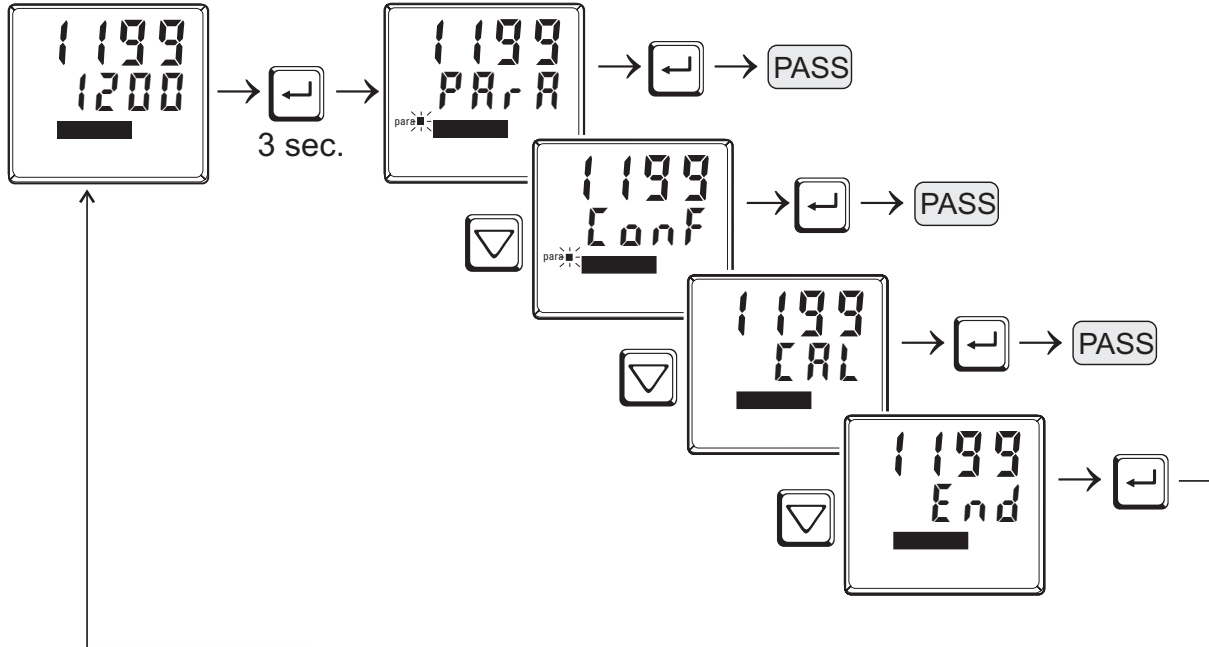

- i** **PAR A** - level: At **PAR A** - level, the right decimal point of the bottom display line is *lit continuously*.
- i** **CONF** - level: At **CONF** - level, the right decimal point of bottom display line *blinks*

**PASS**

When safety switch **Loc** is open, only the levels enabled by means of 8800/8840 configurator (engineering tool) are visible and accessible by entry of the password also adjusted by means of 8800/8840 configurator (engineering tool). Individual parameters accessible without password must be copied to the extended operating level.



- i** Factory setting: Safety switch **Loc** closed: all levels accessible without restriction, password **PASS = OFF**.
- i** All levels locked with a password are locked only if safety switch **Loc** is closed.

**4 Configuration level**

**4.1 Configuration survey**

CONF Configuration level													
Enter	Control and self-tuning	Input 1	Input 2	Input 3	Limit value functions	Output 1	Output 2	Output 3	Output 4	Output 5	Output 6	Digital inputs	Display, operation, interface
SPFn	IFnc	IFnc	IFnc	Fnc.1	ORct	See output 1	DEYP	DEYP	See output 1	See output 1	See output 1	Lr	bAud
DEYP	SEYP	SEYP	SL in	Src.1	Y.1		ORct	ORct				SP.2	Addr
CFnc	SL in	Corr	SEYP	Fnc.2	Y.2		Y.1	Y.1				SPE	Prty
Edif	Corr	Inf	Corr	Src.2	L in.1		Y.2	Y.2				Y.2	dELY
ñAn			Inf	Fnc.3	L in.2		L in.1	L in.1				YE	dPRd
ORct				Src.3	L in.3		L in.2	L in.2				ñAn	bcuP
FRIL				HCAL	dAcA		L in.3	L in.3				CoFF	OZ
rngL				LPAL	LPAL		dAcA	dAcA				ñLoc	Unit
rngH				dAcA	HCAL		LPAL	LPAL				Errr	dP
EYCL					HCSC		HCAL	HCAL				P id.2	LEd
EWnE					PEnd		HCSC	HCSC				ICHG	dISP
Strt					FR.1		PEnd	PEnd				dIFn	EdEL
					FR.2		FR.1	FR.1					
					FR.3	FR.2	FR.2						
						FR.3	FR.3						
						Out.0	Out.0						
						Out.1	Out.1						
						O.Src	O.Src						

**Adjustment:**

- The configuration can be adjusted by means of keys   .
- Transition to the next configuration is by pressing key  .
- After the last configuration of a group, donE is displayed and followed by automatic change to the next group

Return to the beginning of a group is by pressing the  key for 3 sec.

## 4.2 Configuration parameters

### Ctrl

Name	Value range	Description	Default
<b>SPFn</b>		<b>Basic configuration of setpoint processing</b>	0
	0	set-point controller can be switched over to external set-point (-> LOGI / SPE)	
	8	standard controller with external offset (SPE)	
<b>CLYP</b>		<b>Calculation of the process value</b>	0
	0	standard controller (process value = x1)	
	1	ratio controller (x1/x2)	
	2	difference (x1 - x2)	
	3	Maximum value of x1 and x2. It is controlled with the bigger value. At sensor failure it is controlled with the remaining actual value.	
	4	Minimum value of x1 and x2. It is controlled with the smaller value. At sensor failure it is controlled with the remaining actual value.	
	5	Mean value (x1, x2). With sensor error, controlling is continued with the remaining process value.	
	6	Switching between x1 and x2 (-> LOGI / I.C.H.G)	
	7	O <sub>2</sub> function with constant sensor temperature	
	8	O <sub>2</sub> function with measured sensor temperature	
<b>CFnc</b>		<b>Control behaviour (algorithm)</b>	1
	0	on/off controller or signaller with one output	
	1	PID controller (2-point and continuous)	
	2	$\Delta$ / Y / Off, or 2-point controller with partial/full load switch-over	
	3	2 x PID (3-point and continuous)	
	4	3-point stepping controller	
	5	3-point stepping controller with position feedback Yp	
	6	continuous controller with integrated positioner	
<b>CLdIF</b>		<b>Output action of the PID controller derivative action</b>	0
	0	Derivative action acts only on the measured value.	
	1	Derivative action only acts on the control deviation (set-point is also differentiated)	
<b>nAn</b>		<b>Manual operation permitted</b>	0
	0	no	
	1	yes (-> LOGI / nAn)	
<b>CRct</b>		<b>Method of controller operation</b>	0
	0	inverse, e.g. heating	
	1	direct, e.g. cooling	
<b>FAIL</b>		<b>Behaviour at sensor break</b>	1
	0	controller outputs switched off	
	1	y = Y2	
	2	y = mean output. The maximum permissible output can be adjusted with parameter YnH. To prevent determination of inadmissible values, mean value formation is only if the control deviation is lower than parameter L.Yn.	

Name	Value range	Description	Default
<b>rnl</b>	-1999...9999	<b>X0 (low limit range of control) ❶</b>	-100
<b>rnh</b>	-1999...9999	<b>X100 (high limit range of control) ❶</b>	1200
<b>cycle</b>		<b>Characteristic for 2-point- and 3-point-controllers</b>	0
	0	standard	
	1	water cooling linear	
	2	water cooling non-linear	
<b>tune</b>		<b>Auto-tuning at start-up (see page 16)</b>	0
	0	At start-up with step attempt, at set-point with impulse attempt	
	1	At start-up and at set-point with impulse attempt. Setting for fast controlled systems (e.g. hot runner control)	
<b>strt</b>		<b>Start of auto-tuning</b>	0
	0	Manual start of auto-tuning	
	1	Manual or automatic start of auto-tuning at power on or when oscillating is detected	
<b>Adt0</b>		<b>Optimization of T1, T2 (only visible with 8800/8840 configurator!)</b>	0
	0	Automatic optimization	
	1	No optimization	

❶ **rnl** and **rnh** are indicating the range of control on which e.g. the self-tuning is referring

## INP.1

Name	Value range	Description	Default
<b>INP.1</b>		<b>INP1 function selection</b>	7
	0	No function (following INP data are skipped)	
	1	Heating current input	
	2	External set-point <b>SPE</b> (switch-over -> <b>LOG1 / SPE</b> )	
	3	Position feedback <b>Yp</b>	
	4	Second process value <b>x2</b> (ratio, min, max, mean)	
	5	External positioning value <b>YE</b> (switch-over -> <b>LOG1 / YE</b> )	
	6	No controller input (e.g. limit signalling instead)	
	7	Process value <b>x1</b>	

Name	Value range	Description	Default
<b>5.tYP</b>		<b>Sensor type selection</b>	1
	0	thermocouple type L (-100...900°C) , Fe-CuNi DIN	
	1	thermocouple type J (-100...1200°C) , Fe-CuNi	
	2	thermocouple type K (-100...1350°C), NiCr-Ni	
	3	thermocouple type N (-100...1300°C), Nicrosil-Nisil	
	4	thermocouple type S (0...1760°C), PtRh-Pt10%	
	5	thermocouple type R (0...1760°C), PtRh-Pt13%	
	6	thermocouple type T (-200...400°C), Cu-CuNi	
	7	thermocouple type C (0...2315°C), W5%Re-W26%Re	
	8	thermocouple type D (0...2315°C), W3%Re-W25%Re	
	9	thermocouple type E (-100...1000°C), NiCr-CuNi	
	10	thermocouple type B (0/100...1820°C), PtRh-Pt6%	
	18	special thermocouple	
	20	Pt100 (-200.0 ... 100.0 °C)	
	21	Pt100 (-200.0 ... 850.0 °C)	
	22	Pt1000 (-200.0 ... 850.0 °C)	
	23	special 0...4500 Ohm (preset to KTY11-6)	
	24	special 0...450 Ohm	
	30	0...20mA / 4...20mA ①	
	40	0...10V / 2...10V ①	
	41	special -2,5...115 mV ①	
	42	special -25...1150 mV ①	
	50	potentiometer 0...160 Ohm ①	
	51	potentiometer 0...450 Ohm ①	
52	potentiometer 0...1600 Ohm ①		
53	potentiometer 0...4500 Ohm ①		
<b>5.L in</b>		<b>Linearization (only at 5.tYP = 23 (KTY 11-6), 24 (0...450 ), 30 (0..20mA), 40 (0..10V), 41 (0...100mV) and 42 (special -25...1150 mV))</b>	0
	0	none	
	1	Linearization to specification. Creation of linearization table with 8800/8840 configurator (engineering tool) possible. The characteristic for KTY 11-6 temperature sensors is preset.	
<b>Corr</b>		<b>Measured value correction / scaling</b>	0
	0	Without scaling	
	1	Offset correction (at <b>ERR</b> level)	
	2	2-point correction (at <b>ERR</b> level)	
	3	Scaling (at <b>ERR</b> level)	
<b>INF</b>	-1999...9999	<b>Alternative value for error at INP1</b>	<b>OFF</b>
<b>fAI1</b>		<b>Forcing INP1 (only visible with 8800/8840 configurator!)</b>	0
	0	No forcing	
	1	Forcing via serial interface	

① with current and voltage input signals, scaling is required (see chapter 5.3)



### INP.2

Name	Value range	Description	Default
I.Fnc		<b>Function selection of INP2</b>	1
	0	no function (subsequent input data are skipped)	
	1	heating current input	
	2	External set-point <i>SPE</i> (switch-over -> <i>LOG1 / SPE</i> )	
	3	Position feedback <i>Yp</i>	
	4	Second process value x2 (ratio, min, max, mean)	
	5	External positioning value <i>Y.E</i> (switch-over -> <i>LOG1 / Y.E</i> )	
	6	no controller input (e.g. transmitter input instead)	
S.EYP		<b>Sensor type selection</b>	30
	30	0...20mA / 4...20mA ❶	
	31	0...50mA AC ❶	
	50	Potentiometer ( 0...160 Ohm) ❶	
	51	Potentiometer ( 0...450 Ohm) ❶	
	52	Potentiometer ( 0...1600 Ohm) ❶	
	53	Potentiometer ( 0...4500 Ohm) ❶	
Corr		<b>Measured value correction / scaling</b>	0
	0	Without scaling	
	1	Offset correction (at <i>CR1</i> level)	
	2	2-point correction (at <i>CR1</i> level)	
I.n.F	-1999...9999	Scaling (at <i>PRR R</i> level)	
		<b>Alternative value for error at INP2</b>	OFF
fAI2		<b>Forcing INP2 (only visible with 8800/8840 configurator!)</b>	0
	0	No forcing	
	1	Forcing via serial interface	

❶ with current and voltage input signals, scaling is required (see chapter 5.3)

### INP.3

Name	Value range	Description	Default
I.Fnc		<b>Function selection of INP3</b>	1
	0	no function (subsequent input data are skipped)	
	1	heating current input	
	2	External set-point <i>SPE</i> (switch-over -> <i>LOG1 / SPE</i> )	
	3	<i>Yp</i> input	
	4	Second process value X2	
	5	External positioning value <i>Y.E</i> (switch-over -> <i>LOG1 / Y.E</i> )	
	6	no controller input (e.g. transmitter input instead)	
	7	Process value x1	

Name	Value range	Description	Default
<b>5.t 4P</b>		<b>Sensor type selection</b>	30
	0	thermocouple type L (-100...900°C) , Fe-CuNi DIN	
	1	thermocouple type J (-100...1200°C) , Fe-CuNi	
	2	thermocouple type K (-100...1350°C), NiCr-Ni	
	3	thermocouple type N (-100...1300°C), Nicrosil-Nisil	
	4	thermocouple type S (0...1760°C), PtRh-Pt10%	
	5	thermocouple type R (0...1760°C), PtRh-Pt13%	
	6	thermocouple type T (-200...400°C), Cu-CuNi	
	7	thermocouple type C (0...2315°C), W5%Re-W26%Re	
	8	thermocouple type D (0...2315°C), W3%Re-W25%Re	
	9	thermocouple type E (-100...1000°C), NiCr-CuNi	
	10	thermocouple type B (0/100...1820°C), PtRh-Pt6%	
	18	special thermocouple	
	20	Pt100 (-200,0 ... 100,0 °C)	
	21	Pt100 (-200,0 ... 850,0 °C)	
	22	Pt1000 (-200,0 ... 850,0 °C)	
	23	special 0...4500 Ohm (preset to KTY11-6)	
	24	special 0...450 Ohm	
	30	0...20mA / 4...20mA ①	
	41	special -2,5...115 mV ①	
42	special -25...115 0mV ①		
50	potentiometer 0...160 Ohm ①		
51	potentiometer 0...450 Ohm ①		
52	potentiometer 0...1600 Ohm ①		
53	potentiometer 0...4500 Ohm ①		
<b>5.L in</b>		<b>Linearization (only at 5.t 4P = 23,24,30,41 and 42 adjustable)</b>	0
	0	none	
	1	Linearization to specification. Creation of linearization table with 8800/8840 configurator (engineering tool) possible. The characteristic for KTY 11-6 temperature sensors is preset.	
<b>ε<sub>corr</sub></b>		<b>Measured value correction / scaling (only at 5.t 4P = 23,24,30,41 and 42 adjustable)</b>	0
	0	Without scaling	
	1	Offset correction (at ε <sub>RL</sub> level)	
	2	2-point correction (at ε <sub>RL</sub> level)	
	3	Scaling (at P <sub>RR</sub> level)	
4	Automatic calibration (DAC)		
<b>IN.F</b>	-1999...9999	<b>Alternative value for error at INP3</b>	0FF
<b>fAI3</b>		<b>Forcing INP3 (only visible with 8800/8840 configurator!)</b>	0
	0	No forcing	
	1	Forcing via serial interface	

① with current and voltage input signals, scaling is required (see chapter 5.3)

L 13

Name	Value range	Description	Default
<b>Fnc.1</b>		<b>Function of limit 1</b>	1
	0	switched off	
	1	measured value monitoring	
	2	Measured value monitoring + alarm status storage. A stored limit value can be reset via error list, <b>F</b> -key, <b>S</b> -key or a digital input (-> <b>LOG</b> / <b>Err.r</b> )	
	3	signal change (change/minute)	
	4	signal change and storage (change/minute)	
<b>Src.1</b>		<b>Source of limit 1</b>	1
	0	process value	
	1	control deviation xw (process value - set-point)	
	2	control deviation xw (with suppression after start-up and set-point change)  After switch-on or set-point changing, the alarm output is suppressed, until the process value is within the limits for the first time. At the latest after elapse of time 10 $t_{int}$ the alarm is activated ( $t_{int}$ = integral time 1; parameter -> <b>Int.r</b> ). If $t_{int}$ is switched off ( $t_{int} = 0$ ), this is interpreted as $\infty$ , i.e. the alarm is not activated, before the process value was within the limits once.	
	3	measured value INP1	
	4	measured value INP2	
	5	measured value INP3	
	6	effective setpoint Weff	
	7	correcting variable y (controller output)	
	8	control variable deviation xw (actual value - internal setpoint) = deviation alarm to internal setpoint	
9	difference x1 - x2 (utilizable e.g. in combination with process value function "mean value" for recognizing aged thermocouples)		
<b>Fnc.2</b>		<b>Function of limit 2</b>	0
	0	switched off	
	1	measured value monitoring	
	2	Measured value monitoring + alarm status storage. A stored limit value can be reset via error list, <b>F</b> -key, <b>S</b> -key or a digital input (-> <b>LOG</b> / <b>Err.r</b> )	
	3	signal change (change/minute)	
	4	signal change and storage (change/minute)	

Name	Value range	Description	Default
<b>Src.2</b>		<b>Source of limit 2</b>	0
	0	process value	
	1	control deviation xw (process value - set-point)	
	2	control deviation xw (with suppression after start-up and set-point change)  After switch-on or set-point changing, the alarm output is suppressed, until the process value is within the limits for the first time. At the latest after elapse of time 10 $t_{int}$ the alarm is activated ( $t_{int}$ = integral time I; parameter → <b>Int.r</b> ) If $t_{int}$ is switched off ( $t_{int} = 0$ ), this is interpreted as $\infty$ , i.e. the alarm is not activated, before the process value was within the limits once.	
	3	measured value INP1	
	4	measured value INP2	
	5	measured value INP3	
	6	effective setpoint Weff	
	7	correcting variable y (controller output)	
	8	control variable deviation xw (actual value - internal setpoint) = deviation alarm to internal setpoint	
9	difference x1 - x2 (utilizable e.g. in combination with process value function "mean value" for recognizing aged thermocouples)		
<b>Fnc.3</b>		<b>Function of limit 3</b>	0
	0	switched off	
	1	measured value monitoring	
	2	Measured value monitoring + alarm status storage. A stored limit value can be reset via error list, <b>F</b> -key, <b>ESC</b> -key or a digital input (-> <b>Limit / Error</b> )	
	3	signal change (change/minute)	
	4	signal change and storage (change/minute)	

Name	Value range	Description	Default
<b>Src3</b>		<b>Source of limit 3</b>	0
	0	process value	
	1	control deviation xw (process value - set-point)	
	2	control deviation xw (with suppression after start-up and set-point change)  After switch-on or set-point changing, the alarm output is suppressed, until the process value is within the limits for the first time. At the latest after elapse of time 10 $t_{int}$ the alarm is activated $t_{int}$ = integral time I; parameter $\rightarrow t_{int}$ If $t_{int}$ is switched off ( $t_{int} = 0$ ), this is interpreted as $\infty$ , i.e. the alarm is not activated, before the process value was within the limits once.	
	3	measured value INP1	
	4	measured value INP2	
	5	measured value INP3	
	6	effective setpoint W <sub>eff</sub>	
	7	correcting variable y (controller output)	
	8	control variable deviation xw (actual value - internal setpoint) = deviation alarm to internal setpoint	
9	difference x1 - x2 (utilizable e.g. in combination with process value function "mean value" for recognizing aged thermocouples)		
<b>HEAL</b>		<b>Alarm heat current function (INP2)</b>	0
	0	switched off	
	1	Overload short circuit monitoring	
<b>LPAL</b>	2	Break and short circuit monitoring	
		<b>Monitoring of control loop interruption for heating</b>	0
<b>LPAL</b>	0	switched off / inactive	
	1	active. If $t_{int} = 0$ LOOP alarm is inactive!	
<b>DACR</b>		<b>DAC alarm function</b>	0
	0	DAC alarm switched off / inactive	
	1	DAC alarm active	
Hour	OFF...999999	<b>Operating hours</b> (only visible with 8800/8840 configurator!)	OFF
Swit	OFF...999999	<b>Output switching cycles</b> (only visible with 8800/8840 configurator!)	OFF

### Out. 1

Name	Value range	Description	Default
<b>Out1</b>		<b>Method of operation of output OUT1</b>	0
	0	direct / normally open	
	1	inverse / normally closed	
<b>Y1</b>		<b>Controller output Y1</b>	1
	0	not active	
	1	active	

Name	Value range	Description	Default
Y2		<b>Controller output Y2</b>	0
	0	not active	
	1	active	
LIn.1		<b>Limit 1 signal</b>	0
	0	not active	
	1	active	
LIn.2		<b>Limit 2 signal</b>	0
	0	not active	
	1	active	
LIn.3		<b>Limit 3 signal</b>	0
	0	not active	
	1	active	
dRcR		<b>Valve monitoring (DAC)</b>	0
	0	not active	
	1	active	
LPAL		<b>Interruption alarm signal (LOOP)</b>	0
	0	not active	
	1	active	
HCAL		<b>Heat current alarm signal</b>	0
	0	not active	
	1	active	
HCSL		<b>Solid state relay (SSR) short circuit signal</b>	0
	0	not active	
	1	active	
FR.1		<b>INP1 error signal</b>	0
	0	not active	
	1	active	
FR.2		<b>INP2 error signal</b>	0
	0	not active	
	1	active	
FR.3		<b>INP3 error signal</b>	0
	0	not active	
	1	aktiv	
fOut		<b>Forcing OUT1 (only visible with 8800/8840 configurator!)</b>	0
	0	No forcing	
	1	Forcing via serial interface	

### Out.2

Configuration parameters Out.2 = Out.1 except for: Default Y.1 = 0 Y.2 = 1

## OUT3

Name	Value range	Description	Default
O.TYP		<b>Signal type selection OUT3</b>	0
	0	relay / logic (only visible with current/logic voltage)	
	1	0 ... 20 mA continuous (only visible with current/logic/voltage)	
	2	4 ... 20 mA continuous (only visible with current/logic/voltage)	
	3	0...10 V continuous (only visible with current/logic/voltage)	
	4	2...10 V continuous (only visible with current/logic/voltage)	
	5	transmitter supply (only visible without OPTION)	
O.RCT		<b>Method of operation of output OUT3 (only visible when O.TYP=0)</b>	1
	0	direct / normally open	
	1	inverse / normally closed	
Y.1		<b>Controller output Y1 (only visible when O.TYP=0)</b>	0
	0	not active	
	1	active	
Y.2		<b>Controller output Y2 (only visible when O.TYP=0)</b>	0
	0	not active	
	1	active	
L.ln.1		<b>Limit 1 signal (only visible when O.TYP=0)</b>	1
	0	not active	
	1	active	
L.ln.2		<b>Limit 2 signal (only visible when O.TYP=0)</b>	0
	0	not active	
	1	active	
L.ln.3		<b>Limit 3 signal (only visible when O.TYP=0)</b>	0
	0	not active	
	1	active	
dRc.R		<b>Valve monitoring (DAC) (only visible when O.TYP=0)</b>	0
	0	not active	
	1	active	
LP.AL		<b>Interruption alarm signal (LOOP) (only visible when O.TYP=0)</b>	0
	0	not active	
	1	active	
HC.AL		<b>Heating current alarm signal (only visible when O.TYP=0)</b>	0
	0	not active	
	1	active	
HC.SC		<b>Solid state relay (SSR) short circuit signal (only visible when O.TYP=0)</b>	0
	0	not active	
	1	active	

Name	Value range	Description	Default
FR .1		<b>INP1 error (only visible when O.TYP=0)</b>	1
	0	not active	
	1	active	
FR .2		<b>INP2 error (only visible when O.TYP=0)</b>	0
	0	not active	
	1	active	
FR .3		<b>INP3 error (only visible when O.TYP=0)</b>	0
	0	not active	
	1	aktiv	
OUT.0	-1999...9999	<b>Scaling of the analog output for 0% (0/4mA or 0/2V, only visible when O.TYP=1..5)</b>	0
OUT.1	-1999...9999	<b>Scaling of the analog output for 100% (20mA or 10V, only visible when O.TYP=1..5)</b>	100
O.Src		<b>Signal source of the analog output OUT3 (only visible when O.TYP=1..5)</b>	1
	0	not used	
	1	controller output y1 (continuous)	
	2	controller output y2 (continuous)	
	3	process value	
	4	effective set-point Weff	
	5	control deviation xw (process value - set-point)	
	6	measured value position feedback Yp	
	7	measured value INP1	
	8	measured value INP2	
9	measured value INP3		
fOut		<b>Forcing OUT3 (only visible with 8800/8840 configurator!)</b>	0
	0	No forcing	
	1	Forcing via serial interface	

### OUT.4

Name	Value range	Description	Default
O.TYP		<b>Signal type selection OUT4</b>	0
	0	relay / logic (only visible with current/logic voltage)	
	1	0 ... 20 mA continuous (only visible with current/logic/voltage)	
	2	4 ... 20 mA continuous (only visible with current/logic/voltage)	
	3	0...10 V continuous (only visible with current/logic/voltage)	
	4	2...10 V continuous (only visible with current/logic/voltage)	
	5	transmitter supply (only visible without OPTION)	
O.Rct		<b>Method of operation of output OUT4 (only visible when O.TYP=0)</b>	0
	0	direct / normally open	
	1	inverse / normally closed	



Name	Value range	Description	Default
Y.1		<b>Controller output Y1 (only visible when O.TYP=0)</b>	0
	0	not active	
	1	active	
Y.2		<b>Controller output Y2 (only visible when O.TYP=0)</b>	0
	0	not active	
	1	active	
L.in.1		<b>Limit 1 signal (only visible when O.TYP=0)</b>	0
	0	not active	
	1	active	
L.in.2		<b>Limit 2 signal (only visible when O.TYP=0)</b>	0
	0	not active	
	1	active	
L.in.3		<b>Limit 3 signal (only visible when O.TYP=0)</b>	0
	0	not active	
	1	active	
dA.c.A		<b>Valve monitoring (DAC) (only visible when O.TYP=0)</b>	0
	0	not active	
	1	active	
LP.AL		<b>Interruption alarm signal (LOOP) (only visible when O.TYP=0)</b>	0
	0	not active	
	1	active	
HC.AL		<b>Heat current alarm signal (only visible when O.TYP=0)</b>	0
	0	not active	
	1	active	
HC.SC		<b>Solid state relay (SSR) short circuit signal (only visible when O.TYP=0)</b>	0
	0	not active	
	1	active	
FA.in.1		<b>INP1 error (only visible when O.TYP=0)</b>	0
	0	not active	
	1	active	
FA.in.2		<b>INP2 error (only visible when O.TYP=0)</b>	0
	0	not active	
	1	active	
FA.in.3		<b>INP3 error (only visible when O.TYP=0)</b>	0
	0	not active	
	1	aktiv	
Oub.0	-1999...9999	<b>Scaling of the analog output for 0% (0/4mA or 0/2V, only visible when O.TYP=1..5)</b>	0
Oub.1	-1999...9999	<b>Scaling of the analog output for 100% (20mA or 10V, only visible when O.TYP=1..5)</b>	100

Name	Value range	Description	Default
O.Src		Signal source of the analog output OUT4 (only visible when O.TYP=1..5)	0
	0	not used	
	1	controller output y1 (continuous)	
	2	controller output y2 (continuous)	
	3	process value	
	4	effective set-point Weff	
	5	control deviation xw (process value - set-point)	
fOut		<b>Forcing OUT1</b> (only visible with 8800/8840 configurator!)	0
	0	No forcing	
	1	Forcing via serial interface	

### Out.5

Configuration parameters Out.2 = Out.1 except for: Default  $y.1 = 0$   $y.2 = 0$

### Out.6

Configuration parameters Out.2 = Out.1 except for: Default  $y.1 = 0$   $y.2 = 0$











### Method of operation and usage of output Out.1 to Out.5:





Is more than one signal chosen active as source, those signals are OR-linked.

### LOG1

Name	Value range	Description	Default
L.Sr		<b>Local / Remote switching (Remote: adjusting of all values by front keys is blocked)</b>	0
	0	no function (switch-over via interface is possible)	
	1	always active	
	2	DI1 switches	
	3	DI2 switches (only visible with OPTION)	
	4	DI3 switches (only visible with OPTION)	
SP.2		<b>Switching to second setpoint SP.2</b>	0
	0	no function (switch-over via interface is possible)	
	2	DI1 switches	
	3	DI2 switches (only visible with OPTION)	
	4	DI3 switches (only visible with OPTION)	
	5	<input type="checkbox"/> - key switches	

Name	Value range	Description	Default
<b>SP.E</b>		<b>Switching to external setpoint SP.E</b>	0
	0	no function (switch-over via interface is possible)	
	1	always active	
	2	DI1 switches	
	3	DI2 switches (only visible with OPTION)	
	4	DI3 switches (only visible with OPTION)	
<b>Y2</b>	5	 - key switches	
		<b>Y/Y2 switching</b>	0
	0	no function (switch-over via interface is possible)	
	2	DI1 switches	
	3	DI2 switches (only visible with OPTION)	
	4	DI3 switches (only visible with OPTION)	
<b>YE</b>	5	 - key switches	
	6	 - key switches	
		<b>Switching to fixed control output YE</b>	0
	0	no function (switch-over via interface is possible)	
	1	always activated (manual station)	
	2	DI1 switches	
<b>MAN</b>	3	DI2 switches (only visible with OPTION)	
	4	DI3 switches (only visible with OPTION)	
	5	 - key switches	
	6	 - key switches	
		<b>Automatic/manual switching</b>	0
	0	no function (switch-over via interface is possible)	
<b>COFF</b>	1	always activated (manual station)	
	2	DI1 switches	
	3	DI2 switches (only visible with OPTION)	
	4	DI3 switches (only visible with OPTION)	
	5	 - key switches	
	6	 - key switches	
<b>BLoc</b>		<b>Blockage of hand function</b>	0
	0	no function (switch-over via interface is possible)	
	2	DI1 switches	
	3	DI2 switches (only visible with OPTION)	
	4	DI3 switches (only visible with OPTION)	
	5	 - key switches	

## Configuration level

Name	Value range	Description	Default
<b>Err_r</b>		<b>Reset of all error list entries</b>	0
	0	no function (switch-over via interface is possible)	
	2	DI1 switches	
	3	DI2 switches (only visible with OPTION)	
	4	DI3 switches (only visible with OPTION)	
	5	 - key switches	
	6	 - key switches	
<b>Pr_d2</b>		<b>Switching of parameter set (Pb, ti, td)</b>	0
	0	no function (switch-over via interface is possible)	
	2	DI1 switches	
	3	DI2 switches (only visible with OPTION)	
	4	DI3 switches (only visible with OPTION)	
	5	 - key switches	
<b>l.ch0</b>		<b>Switching of the actual process value between Inp1 and X2</b>	0
	0	no function (switch-over via interface is possible)	
	2	DI1 switches	
	3	DI2 switches (only visible with OPTION)	
	4	DI3 switches (only visible with OPTION)	
	5	 - key switches	
<b>diFn</b>		<b>Function of digital inputs (valid for all inputs)</b>	0
	0	direct	
	1	inverse	
	2	toggle key function	
<b>fDI1</b>		<b>Forcing di1 (only visible with 8800/8840 configurator!)</b>	0
	0	No forcing	
	1	Forcing via serial interface	
<b>fDI2</b>		<b>Forcing di2 (only visible with 8800/8840 configurator!)</b>	0
	0	No forcing	
	1	Forcing via serial interface	
<b>fDI3</b>		<b>Forcing di3 (only visible with 8800/8840 configurator!)</b>	0
	0	No forcing	
	1	Forcing via serial interface	

### o.k.h.r

Name	Value range	Description	Default
<b>bAud</b>		<b>Baudrate of the interface (only visible with OPTION)</b>	2
	0	2400 Baud	
	1	4800 Baud	
	2	9600 Baud	
	3	19200 Baud	
<b>Addr</b>	1...247	<b>Address on the interace (only visible with OPTION)</b>	1

Name	Value range	Description	Default
<b>PrEtY</b>		<b>Data parity on the interface (only visible with OPTION)</b>	1
	0	no parity (2 stop bits)	
	1	even parity	
	2	odd parity	
	3	no parity (1 stopbit)	
<b>dELy</b>	0...200	<b>Delay of response signal [ms] (only visible with OPTION)</b>	0
<b>02</b>		<b>Entering parameter for O<sub>2</sub> in ppm or %</b>	0
	0	Parameter for O <sub>2</sub> -function in ppm	
	1	Parameter for O <sub>2</sub> -function in %	
<b>Unit</b>		<b>Unit</b>	1
	0	without unit	
	1	°C	
	2	°F	
<b>dP</b>		<b>Decimal point (max. number of digits behind the decimal point)</b>	0
	0	no digit behind the decimal point	
	1	1 digit behind the decimal point	
	2	2 digits behind the decimal point	
	3	3 digits behind the decimal point	
<b>LEd</b>		<b>Function allocation of status LEDs 1 / 2 / 3 / 4</b>	0
	10	OUT1, OUT2, OUT3, OUT4	
	11	Heating, alarm 1, alarm 2, alarm 3	
	12	Heating, cooling, alarm 1, alarm 2	
	13	Cooling, heating, alarm 1, alarm 2	
	14	Bus error	
	20	Y1, Y2, track1, track2	
	21	Y2, Y1, track1, track2	
	22	track1, track2, track3, track4	
<b>dISP</b>	0...10	<b>Display luminosity</b>	5
<b>LdEL</b>	0..200	<b>Modem delay [ms]</b> Additional delay time, before the received message is evaluated in the Modbus. This time is required, unless messages are transferred continuously during modem transmission.	0
<b>dPRd</b>	0...126	<b>Profibus address</b>	126
<b>bcuP</b>		<b>Behaviour as backup controller</b>	0
	0	No backup functionality	
	1	With backup functionality	
<b>FrEq</b>		<b>Switching 50 Hz / 60 Hz (only visible with 8800/8840 configurator!)</b>	0
	0	50 Hz	
	1	60 Hz	
<b>ICof</b>		<b>Block controller off (only visible with 8800/8840 configurator!)</b>	0
	0	Released	
	1	Blocked	

## Configuration level

Name	Value range	Description	Default
IAda		<b>Block auto tuning</b> (only visible with 8800/8840 configurator!)	0
	0	Released	
	1	Blocked	
IExo		<b>Block extended operating level</b> (only visible with 8800/8840 configurator!)	0
	0	Released	
	1	Blocked	
ILat		Suppression error storage	0
	0	Released	
	1	Blocked	
Pass	OFF...9999	<b>Password</b> (only visible with 8800/8840 configurator!)	OFF
IPar		<b>Block parameter level</b> (only visible with 8800/8840 configurator!)	0
	0	Released	
	1	Blocked	
ICnf		<b>Block configuration level</b> (only visible with 8800/8840 configurator!)	0
	0	Released	
	1	Block	
ICal		<b>Block calibration level</b> (only visible with 8800/8840 configurator!)	0
	0	Released	
	1	Blocked	
CDis3		<b>Display 3 controller operating level</b> (only visible with 8800/8840 configurator!)	2
	0	No value / only text	
	1	Display of value	
	2	Output value as bargraph	
	3	Control deviation as bargraph	
	4	Process value as bargraph	
TDis3	2...60	<b>Display 3 display alternation time [s]</b> (only visible with 8800/8840 configurator!)	10
PDis3		display 3 programmer-operating level	0
	0	Segm.-No., Segm.-Type, Progr.-remaining time	
	1	Segm.-No., Segm.-Type, Segm.-remaining time	
	2	Segm.-No., Segm.-Type, net-time	
	3	Segm.-No., Segm.-Type, Progr.-remaining time	
	4	Segm.-No., Segm.-Type, Segm.-remaining time	
	5	Segm.-No., Segm.-Type, net-time	
T.dis3	8 characters	<b>Text display 3</b>	
T.InF1	8 characters	<b>Text Inf.1</b>	
T.InF2	8 characters	<b>Text Inf.2</b>	
t.PrG01	8 characters	Text Program 1	
t.PrG02	8 characters	Text Program 2	
• • •			
t.PrG16	8 characters	Text Program16	

**L i n** (only visible with 8800/8840 configurator)

Name	Value range	Description	Default
<b>L i n</b>		<b>Linearization for inputs INP1 or INP3</b> Access to this table is always with selection special thermocouple for <b>i n P. 1</b> or <b>i n P. 3</b> or with setting <b>S.L i n = 1</b> : special linearization for linearization. Default: KTY 11-6 (0...4,5 kOhm)	
<b>i n. 1</b>	-999.0..99999	<b>Input value 1</b> The signal is in [ $\mu$ V] or in [ $\Omega$ ] dependent of input type	1036
<b>O u. 1</b>	0,001...9999	<b>Output value 1</b> Signal assigned to <b>i n. 1</b>	-49,94
<b>i n. 2</b>	-999.0..99999	<b>Input value 2</b> The signal is in [ $\mu$ V] or in [ $\Omega$ ] dependent of input type	1150
<b>O u. 2</b>	0,001...9999	<b>Output value 2</b> Signal assigned to <b>i n. 2</b>	-38,94
⋮	⋮	⋮	⋮
<b>i n. 16</b>	-999.0..99999	<b>Input value 16</b> The signal is in [ $\mu$ V] or in [ $\Omega$ ] dependent of input type	4470
<b>O u. 16</b>	0,001...9999	<b>Output value 1 6</b> Signal assigned to <b>i n. 16</b>	150,0

 Resetting the controller configuration to factory setting (Default)  
→ **chapter 11.1 (page 82)**

 **8800/8840 configurator - the engineering tool for the West controller series**

3 engineering tools with different functionality facilitating 8800 process controller configuration and parameter setting are available (see chapter 9: *Accessory equipment with ordering information*).

In addition to configuration and parameter setting, 8800/8840 configurator is used for data acquisition and offers long-term storage and print functions.

8800/8840 configurator is connected to 8800 process controller via the front-panel interface by means of PC (Windows 95 / 98 / NT) and a PC adaptor. Description 8800/8840 configurator: see chapter 8: *8800/8840 configurator* (page 74).

### 4.3 Set-point processing

The set-point processing structure is shown in the following picture:

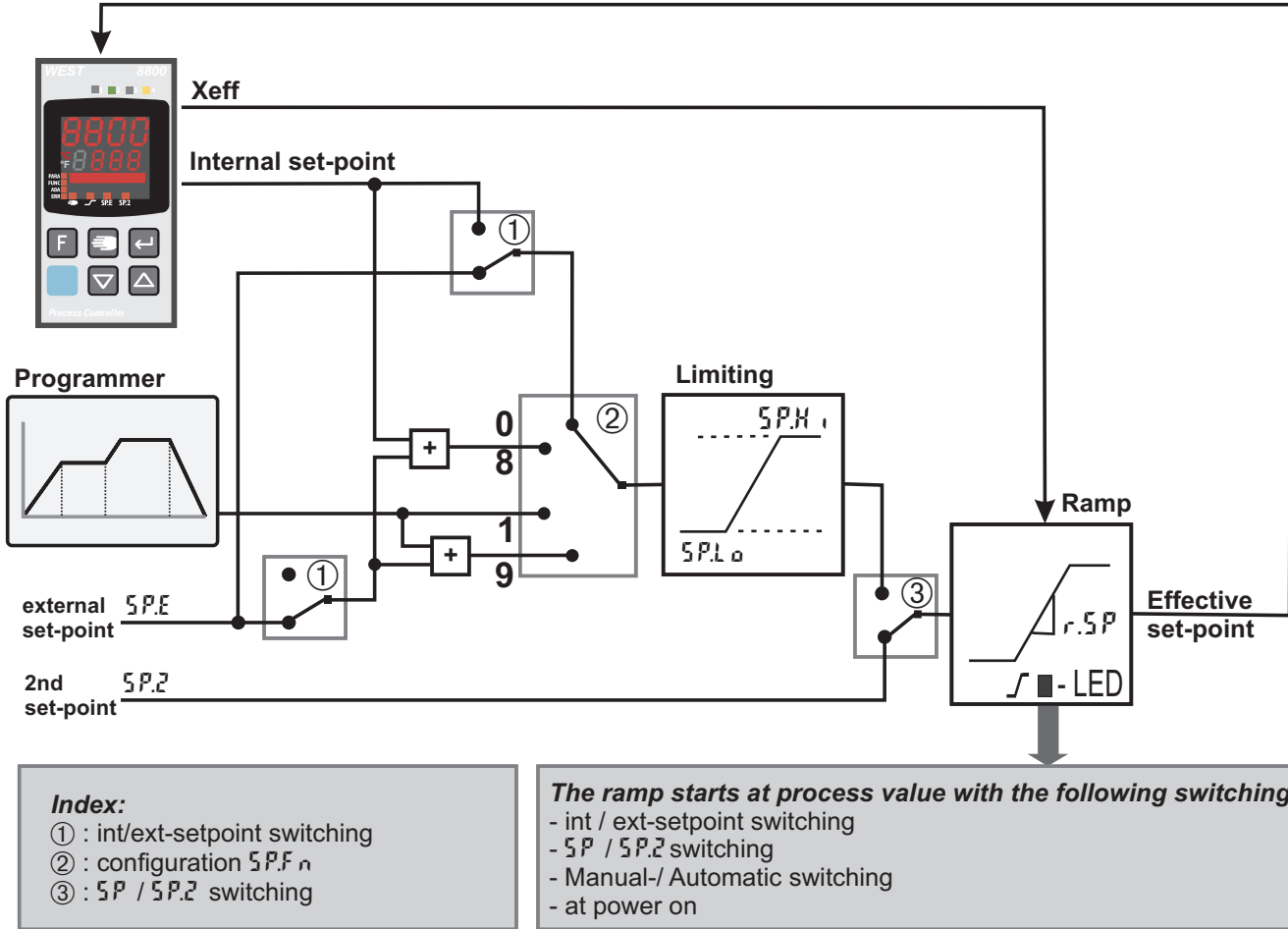

#### 4.3.1 Set-point gradient / ramp

To prevent set-point step changes, parameter → set-point →  $r.SP$  can be adjusted to a maximum rate of change. This gradient is effective in positive and negative direction..

With parameter  $r.SP$  set to **OFF** (default), the gradient is switched off and set-point changes are realized directly.  
(for parameter: see page48 )



## 4.4 Switching behaviour

With 8800 process controller, configuration parameter  $\tau$  (CONF/ENTER/ $\tau$ ) can be used for matching the cycle time of 2-point and 3-point controllers. This can be done using the following 4 methods.

### 4.4.1 Standard ( $\tau = 0$ )

The adjusted cycle times  $t_1$  and  $t_2$  are valid for 50% or -50% correcting variable. With very small or very high values, the effective cycle time is extended to prevent unreasonably short on and off pulses. The shortest pulses result from  $\frac{1}{4} \times t_1$  or  $\frac{1}{4} \times t_2$ . The characteristic curve is also called “bath tub curve”

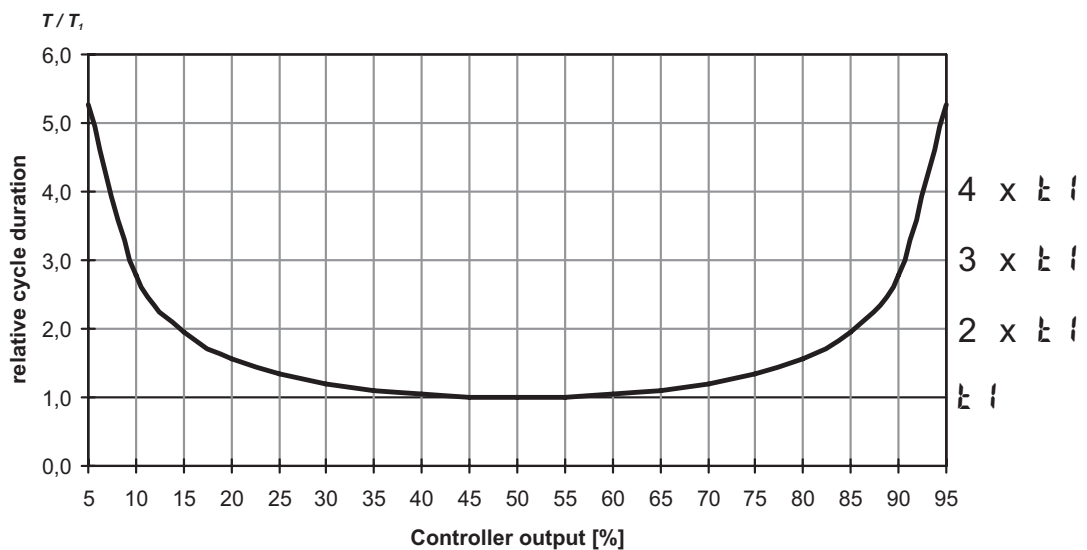

**Parameters to be adjusted:**  $t_1$  : min. cycle time 1 (heating) [s]  
 (PRR/ENTER)  $t_2$  : min. cycle time 2 (cooling) [s]

### 4.4.2 Switching attitude linear ( $\tau = 1$ )

For heating ( $\tau_1$ ), the standard method (see chapter 4.4.1) is used. For cooling ( $\tau_2$ ), a special algorithm for cooling with water is used. Generally, cooling is enabled only at an adjustable process temperature ( $\tau_{20}$ ), because low temperatures prevent evaporation with related

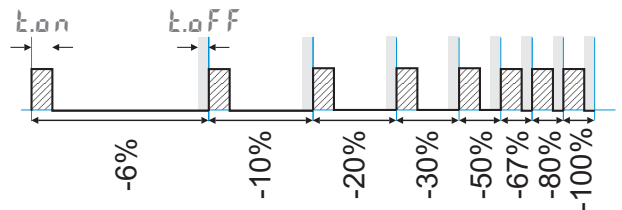

cooling, whereby damage to the plant is avoided. The cooling pulse length is adjustable using parameter  $t_{on}$  and is fixed for all output values.

The “off” time is varied dependent of output value. Parameter  $t_{off}$  is used for determining the min “off” time. For output of a shorter off pulse, this pulse is suppressed, i.e. the max. effective cooling output value is calculated according to formula  $t_{on} / (t_{on} + t_{off}) \cdot 100\%$ .

**Parameters to be adjusted:**  $E.H20$ : minimum temperature for water cooling  
 (  $P.A.R.A / C.n.t.r$  )  $t.on$ : pulse duration water cooling  
 $t.off$ : minimum pause water cooling

### 4.4.3 Switching attitude non-linear ( $C.Y.C.L = 2$ )

With this method, the cooling power is normally much higher than the heating power, i.e. the effect on the behaviour during transition from heating to cooling may be negative. The cooling curve ensures that the control intervention with 0 to -70% correcting variable is very weak.

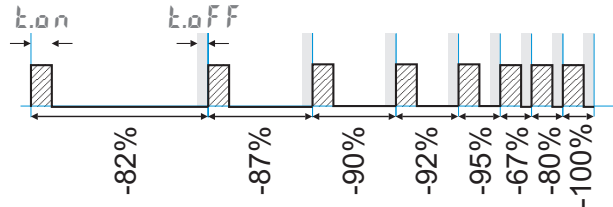

Moreover, the correcting variable increases very quickly to max. possible cooling. Parameter  $F.H20$  can be used for changing the characteristic curve. The standard method (see section 4.4.1) is also used for heating. Cooling is also enabled dependent of process temperature .

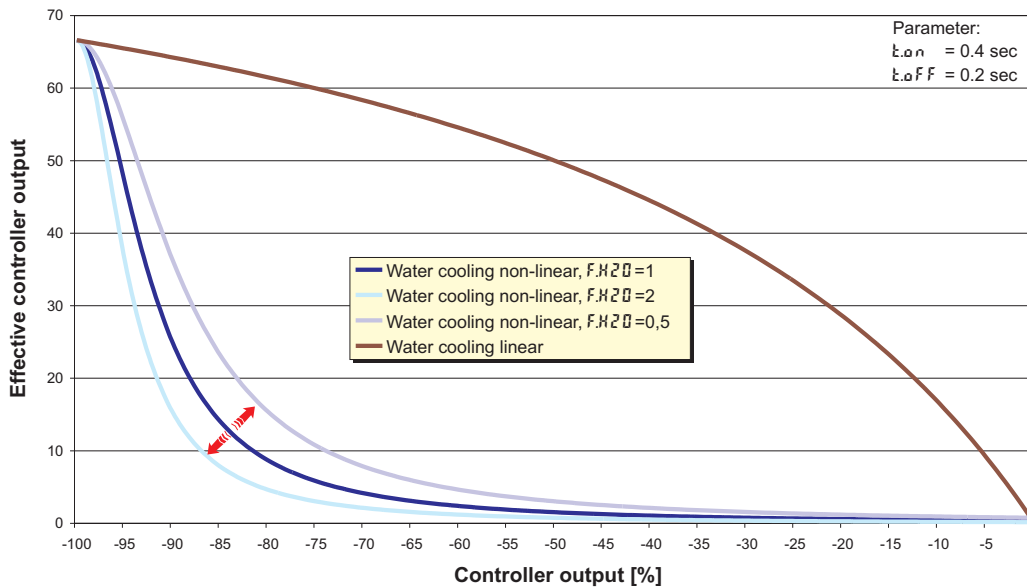

**Parameters to be adjusted:**  $F.H20$ : adaptation of (non-linear) characteristic  
 (  $P.A.R.A / C.n.t.r$  ) Water cooling  
 $t.on$ : Pulse duration water cooling  
 $t.off$ : min. pause water cooling  
 $E.H20$ : min. temperature for water cooling

4.4.4 Heating and cooling with constant period ( $\tau_1/\tau_2 = 3$ )

$\tau_1$  and  $\tau_2$  are met in the overall output range. To prevent unreasonably short pulses, parameter  $\tau_P$  is used for adjusting the shortest pulse duration. With small correcting values which require a pulse shorter than the value adjusted in  $\tau_P$ , this pulse is suppressed. However, the controller stores the pulse and totalizes further pulses, until a pulse of duration  $\tau_P$  can be output.

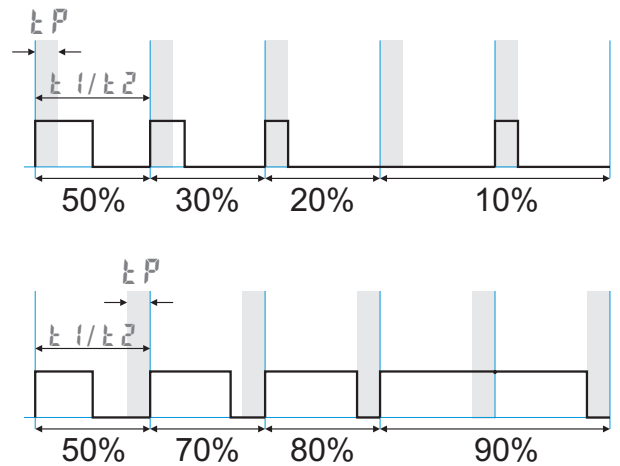

**Parameters to be adjusted:**  
( $\tau_1, \tau_2, \tau_P$ )

- $\tau_1$  : Min. cycle time 1 (heating) [s]
- $\tau_2$  : min. cycle time 2 (cooling) [s]
- $\tau_P$  : min. pulse length [s]

4.5 Configuration examples

4.5.1 On-Off controller / Signaller (inverse)

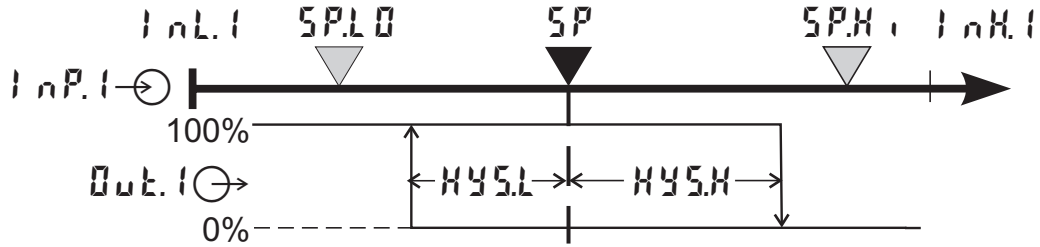

- CONF / Contr: SPFn = 0 set-point controller
- CFnc = 0 signaller with one output
- CAct = 0 inverse action  
(e.g. heating applications)
- CONF / Out.1: OAct = 0 action Out.1 direct
- Y1 = 1 control output Y1 active
- PARA / Contr: HYS.L = 0...9999 switching difference below SP
- PARA / Contr: HYS.H = 0...9999 switching difference above SP
- PARA / SEtP: SP.L0 = -1999...9999 set-point limit low for Weff
- SP.H0 = -1999...9999 set-point limit high for Weff

**i** For direct signaller action, the controller action must be changed (CONF / Contr / CAct = 1)

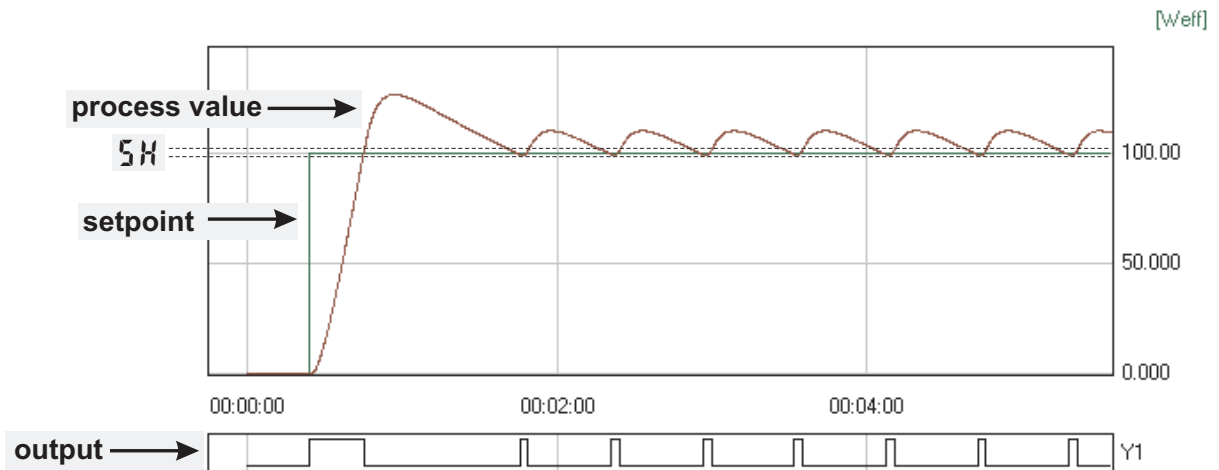

4.5.2 2-point controller (inverse)

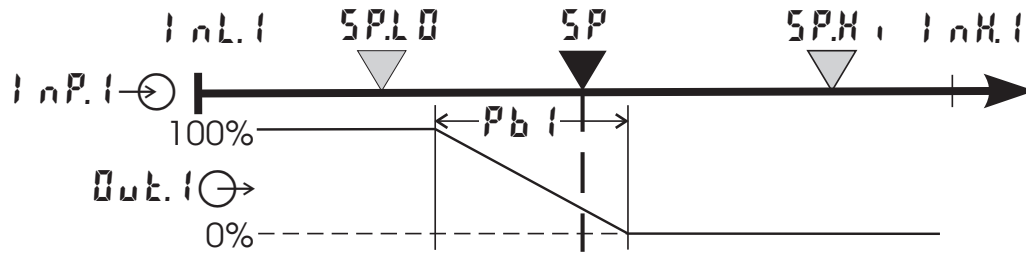

CONF / ENTR:	SPFn = 0	set-point controller
	CFnc = 1	2-point controller (PID)
	CAct = 0	inverse action (e.g. heating applications)
CONF / OUT.1:	ORct = 0	action Out.1 direct
	Y1 = 1	control output Y1 active
PARA / ENTR:	Pb1 = 1...9999	proportional band 1 (heating) in units of phys. quantity (e.g. °C)
	t11 = 0,1...9999	integral time 1 (heating) in sec.
	td1 = 0,1...9999	derivative time 1 (heating) in sec.
	t1 = 0,4...9999	min. cycle time 1 (heating)
PARA / SEtP:	SP.L0 = -1999...9999	set-point limit low for Weff
	SP.H.1 = -1999...9999	set-point limit high for Weff

**i** For direct action, the controller action must be changed (CONF / ENTR / CACT = 1).

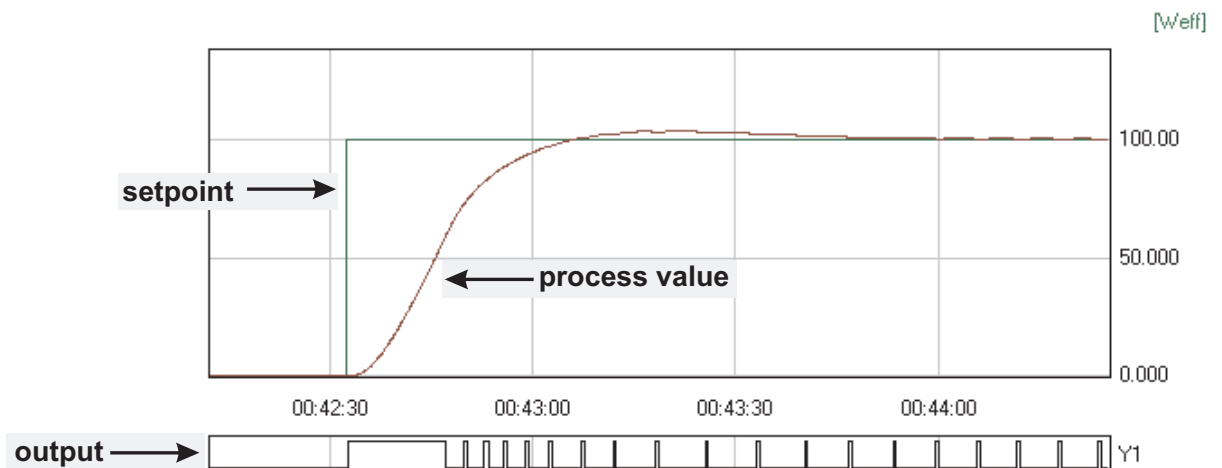

4.5.3 3-point controller (relay & relay)

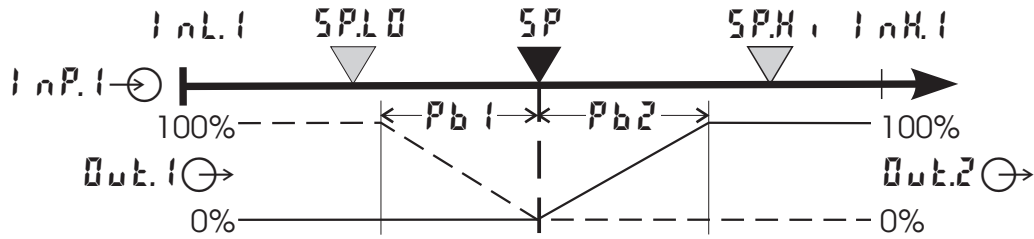

CONF / CONTR:	SPFn	= 0	set-point controller
	CFnc	= 3	3-point controller (2xPID)
	CAct	= 0	action inverse (e.g. heating applications)
CONF / Out.1:	ORct	= 0	action Out.1 direct
	y1	= 1	control output Y1 active
	y2	= 0	control output Y2 not active
CONF / Out.2:	ORct	= 0	action Out.2 direct
	y1	= 0	control output Y1 not active
	y2	= 1	control output Y2 active
PARA / CONTR:	Pb1	= 1...9999	proportional band 1 (heating) in units of phys. quantity (e.g. °C)
	Pb2	= 1...9999	proportional band 2 (cooling) in units of phys. quantity (e.g. °C)
	t i1	= 0,1...9999	integral time 1 (heating) in sec.
	t i2	= 0,1...9999	derivative time 2 (cooling) in sec.
	t d1	= 0,1...9999	integral time 1 (heating) in sec.
	t d2	= 0,1...9999	derivative time 2 (cooling) in sec.
	t1	= 0,4...9999	min. cycle time 1 (heating)
	t2	= 0,4...9999	min. cycle time 2 (cooling)
	SH	= 0...9999	neutr. zone in units of phys.quantity
PARA / SEtP:	SP.LO	= -1999...9999	set-point limit low for Weff
	SP.HI	= -1999...9999	set-point limit high for Weff

4.5.4 3-point stepping controller (relay & relay)

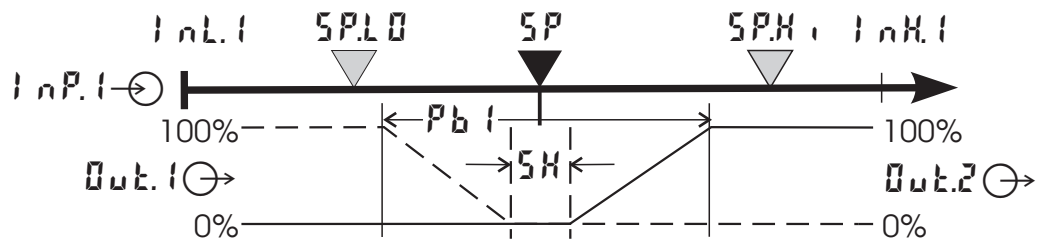

<b>CONF / ENTR:</b>	<b>SPFn</b> = 0	set-point controller
	<b>CFnc</b> = 4	3-point stepping controller
	<b>CAct</b> = 0	inverse action
		(e.g. heating applications)
<b>CONF / Out.1:</b>	<b>ORAct</b> = 0	action <b>Out.1</b> direct
	<b>Y1</b> = 1	control output Y1 active
	<b>Y2</b> = 0	control output Y2 not active
<b>CONF / Out.2:</b>	<b>ORAct</b> = 0	action <b>Out.2</b> direct
	<b>Y1</b> = 0	control output Y1 not active
	<b>Y2</b> = 1	control output Y2 active
<b>PRrR / ENTR:</b>	<b>Pb1</b> = 1...9999	proportional band 1 (heating) in units of phys. quantity (e.g. °C)
	<b>t i 1</b> = 0,1...9999	integral time 1 (heating) in sec.
	<b>t d 1</b> = 0,1...9999	derivative time 1 (heating) in sec.
	<b>t 1</b> = 0,4...9999	min. cycle time 1 (heating)
	<b>SH</b> = 0...9999	neutral zone in units of phys. quantity
	<b>tP</b> = 0,1...9999	min. pulse length in sec.
	<b>t t</b> = 3...9999	actuator travel time in sec.
<b>PRrR / SEtP:</b>	<b>SP.L0</b> = -1999...9999	set-point limit low for Weff
	<b>SP.H, 1</b> = -1999...9999	set-point limit high for Weff

**i** For direct action of the 3-point stepping controller, the controller output action must be changed (**CONF / ENTR / CAct** = 1).

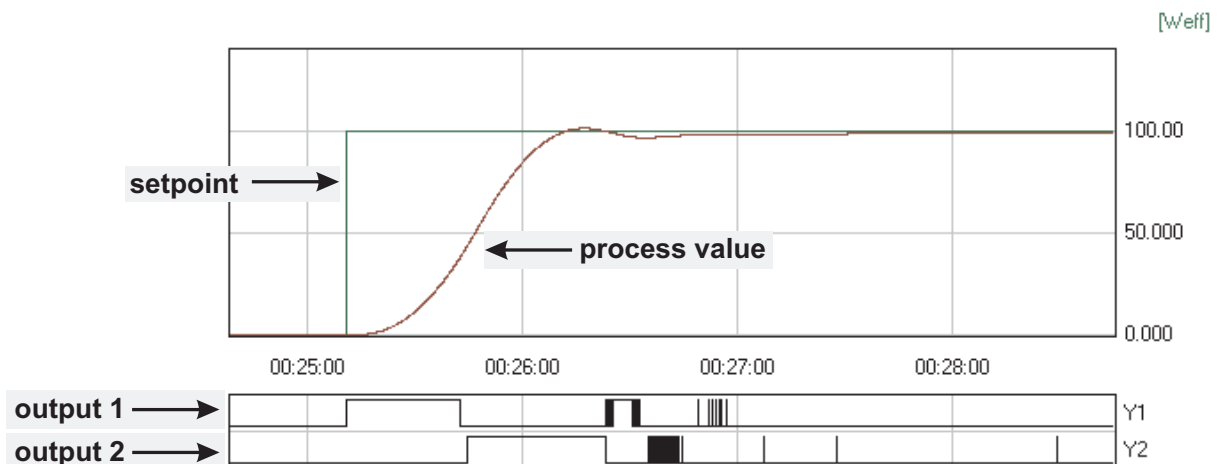

## 4.5.5 Continuous controller (inverse)

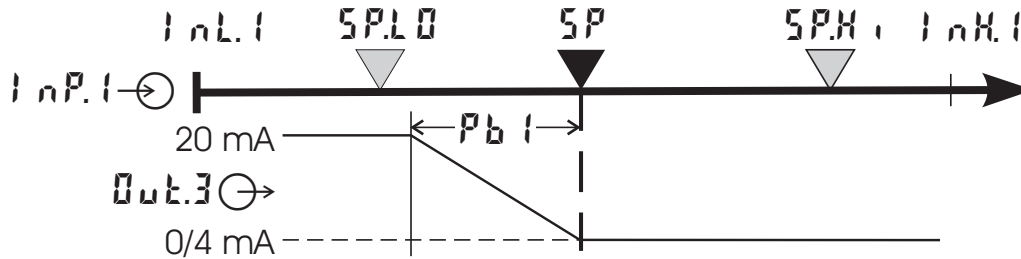

<code>CONF / ENTR:</code>	<code>SPFN</code>	<code>= 0</code>	set-point controller
	<code>CFNC</code>	<code>= 1</code>	continuous controller (PID)
	<code>CACT</code>	<code>= 0</code>	inverse action (e.g. heating applications)
<code>CONF / OUT.3:</code>	<code>OUTYP</code>	<code>= 1/2</code>	<code>OUT.3</code> type ( 0/4 ... 20mA )
	<code>OUT.0</code>	<code>= -1999...9999</code>	scaling analog output 0/4mA
	<code>OUT.1</code>	<code>= -1999...9999</code>	scaling analog output 20mA
<code>PARA / ENTR:</code>	<code>PB1</code>	<code>= 1...9999</code>	proportional band 1 (heating) in units of phys. quantity (e.g. °C)
	<code>ti1</code>	<code>= 0,1...9999</code>	integral time 1 (heating) in sec.
	<code>td1</code>	<code>= 0,1...9999</code>	derivative time 1 (heating) in sec.
	<code>t1</code>	<code>= 0,4...9999</code>	min. cycle time 1 (heating)
<code>PARA / SEtP:</code>	<code>SP.L0</code>	<code>= -1999...9999</code>	set-point limit low for Weff
	<code>SP.H0</code>	<code>= -1999...9999</code>	set-point limit high for Weff

- i** For direct action of the continuous controller, the controller action must be changed (`CONF / ENTR / CACT = 1`).
- i** To prevent control outputs `OUT.1` and `OUT.2` of the continuous controller from switching simultaneously, the control function of outputs `OUT.1` and `OUT.2` must be switched off (`CONF / OUT.1` and `OUT.2 / Y.1` and `Y.2 = 0`).



4.5.6  $\Delta$  - Y - Off controller / 2-point controller with pre-contact

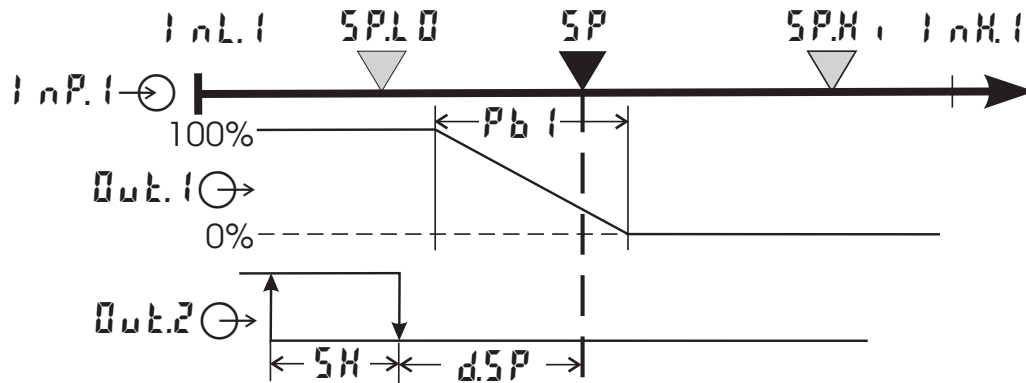

CONF / CONTR:	SPFn	= 0	set-point controller
	CFnc	= 2	$\Delta$ -Y-Off controller
	CRct	= 0	inverse action (e.g. heating applications)
CONF / Out.1:	ORct	= 0	action Out.1 direct
	Y.1	= 1	control output Y1 active
	Y.2	= 0	control output Y2 not active
CONF / Out.2:	ORct	= 0	action Out.2 direct
	Y.1	= 0	control output Y1 not active
	Y.2	= 1	control output Y2 active
PARA / CONTR:	Pb1	= 1...9999	proportional band 1 (heating) in units of phys. quantity (e.g. °C)
	t.i.1	= 0,1...9999	integral time 1 (heating) in sec.
	t.d.1	= 0,1...9999	derivative time 1 (heating) in sec.
	t.1	= 0,4...9999	min. cycle time 1 (heating)
	SH	= 0...9999	switching difference
	d.SP	= -1999...9999	trigg. point separation suppl. cont. $\Delta$ / Y / Off in units of phys. quantity
PARA / SEtP:	SPLO	= -1999...9999	set-point limit low for Weff
	SPH.1	= -1999...9999	set-point limit high for Weff

4.5.7 8800 process controller with measured value output

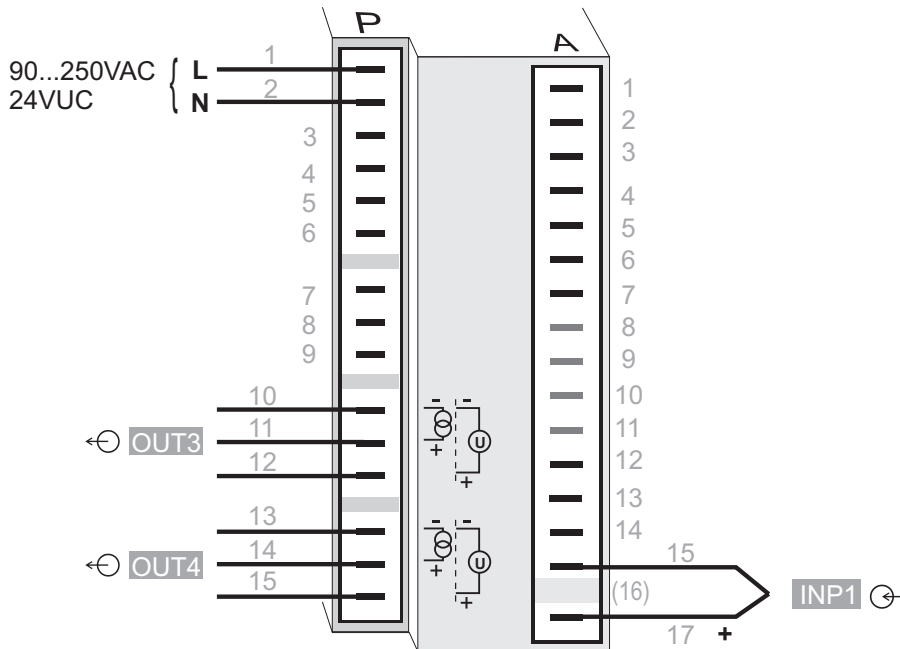
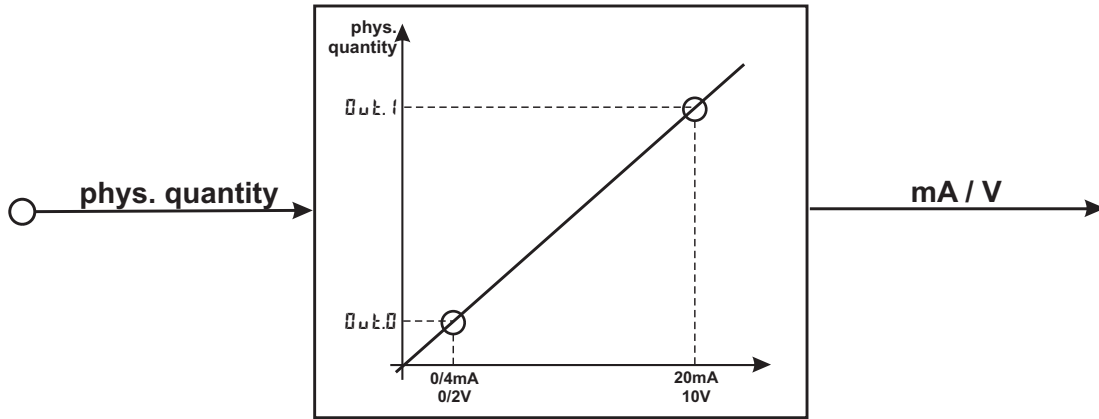

Conf / Out.3 / 4:	Out.3/4 = 1	Out.3/4 0...20mA continuous
	= 2	Out.3/4 4...20mA continuous
	= 3	Out.3/4 0...10V continuous
	= 4	Out.3/4 2...10V continuous
Out.0 =	-1999...9999	scaling Out.3/4
		for 0/4mA or 0/2V
Out.1 =	-1999...9999	scaling Out.3/4
		for 20mA or 10V
Out.2 =	3	signal source for Out.3/4 is
		the process value

4.5.8 Continuous controller with integrated positioner (CONF/ENTR = 6)

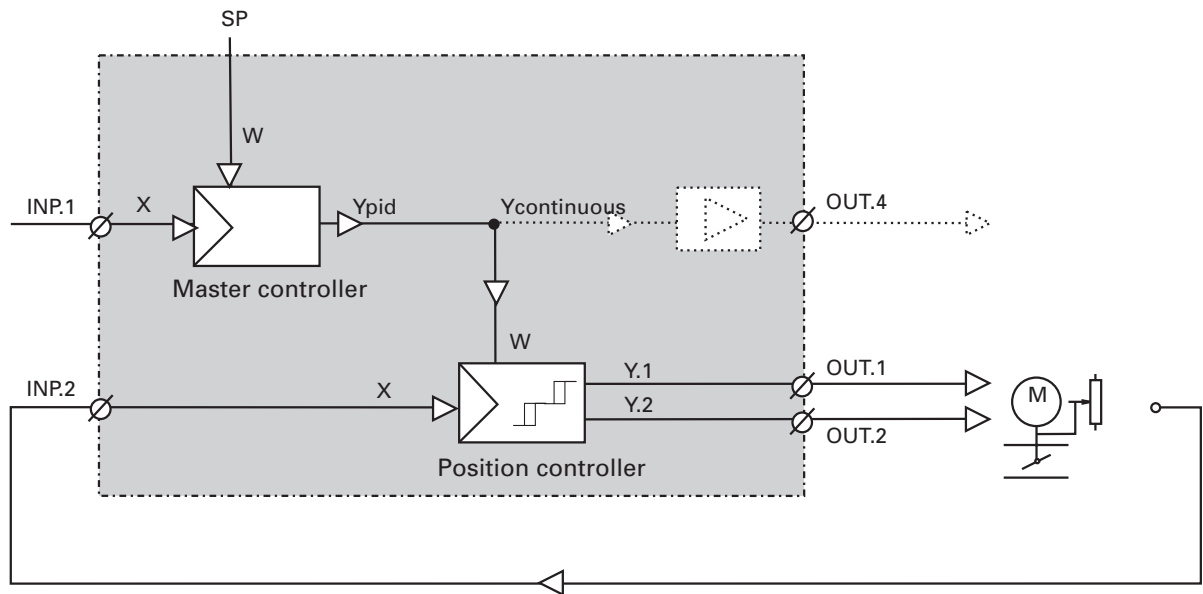

This is basically a cascade. A tracking controller with three-point stepping behaviour which operates with Yp as process value (INP.2 / INP.3) is used with the continuous controller.



CONF / ENTR	SPFN = 0	Setpoint controller
	CFNC = 6	Continuous controller with integrated positioner
	CRCT = 0	Direction of operation invers (e.g. heating)
CONF / INP.2:	IFNC = 3	Position feedback Yp
	SEYP = 50	Sensor e.g. potentiometer 0..160 Ω
CONF / OUT.1:	ORCT = 0	Direction of operation OUT.1 direct
	Y.1 = 1	Controller output Y1 activ
	Y.2 = 0	Controller output Y2 not activ
CONF / OUT.2:	ORCT = 0	Direction of operation OUT.2 direct
	Y.1 = 0	Controller output Y1 not activ
	Y.2 = 1	Controller output Y2 activ
PARA / ENTR:	Pb1 = 0,1...9999	Proportional band 1 (heating) in phys. units (e.g. °C)
	t i 1 = 1...9999	Integral action time 1 (heating) in sec.
	t d 1 = 1...9999	Derivative action time t 1 (heating) in sec.
	t 1 = 0,4...9999	Minimal cycle time 1 (heating)
	SN = 0...9999	Neutral zone in phys. units (e.g. °C)

**5** Parameter setting level

**5.1** Parameter survey

PARR Parameter setting level								
	Enter Control and self-tuning	PARR.2 2. set of parameters	SETP Set-point and process value	Input 1	Input 2	Input 3	Limit value functions	End
	LnP.1	LnP.2	LnP.3	LnL.1	LnL.2	LnL.3	LnH.1	LnH.2
△	Pb1	Pb12	SPLo	LnL.1	LnL.2	LnL.3	L.1	
▽	Pb2	Pb22	SPHi	LnL.1	LnL.2	LnL.3	H.1	
	t.1	t.12	SP.2	LnH.1	LnH.2	LnH.3	HYS.1	
	t.2	t.22	r.SP	LnH.1	LnH.2	LnH.3	dEL.1	
	td1	td12		tF.1	tF.2	tF.3	L.2	
	td2	td22		E.t.c		E.t.c	H.2	
	t.1						HYS.2	
	t.2						dEL.2	
	SH						L.3	
	HYS.L						H.3	
	HYS.H						HYS.3	
	dSP						dEL.3	
	tP						HCL.R	
	t.t							
	YL0							
	YH.1							
	Y2							
	Y0							
	Yn.H							
	LYn							
	EM20							
	t.on							
	t.off							
	FM2							
	oFFS							
	tE.nP							

**Adjustment:**

- The parameters can be adjusted by means of keys  
- Transition to the next parameter is by pressing key 
- After the last parameter of a group, **done** is displayed, followed by automatic change to the next group.



**Return to the beginning of a group is by pressing the  key for 3 sec. If for 30 sec. no keypress is executed the controller returns to the process value and setpoint display ( Time Out = 30 sec. )**

## 5.2 Parameters

### Ctrl

Name	Value range	Description	Default
Pb1	1...9999 ①	Proportional band 1 (heating) in phys. dimensions (e.g. °C)	100
Pb2	1...9999 ①	Proportional band 2 (cooling) in phys. dimensions (e.g. °C)	100
t11	0,1...9999	Integral action time 1 (heating) [s]	180
t12	0,1...9999	Integral action time 2 (cooling) [s]	180
td1	0,1...9999	Derivative action time 1 (heating) [s]	180
td2	0,1...9999	Derivative action time 2 (cooling) [s]	180
t1	0,4...9999	Minimal cycle time 1 (heating) [s]. The minimum impulse is 1/4 x t1	10
t2	0,4...9999	Minimal cycle time 2 (heating) [s]. The minimum impulse is 1/4 x t2	10
SH	0...9999	Neutral zone or switching differential for on-off control [phys. dimensions]	2
HYSL	0...9999	Switching difference Low signaller [engineering unit]	1
HYSH	0...9999	Switching difference High signaller [engineering unit]	1
dSP	-1999...9999	Trigger point separation for additional contact Δ / Y / Off [phys. dimensions]	100
tP	0,1...9999	Minimum impulse [s]	OFF
tE	3...9999	Motor travel time [s]	60
y2	-100...100	2. correcting variable	0
YL0	-120...120	Lower output limit [%]	0
YH1	-120...120	Upper output limit [%]	100
y2	-100...100	2. correcting variable	0
y0	-100...100	Working point for the correcting variable [%]	0
Ym	-100...100	Limitation of the mean value Ym [%]	5
LYm	0...9999	Max. deviation xw at the start of mean value calculation [phys. dimensions]	8
EX20	-1999...9999	Min. temperature for water cooling. Below the set temperature no water cooling happens	0
t.on	0,1...9999	Impulse length for water cooling. Fixed for all values of controller output. The pause time is varied.	1
t.off	1...9999	Min. pause time for water cooling. The max. effective controller output results from $t.on / (t.on + t.off) \cdot 100\%$	10
FX20	0,1...9999	Modification of the (non-linear) water cooling characteristic (see page 50)	1
oFFS	-120...120	Zero offset	0
tEaP	0...9999	Sensor temperature (in engineering units e.g. °C) With oxygen measurement (O <sub>2</sub> ) (see page 70)	750

① Valid for  $CONF / othr / dP = 0$ . With  $dP = 1 / 2 / 3$  also 0,1 / 0,01 / 0,001 is possible.

## PAR.2

Name	Value range	Description	Default
Pb12	1...9999 ①	Proportional band 1 (heating) in phys. dimensions (e.g. °C), 2. parameter set	100
Pb22	1...9999 ①	Proportional band 2 (cooling) in phys. dimensions (e.g. °C), 2. parameter set	100
t.22	0,1...9999	Integral action time 2 (cooling) [s], 2. parameter set	180
t.12	0,1...9999	Integral action time 1 (heating) [s], 2. parameter set	180
td12	0,1...9999	Derivative action time 1 (heating) [s], 2. parameter set	180
td22	0,1...9999	Derivative action time 2 (cooling) [s], 2. parameter set	180

## SELP

Name	Value range	Description	Default
SPLO	-1999...9999	Set-point limit low for Weff	-100
SPH.1	-1999...9999	Set-point limit high for Weff	1200
SP.2	-1999...9999	Set-point 2.	0
r.SP	0...9999	Set-point gradient [/min]	OFF
SP	-1999...9999	Set-point (only visible with 8800/8840 configurator!)	0

SPLO and SPH.1 should be within the limits of r.nGH and r.nGL see configuration → Controller page17

## INP.1

Name	Value range	Description	Default
INL.1	-1999...9999	Input value for the lower scaling point	0
OUT.1	-1999...9999	Displayed value for the lower scaling point	0
INH.1	-1999...9999	Input value for the upper scaling point	20
OUH.1	-1999...9999	Displayed value for the lower scaling point	20
t.F.1	0,0...9999	Filter time constant [s]	0,5
Ext.c.1	0...100 (°C) 32...212 (°F)	External cold-junction reference temperature (external TC)	OFF

## INP.2

Name	Value range	Description	Default
INL.2	-1999...9999	Input value for the lower scaling point	0
OUT.2	-1999...9999	Displayed value for the lower scaling point	0
INH.2	-1999...9999	Input value for the upper scaling point	50
OUH.2	-1999...9999	Displayed value for the upper scaling point	50

① Valid for Conf / otkr / dP = 0. With dP = 1 / 2 / 3 also 0,1 / 0,01 / 0,001 is possible.

Name	Value range	Description	Default
LF2	0,0...999,9	Filter time constant [s]	0,5

### INP.3

Name	Value range	Description	Default
INL3	-1999...9999	Input value for the lower scaling point	0
OUTL3	-1999...9999	Displayed value for the lower scaling point	0
INH3	-1999...9999	Input value for the upper scaling point	20
OUTH3	-1999...9999	Displayed value for the upper scaling point	20
LF3	0,0...999,9	Filter time constant [s]	0,5
EXTC3	0...100 (°C) 32...212 (°F)	External cold-junction reference temperature (external TC)	OFF

### LIM

Name	Value range	Description	Default
L1	-1999...9999	Lower limit 1	-10
H1	-1999...9999	Upper limit 1	10
HYS1	0...9999	Hysteresis limit 1	1
DEL1	0...9999	Alarm delay from limit value 1	0
L2	-1999...9999	Lower limit 2	OFF
H2	-1999...9999	Upper limit 2	OFF
HYS2	0...9999	Hysteresis limit 2	1
DEL2	0...9999	Alarm delay from limit value 2	0
L3	-1999...9999	Lower limit 3	OFF
H3	-1999...9999	Upper limit 3	OFF
HYS3	0...9999	Hysteresis limit 3	1
DEL3	0...9999	Alarm delay from limit value 3	0



**Resetting the controller configuration to factory setting (Default)**  
→ chapter 11.1 (page 82)

## 5.3 Input scaling

When using current, voltage or resistance signals as input variables for  $I_{nP.1}$ ,  $I_{nP.2}$  or/and  $I_{nP.3}$  scaling of input and display values at parameter setting level is required. Specification of the input value for lower and higher scaling point is in the relevant electrical unit (mA / V /  $\Omega$ ).

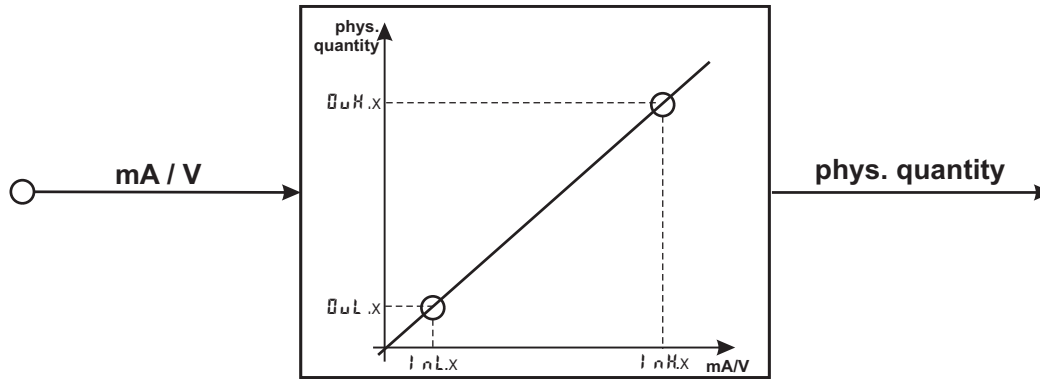

### 5.3.1 Input $I_{nP.1}$ and $I_{nP.3}$

**i** Parameters  $I_{nL.x}$ ,  $Q_{uL.x}$ ,  $I_{nH.x}$  and  $Q_{uH.x}$  are only visible if  $CONF / I_{nP.x} / CORR = 3$  is chosen.

SETP	Input signal	$I_{nL.x}$	$Q_{uL.x}$	$I_{nH.x}$	$Q_{uH.x}$
30 (0...20mA)	0 ... 20 mA	0	any	20	any
	4 ... 20 mA	4	any	20	any
40 (0...10V)	0 ... 10 V	0	any	10	any
	2 ... 10 V	2	any	10	any

In addition to these settings,  $I_{nL.x}$  and  $I_{nH.x}$  can be adjusted in the range (0...20mA / 0...10V /  $\Omega$ ) determined by selection of **SETP**.

**!** For using the predetermined scaling with thermocouple and resistance thermometer (Pt100), the settings for  $I_{nL.x}$  and  $Q_{uL.x}$  and for  $I_{nH.x}$  and  $Q_{uH.x}$  must have the same value.

**i** Input scaling changes at calibration level ( $\rightarrow$  page 65) are displayed by input scaling at parameter setting level. After calibration reset (**OFF**), the scaling parameters are reset to default.

### 5.3.2 Input $I_{nP.2}$

SETP	Input signal	$I_{nL.2}$	$Q_{uL.2}$	$I_{nH.2}$	$Q_{uH.2}$
30	0 ... 20 mA	0	any	20	any
31	0 ... 50 mA	0	any	50	any

In addition to these settings,  $I_{nL.2}$  and  $I_{nH.2}$  can be adjusted in the range (0...20/ 50mA/ $\Omega$ ) determined by selection of **SETP**.



**6 Calibration level**

Measured value correction ( $\text{CAL}$ ) is only visible if  $\text{CONF} / \text{INP.1} / \text{CORR} = 1$  or  $2$  is chosen.

The measured value can be matched in the calibration menu ( $\text{CAL}$ ). Two methods are available:

**Offset correction**

( $\text{CONF} / \text{INP.1} / \text{CORR} = 1$ ):

- possible on-line at the process

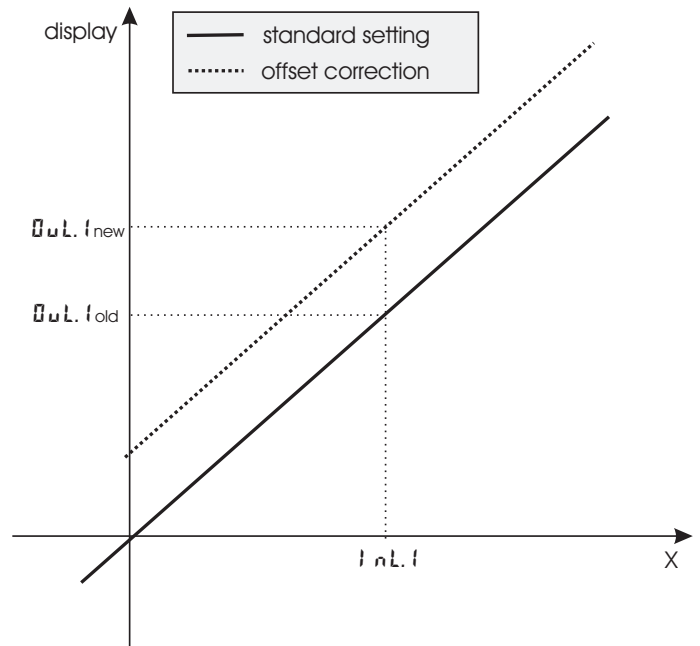

**2-point correction**



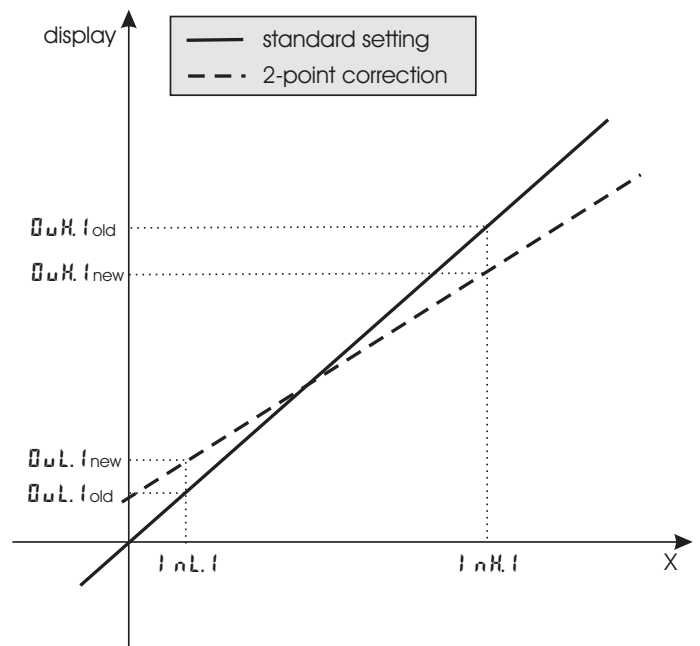

( $\text{CONF} / \text{INP.1} / \text{CORR} = 2$ ):

- is possible off-line with process value simulator

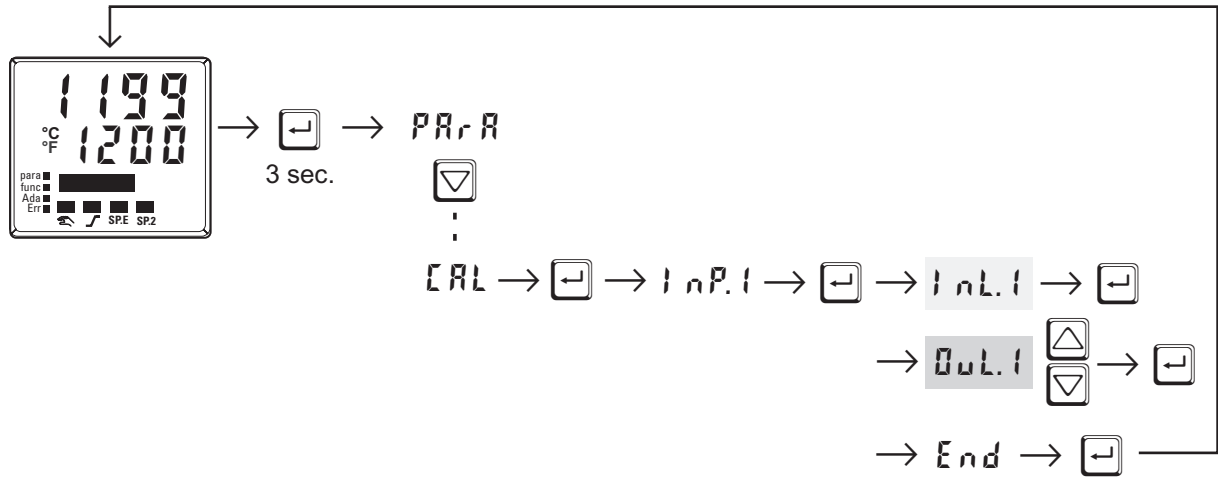

*Offset correction (CONF/INP.1/Corr = 1):*



- INL.1:** The input value of the scaling point is displayed.  
The operator must wait, until the process is at rest.  
Subsequently, the operator acknowledges the input value by pressing key .
- OVL.1:** The display value of the scaling point is displayed.  
Before calibration, **OVL.1** is equal to **INL.1**.  
The operator can correct the display value by pressing keys .  
Subsequently, he confirms the display value by pressing key .

2-point correction (CONF / InP.1 / Corr = 2):

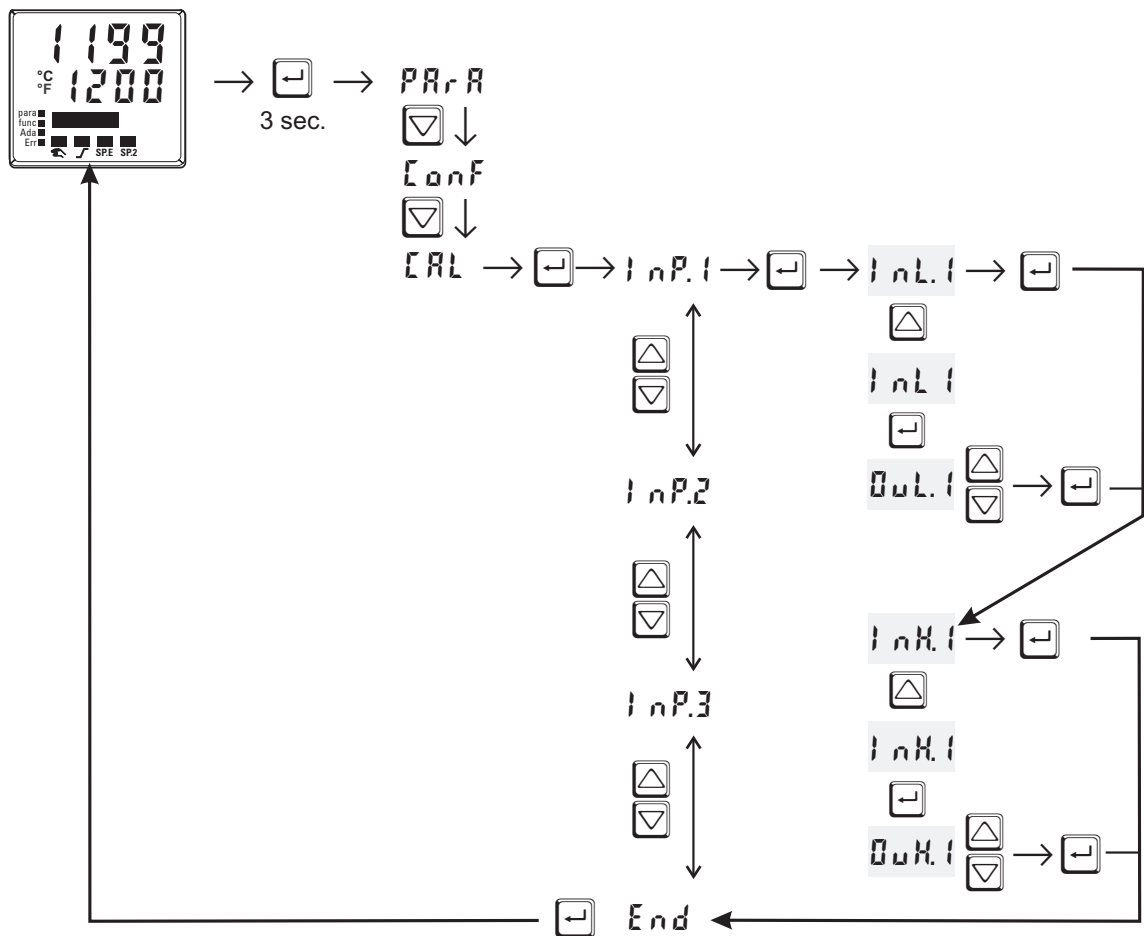

- InL.1:** The input value of the lower scaling point is displayed.  
The operator must adjust the lower input value by means of a process value simulator and confirm the input value by pressing key .
- Out.L.1:** The display value of the lower scaling point is displayed.  
Before calibration, **Out.L.1** equals **InL.1**.  
The operator can correct the lower display value by pressing the keys. Subsequently, he confirms the display value by pressing key .
- InH.1:** The input value of the upper scaling point is displayed. .  
The operator must adjust the upper input value by means of the process value simulator and confirm the input value by pressing key .
- Out.H.1:** The display value of the upper scaling point is displayed.  
Before calibration **Out.H.1** equals **InH.1**.  
The operator can correct the upper display value by pressing keys Subsequently, he confirms the display value by pressing key .

The parameters (**Out.L.1**, **Out.H.1**) changed at **CAL** level can be reset by adjusting the parameters below the lowest adjustment value (**OFF**) by means of decrement key .

## 7 Special functions

### 7.1 DAC<sup>®</sup> – motor actuator monitoring (Digital Actor Control DAC<sup>®</sup>)

With all controllers with position feedback  $Y_p$ , the motor actuator can be monitored for functional troubles. The DAC<sup>®</sup> function can be started by choosing the parameter  $CONF = 5$  or  $6$  at the configuration level ( $CONF$ ):

- $CONF / ENTER / CONF = 5$  3-point-stepping controller with position feedback  $Y_p$  as potentiometer
- $CONF / ENTER / CONF = 6$  Continuous controller with integrated positioner and position feedback  $Y_p$  as potentiometer

If an error occurs, the controller switches to manual operation (👁 - LED blinks) and no impulses are given out any longer. If one of the relays switches when a DAC<sup>®</sup> error occurs, parameter  $DRCA = 1$  and inverse action  $ORCT = 1$  must be selected for the relevant output  $OUT.1 \dots OUT.4$  in the  $CONF$  menu ( $OUT.3$  and  $4$  only possible if  $OUTYP = 0$  [relay/logic]):

- $CONF / OUT.x / DRCA = 1$  Motor actuator monitoring (DAC) active

The system detects the following stepping controller errors:

- defective motor
- defective capacitor (wrong rotating direction)
- wrong phase followers (wrong rotating direction)
- defective force transmission at spindle or drive
- excessive backlash due to wear
- jamming of the control valve e.g. due to foreign body

In these cases the controller will change to manual operation and the outputs will be switched off. Is the controller switched to automatic operation again or any modification is done the controller activates the DAC function again and the outputs will be setted.

#### *Resetting of a DAC error:*

After solving the technical problem the DAC error can be acknowledged in the error list. Thereafter the controller works again in normal operation mode.

See also chapter 3.4 "Maintenance manager / Error list", page 12 ff.

## Functioning of the DAC function

No input filter should be defined for the Yp input ( $PARR / I n P.x / L.F x = 0$ ). Therewith no wrong detection of blocking or wrong method of operation can be recognized.

The automatic calibration can be used with drives outfitted with spring assembly.

### Execution of the calibration:

It is controlled if the mean alteration between two measurements is enough for the DAC monitoring. The calibration will be stopped if the alteration between two measurements is too small.

The position of 0% is searched. Therefor the drive will be closed until there is no changing of the input signal for 0,5 sec.

Assuming that the drive is outfitted with spring assembly, the drive is opened for 2,8 sec. The drive should then still be within the spring assembly. This position is allocated and stored as 0%.

With the same procedure the position for 100% is allocated and stored.



Simultaneously the motor running time is determined and saved as parameter  $t t$ . Afterwards the controller sets the drive in the position before calibration.

Was the controller in automatic mode before calibration it will be set to automatic mode again otherwise it remains in manual mode.

### The following errors can be occur during calibration:

- the change of the Yp input is too small, no monitoring is possible
- the motion is in wrong direction
- the Yp input is broken

In these cases the automatic calibration will be stopped and the controller remains in manual mode.

-  If the automatic calibration leads to no reasonable results the calibration of the Yp input can be done manual.
-  If the controller reaches the positions of 0% or 100% the outputs will be switched off. Also in manual mode it is not possible to exceed these limits.
-  **Because no controller with continuous output and Yp input is defined there won't be the DAC function for this controlling type.**



## 7.2 O<sub>2</sub> measurement

This function is available only on the instrument version with INP3.

As the O<sub>2</sub>-measurement result range can extend over many decades, automatic display switch-over between “ % ” and “ppm“ was realized.



The instantaneous unit is displayed in the lower line.

With set-point changing via keys  or , the unit of the set-point and of the other parameters is displayed.

Lambda probes ( $\lambda$  probes) are used as sensors.

The electromotive force (in Volts) generated by  $\lambda$  probes is dependent of instantaneous oxygen content and temperature. Therefore, the 8800 process controller can only evaluate exact measurement results, if it knows the sensor temperature.

Distinction of heated and non-heated lambda probes is made. Both can be evaluated by the 8800 process controller.

### Heated lambda probes

Controlled heating which ensures constant temperature is integrated in the heated  $\lambda$  probe. This temperature must be entered in the 8800 process controller parameter Probe temperature.

Parameter → Controller → Probe temperature → .....°C (/°F - dependent of configuration)

Enter → temp.	0...9999
---------------	----------

### Non-heated lambda probes

With the probe always operated at a fixed, known temperature, a procedure as used for a heated probe can be used.

A non-heated  $\lambda$  probe is used, unless the temperature is constant. In this case, the probe temperature in addition to the probe mV value must be measured. For this purpose, any temperature measurement with one of the analog inputs INP2 or INP3 can be used. During function selection, the input must be set to X2 (second process value).

### 7.2.1 Connection

Connect the input for the lambda probe to INP1.

Use terminals A15 and A17.

If necessary, temperature measurement must be connected to INP2 or INP3.

## 7.2.2 Configuration:

### Oxygen measurement

Oxygen measurement with **heated** lambda probe

Controller → Process value processing → 7: O<sub>2</sub> functions with constant probe temperature

Ctrlr → Etyp	7	O2-const
--------------	---	----------

Oxygen measurement with **non-heated** lambda probe

Controller → Process value processing → O<sub>2</sub> functions with measured probe temperature

Ctrlr → Etyp	8	O2+temp
--------------	---	---------

Input 1 → Function INP1 → 7: process value X1

inp.1 → Func	7	X1-Input
--------------	---	----------

In **input 1**, the sensor type is set for one of the high-impedance voltage inputs:

Input 1 → Sensor type → 42: special (-25...1150 mV) or

41: special (-2,5...115 mV)

inp.1 → Etyp	41	115 mV
inp.1 → Etyp	42	1150 mV

Input 1 → meas. value correction → 0: no correction

inp.1 → Slin	0	no
--------------	---	----

### Temperature measurement (required with non-heated lambda probe)

Any temperature measurement with one of analog inputs INP2 or INP3 can be used. Select input X2 during function selection (second set-point).

-  With O<sub>2</sub> measurement, evaluation in ppm or % must be specified for all parameters related to the process value. This is done centrally during configuration.

Other → Parameter unit for O<sub>2</sub> → 0: parameter for O<sub>2</sub> function in ppm

1: parameter for O<sub>2</sub> function in %

o2hr → O2	0	unit : ppm
o2hr → O2	1	unit : %

-  Whether the temperature of the non-heated λ probe is specified in °C or °F can be selected during configuration.

Other → Unit → 1: in Celsius

2: in Fahrenheit

o2hr → Unit	1	°C
o2hr → Unit	2	°F

### 7.3 Linearization

Linearization for inputs INP1 or INP3

Access to table "L n" is always with selection of sensor type S.TYP = 18: special thermocouple in INP1 or INP3, or with selection of linearization 5.1 n 1: special linearization.

Dependent of input type, the input signals are specified in  $\mu\text{V}$  or in Ohm dependent of input type.

With up to 16 segment points, non-linear signals can be simulated or linearized. Every segment point comprises an input ( $I_{n.1} \dots I_{n.16}$ ) and an output ( $O_{u.1} \dots O_{u.16}$ ). These segment points are interconnected automatically by means of straight lines. The straight line between the first two segments is extended downwards and the straight line between the two largest segments is extended upwards. I.e. a defined output value is also provided for each input value.

When switching an  $I_{n.x}$  value to OFF, all other ones are switched off.

Condition for these configuration parameters is an ascending order.

$I_{n.1} < I_{n.2} < \dots < I_{n.16}$  and  $O_{u.1} < O_{u.2} \dots < O_{u.16}$ .

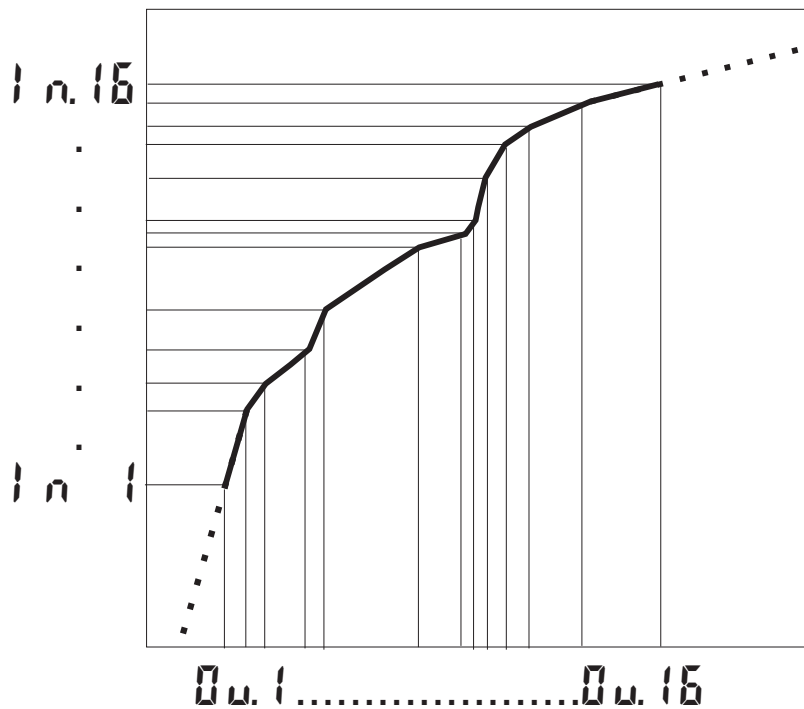



## 7.4 8800 process controller as Modbus master



This function is only selectable with 8800/8840 configurator (engineering tool)!

**Additions `obj`** (only visible with 8800/8840 configurator!)

Name	Value range	Description	Default
MASt		<b>Controller is used as Modbus master</b>	0
	0	Slave	
	1	Master	
Cycl	0...200	Cycle time [ms] for the Modbus master to transmit its data to the bus.	60
AdrO	1...65535	Target address to which the with <b>AdrU</b> specified data is given out on the bus.	1
AdrU	1...65535	Modbus address of the data that Modbus master gives to the bus.	1
Numb	0...100	Number of data that should be transmitted by the Modbus master.	0

The 8800 process controller can be used as Modbus master ( `CONF / obj / MASt = 1` ). The Modbus master sends its data to all slaves (Broadcast message, controller address 0). It transmits its data (modbus address **AdrU**) cyclic with the cycle time **Cycl** to the bus. The slave controller receives the data transmitted by the masters and allocates it to the modbus target address **AdrO**. If more than one data should be transmitted by the master controller ( `Numb > 1` ), the modbus address **AdrU** indicates the start address of the data that should be transmitted and **AdrO** indicates the first target address where the received data should be stored. The following data will be stored at the logically following modbus target addresses.

With this it is possible e.g. to specify the process value of the master controller as set-point for the slave controllers.

## 8 8800/8840 configurator

8800/8840 configurator is the projection environment for the controller series of West. The following 3 versions with graded functionality are available:

Functionality	Mini	Basic	Expert
parameter and configuration setting	yes	yes	yes
controller and control loop simulation	yes	yes	yes
download: writes an engineering to the controller	yes	yes	yes
online mode/ visualisation	SIM only	yes	yes
creation of user defined linearizations	yes	yes	yes
configuration of extended operating level	yes	yes	yes
upload: reads an engineering from the controller	SIM only	yes	yes
diagnosis function	no	no	yes
file, save engineering data	no	yes	yes
printer function	no	yes	yes
online documentation, help system	yes	yes	yes
measurement correction (calibration procedure)	yes	yes	yes
program editor	no	no	yes
data acquisition and trend function	SIM only	yes	yes
network and multiuser licence	no	no	yes
personal assistant function	yes	yes	yes
extended simulation	no	no	yes

The mini version is - free of charge - at your disposal as download at West homepage [www.westinstruments.com](http://www.westinstruments.com) or on the West-CD (please ask for).

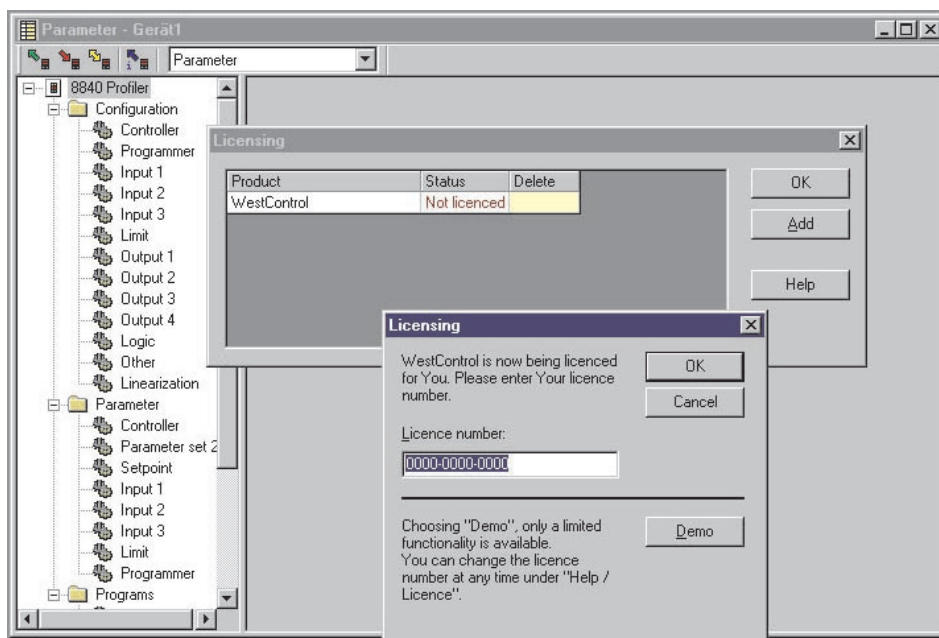

At the end of the installation the licence number has to be stated or DEMO mode must be chosen. At DEMO mode the licence number can be stated subsequently under **Help** → **Licence** → **Change**.

**9 Versions**

	8	8	0	0	1			0			00
Flat-pin connectors					0						
Screw terminals					1						
90..250V AC, 4 relays					0						
24VAC / 18..30VDC, 4 relays					1						
90..250V AC, 3 relays + mA/logic					2						
24VAC / 18..30VDC, 3 relays +mA/logic					3						
90..250V AC, 2 relays + 2xmA/logic					4						
24VAC / 18..30VDC, 2 relays + 2xmA/logic					5						
no option					0						
RS422/485 + U <sub>T</sub> + di2, di3 + OUT5, OUT6					1						
PROFIBUS-DP + U <sub>T</sub> + di2/di3 + OUT5/OUT6					2						
INP1 and INP2					0						
INP1, INP2 and INP3 incl. O <sub>2</sub> measuring					1						
Standard configuration								0			
Configuration to specification								9			
no manual									0		
manual german									D		
manual english									E		
manual french									F		
Standard										0	
UL certified										U	
DIN 3440 certified										D	
Unit/f ront according to customer specification											XX

**Accessories delivered with the unit**

Operating manual (if selected by the ordering code)

- 2 fixing clamps
- operating note in 12 languages

**Accessory equipment with ordering information**

Description	Order no.
Heating current transformer 50A AC	9404-407-50001
PC-adaptor for the front-panel interface	9407-998-00001
Standard rail adaptor	Insert order-no.
Operating manual	German 9499-040-70718
Operating manual	English 9499-040-70711
Operating manual	French 9499-040-70732
Interface description Modbus RTU	German 9499-040-70818
Interface description Modbus RTU	English 9499-040-70811
Interface description Profibus	German 9499-040-70918
Interface description Profibus	English 9499-040-70911
8800/8840 configurator (engineering tool)	Mini Download www.westinstruments.com
8800/8840 configurator (engineering tool)	Basic Insert order-no.
8800/8840 configurator (engineering tool)	Expert Insert order-no.

## 10 Technical data

### INPUTS

#### PROCESS VALUE INPUT INP1

Resolution:	> 14 bits
Decimal point:	0 to 3 digits behind the decimal point
Dig. input filter:	adjustable 0,000...9999 s
Scanning cycle:	100 ms
Measured value correction:	2-point or offset correction

#### Thermocouples

→ Table 1 (page 80 )

Input resistance:	$\geq 1 \text{ M}\Omega$
Effect of source resistance:	$1 \mu\text{V}/\Omega$

#### Cold-junction compensation

Maximal additional error:	$\pm 0,5 \text{ K}$
---------------------------	---------------------

#### Sensor break monitoring

Sensor current:	$\leq 1 \mu\text{A}$
Configurable output action	

#### Resistance thermometer

→ Table 2 (page 80 )

Connection:	3-wire
Lead resistance:	max. 30 Ohm
Input circuit monitor:	break and short circuit

#### Special measuring range

8800/8840 Configurator (engineering tool) can be used to match the input to sensor KTY 11-6 (characteristic is stored in the controller).

Physical measuring range:	0...4500 Ohm
Linearization segments	16

#### Current and voltage signals

→ Table 3 (page 80 )

Span start, end of span:	anywhere within measuring range
Scaling:	selectable -1999...9999

Linearization:	16 segments, adaptable with 8800/8840 Configurator
Decimal point:	adjustable
Input circuit monitor:	12,5% below span start (2mA, 1V)

#### SUPPLEMENTARY INPUT INP2

Resolution:	> 14 bits
Scanning cycle:	100 ms

#### Heating current measurement

via current transformer (→ Accessory equipment)

Measuring range:	0...50mA AC
Scaling:	adjustable -1999...0,000...9999 A

#### Current measuring range

Technical data as for INP1

#### Potentiometer

→ Table 2 (page 80 )

#### SUPPLEMENTARY INPUT INP3 (OPTION)

Resolution:	> 14 bits
Scanning cycle:	100 ms

Technical data as for INP1 except 10V range.

#### CONTROL INPUTS DI1, DI2

Configurable as switch or push-button!  
Connection of a potential-free contact suitable for switching "dry" circuits.

Switched voltage:	5 V
Current:	100 $\mu\text{A}$

**CONTROL INPUTS DI2, DI3 (OPTION)**

The digital input di2 located on the A-card and di2 located on the option card are or-linked. Configurable as switch or push-button! Optocoupler input for active triggering.

Nominal voltage	24 V DC external
Current sink (IEC 1131 type 1)	
Logic "0"	-3...5 V
Logic "1"	15...30 V
Current requirement	approx.. 5 mA

**TRANSMITTER SUPPLY U<sub>T</sub> (OPTION)**

Power: 22 mA / ≥ 18 V

If the universal output OUT3 or OUT4 is used there may be no external galvanic connection between measuring and output circuits!

**GALVANIC ISOLATION**

- Safety isolation
- == Function isolation

Mains supply	Process value input INP1 Supplementary input INP2 Optional input INP3 Digital input di1, di2
Relay OUT1	RS422/485 interface
Relay OUT2	Digital inputs di2, 3
Relay OUT3	Universal output OUT3
Relay OUT4	Universal output OUT4
	Transmitter supply U <sub>T</sub> OUT5, OUT6

**OUTPUTS**

**RELAY OUTPUTS OUT1...OUT4**

Contact type:	potential-free changeover contact
Max.contact rating:	500 VA, 250 V, 2A at 48...62 Hz, resistive load
Min. contact rating:	5V, 10 mA AC/DC

Operating life (electr.): 600.000 duty cycles with max. contact rating

**Note:**

If the relays operate external contactors, these must be fitted with RC snubber circuits to manufacturer specifications to prevent excessive switch-off voltage peaks.

**OUT3, 4 AS UNIVERSAL OUTPUT**

Galvanically isolated from the inputs.  
Freely scalable resolution: 11 bits

**Current output**

0/4...20 mA configurable.	
Signal range:	0...approx.22mA
Max. load:	≤ 500 Ω
Load effect:	no effect
Resolution:	≤ 22 μA (0,1%)
Accuracy	≤ 40 μA (0,2%)

**Voltage output**

0/2...10V configurable	
Signal range:	0...11 V
Min. load:	≥ 2 kΩ
Load effect:	no effect
Resolution:	≤ 11 mV (0,1%)
Accuracy	≤ 20 mV (0,2%)

**OUT3, 4 used as transmitter supply**

Output power: 22 mA / ≥ 13 V

**OUT3, 4 used as logic output**

Load ≤ 500 Ω	0/≤ 20 mA
Load > 500 Ω	0/> 13 V

**OUTPUTS OUT5/6 (OPTION)**

Galvanically isolated opto-coupler outputs. Grounded load: common positive voltage. Output rating: 18...32 VDC; ≤ 70 mA Internal voltage drop: ≤ 1 V with I<sub>max</sub> Protective circuit: built-in against short circuit, overload, reversed polarity (free-wheel diode for relay loads).

## Technical data

---

### **POWER SUPPLY**

---

Dependent of order:

### **AC SUPPLY**

Voltage: 90...260 V AC  
Frequency: 48...62 Hz  
Power consumption approx. 7,0 VA

### **UNIVERSAL SUPPLY 24 V UC**

AC voltage: 20,4...26,4 V AC  
Frequency: 48...62 Hz  
DC voltage: 18...31 V DC  
Power consumption: approx.. 7,0 VA

### **BEHAVIOUR WITH POWER FAILURE**

*Configuration, parameters and adjusted set-points, control mode:*

Non-volatile storage in EEPROM

### **FRONT INTERFACE**

---

Connection of PC via PC adapter (see "Accessory equipment"). The 8800/8840 Configurator software is used to configure, set parameters and operate the 8840 profiler.

### **BUS INTERFACE (OPTION)**

---

Galvanically isolated  
Physical: RS 422/485  
Protocol: Modbus RTU  
Transmission speed: 2400, 4800, 9600, 19.200 bits/sec  
Address range: 1...247  
Number of controllers per bus: 32

Repeaters must be used to connect a higher number of controllers.

### **ENVIRONMENTAL CONDITIONS**

---

#### **Protection modes**

Front panel: IP 65 (NEMA 4X)  
Housing: IP 20  
Terminals: IP 00

### **Permissible temperatures**

For specified accuracy: 0...60°C  
Warm-up time: ≥ 15 minutes  
For operation: -20...65°C  
For storage: -40...70°C

### **Humidity**

75% yearly average, no condensation

### **Shock and vibration**

#### **Vibration test Fc (DIN 68-2-6)**

Frequency: 10...150 Hz  
Unit in operation: 1g or 0,075 mm  
Unit not in operation: 2g or 0,15 mm

#### **Shock test Ea (DIN IEC 68-2-27)**

Shock: 15g  
Duration: 11ms

### **Electromagnetic compatibility**

Complies with EN 61 326-1  
(for continuous, non-attended operation)

### **GENERAL**

---

#### **Housing**

Material: Makrolon 9415  
flame-retardant  
Flammability class: UL 94 VO, self-extinguishing  
Plug-in module, inserted from the front

#### **Safety test**

Complies with EN 61010-1 (VDE 0411-1):  
Overvoltage category II  
Contamination class 2  
Working voltage range 300 V  
Protection class II

## **Certifications**

*UL-approval*

## **Electrical connections**

- flat-pin terminals 1 x 6,3mm or 2 x 2,8mm to DIN 46 244 or
- screw terminals for 0,5 to 2,5mm<sup>2</sup>

## **Mounting**

Panel mounting with two fixing clamps at top/bottom or right/left,  
High-density mounting possible

Mounting position: uncritical

Weight: 0,27kg

## **Accessories delivered with the unit**

Operating manual

Fixing clamps

## Technical data

Table 1 Thermocouples measuring ranges

Thermoelementtype		Measuring range		Accuracy	Resolution (∅)
L	Fe-CuNi (DIN)	-100...900°C	-148...1652°F	≤ 2K	0,1 K
J	Fe-CuNi	-100...1200°C	-148...2192°F	≤ 2K	0,1 K
K	NiCr-Ni	-100...1350°C	-148...2462°F	≤ 2K	0,2 K
N	Nicrosil/Nisil	-100...1300°C	-148...2372°F	≤ 2K	0,2 K
S	PtRh-Pt 10%	0...1760°C	32...3200°F	≤ 2K	0,2 K
R	PtRh-Pt 13%	0...1760°C	32...3200°F	≤ 2K	0,2 K
T	Cu-CuNi	-200...400°C	-328...752°F	≤ 2K	0,05 K
C	W5%Re-W26%Re	0...2315°C	32...4199°F	≤ 2K	0,4 K
D	W3%Re-W25%Re	0...2315°C	32...4199°F	≤ 2K	0,4 K
E	NiCr-CuNi	-100...1000°C	-148...1832°F	≤ 2K	0,1 K
B*	PtRh-Pt6%	0(100)...1820°C	32(212)...3308°F	≤ 2K	0,3 K

\* Specifications valid for 400°C

Table 2 Resistance transducer measuring ranges

Type	Signal Current	Measuring range		Accuracy	Resolution (∅)
Pt100	0,2mA	-200...100°C	-140...212°F	≤ 1K	0,1K
Pt100		-200...850°C	-140...1562°F	≤ 1K	0,1K
Pt1000		-200...850°C	-140...392°F	≤ 2K	0,1K
KTY 11-6 *		-50...150°C	-58...302°F	≤ 2K	0,05K
Spezial		0...4500		≤ 0,02 %	0,01 %
Spezial		0...450			
Poti		0...160			
Poti		0...450			
Poti		0...1600			
Poti		0...4500			

\* Or special

Table 3 Current and voltage measuring ranges

Measuring range	Input impedance	Accuracy	Resolution (∅)
0-10 Volt	≈ 110 kΩ	≤ 0,1 %	0,6 mV
-2,5-115 mV	≥ 1MΩ	≤ 0,1 %	6 μV
-25-1150 mV	≥ 1MΩ	≤ 0,1 %	60 μV
0-20 mA	20 Ω	≤ 0,1 %	1,5 μA



## 11 Safety hints

This unit was built and tested in compliance with VDE 0411-1 / EN 61010-1 and was delivered in safe condition.

The unit complies with European guideline 89/336/EEG (EMC) and is provided with CE marking.

The unit was tested before delivery and has passed the tests required by the test schedule. To maintain this condition and to ensure safe operation, the user must follow the hints and warnings given in this operating manual.

The unit is intended exclusively for use as a measurement and control instrument in technical installations.



### **Warning**

If the unit is damaged to an extent that safe operation seems impossible, the unit must not be taken into operation.

### **ELECTRICAL CONNECTIONS**

The electrical wiring must conform to local standards (e.g. VDE 0100). The input measurement and control leads must be kept separate from signal and power supply leads.

In the installation of the controller a switch or a circuit-breaker must be used and signified. The switch or circuit-breaker must be installed near by the controller and the user must have easy access to the controller.

### **COMMISSIONING**

Before instrument switch-on, check that the following information is taken into account:

- Ensure that the supply voltage corresponds to the specifications on the type label.
- All covers required for contact protection must be fitted.
- If the controller is connected with other units in the same signal loop, check that the equipment in the output circuit is not affected before switch-on. If necessary, suitable protective measures must be taken.
- The unit may be operated only in installed condition.
- Before and during operation, the temperature restrictions specified for controller operation must be met.

### **SHUT-DOWN**

For taking the unit out of operation, disconnect it from all voltage sources and protect it against accidental operation.

If the controller is connected with other equipment in the same signal loop, check that other equipment in the output circuit is not affected before switch-off. If necessary, suitable protective measures must be taken.

### MAINTENANCE, REPAIR AND MODIFICATION

The units do not need particular maintenance.



#### Warning

When opening the units, or when removing covers or components, live parts and terminals may be exposed.

**Before starting this work, the unit must be disconnected completely.**

After completing this work, re-shut the unit and re-fit all covers and components. Check if specifications on the type label must be changed and correct them, if necessary.



#### Caution

When opening the units, components which are sensitive to electrostatic discharge (ESD) can be exposed. The following work may be done only at workstations with suitable ESD protection.

Modification, maintenance and repair work may be done only by trained and authorized personnel. For this purpose, the West service should be contacted.



The cleaning of the front of the controller should be done with a dry or a wetted (spirit, water) kerchief.

---

## 11.1 *Resetting to factory setting*

---

In case of faulty configuration, 8800 process controller can be reset to the default condition.

For this, keep the following two keys pressed during power-on :



Controller reset to default is signalled by displaying **FACtory** shortly in the display. Subsequently, the controller returns to normal operation.



**12** Notes





## Index

<b>0-9</b>		Digital inputs di1, di2, di3	
2-point correction. . . . .	67	Configuration . . . . .	44
<b>A</b>		Technical data . . . . .	78
Alarm handling . . . . .	28 - 29	<b>E</b>	
<b>B</b>		Environmental conditions . . . . .	81
Bargraph . . . . .	12	Equipment . . . . .	77
Bus interface		Error list . . . . .	15
Technical Data. . . . .	81	<b>F</b>	
<b>C</b>		Front view . . . . .	12
Calibration level (EFL) . . . . .	67 - 69	<b>I</b>	
Certifications . . . . .	82	Input INP1	
Configuration examples		Configuration . . . . .	33
2-point controller . . . . .	55	Parameters . . . . .	64
3-point controller . . . . .	56	Technical data . . . . .	78
3-point stepping controller . . . . .	57	Input INP2	
Continuous controller . . . . .	58	Configuration . . . . .	35
D - Y -Off controller. . . . .	59	Parameters . . . . .	64
Measured value output . . . . .	60	Technical data . . . . .	78
Signaller . . . . .	54	Input INP3	
Configuration level		Configuration . . . . .	35
Configuration parameters. . . . .	32 - 49	Parameters . . . . .	65
Parameter survey . . . . .	31	Technical data . . . . .	78
Connecting diagram . . . . .	7	Input scaling . . . . .	66
Connecting examples		<b>L</b>	
di2/3, 2-wire transmitter supply . . . . .	9	LED	
INP2 current transformer . . . . .	8	Ada - LED . . . . .	12
OUT1/2 heating/cooling . . . . .	8	Err - LED . . . . .	12
OUT3 as logic output . . . . .	11	func - LED. . . . .	12
OUT3 transmitter supply . . . . .	10	↵ - LED. . . . .	12
RS485 interface . . . . .	10	LED colours . . . . .	12
Control inputs di1, di2, di3		☞ - LED. . . . .	12
Technical data . . . . .	78	para - LED. . . . .	12
Cooling functions		SP.2 - LED. . . . .	12
Constant period . . . . .	53	SP.E - LED . . . . .	12
Standard . . . . .	51	Linearisierung . . . . .	74
Water cooling non-linear . . . . .	52	<b>M</b>	
Current signal measuring range . . . . .	78	Maintenance manager . . . . .	15 - 17
<b>D</b>		Manual tuning . . . . .	26
DAC . . . . .	70 - 71	Modbus master . . . . .	75
		Mounting. . . . .	6
		<b>N</b>	
		Notes. . . . .	86 - 87

<b>O</b>	
O2-Messung . . . . .	72
Offset correction . . . . .	67
Optimierung am Sollwert . . . . .	20
Output OUT1	
Configuration . . . . .	39
Technical data . . . . .	79
Output OUT2	
Configuration . . . . .	40
Technical data . . . . .	79
Output OUT3	
Configuration . . . . .	41
Technical data . . . . .	79
Output OUT4	
Configuration . . . . .	42
Technical data . . . . .	79
Output OUT5	
Configuration . . . . .	44
Technical data . . . . .	80
Output OUT6	
Configuration . . . . .	44
Technical data . . . . .	80

<b>P</b>	
Parameter setting level	
Parameter survey . . . . .	62
Parameters . . . . .	63 - 65
Parameter Sollwertgradient . . . . .	64

<b>R</b>	
Resetting to factory setting. . . . .	85
Resistance thermometer measuring range . . . . .	78

<b>S</b>	
Safety hints . . . . .	84 - 85
Safety switch. . . . .	6
Safety test. . . . .	81
Sauerstoffmessung . . . . .	72
Self-tuning	
Cancelation . . . . .	23
Cancelation causes. . . . .	24
Set-point processing . . . . .	50

<b>T</b>	
Thermocouple measuring range . . . . .	78

<b>V</b>	
Versions . . . . .	77
Voltage signal measuring range . . . . .	78

---

Subject to alterations without notice

**West Instruments**

Printed in Germany 9499-040-70611 (08/2003)

**A6**

---