



# $\frac{1}{8}$ -DIN DIGITAL INDICATOR PRODUCT MANUAL

59039-2

# PREFACE

This manual comprises two volumes:

- Volume I: This supports normal operation of the  $\frac{1}{8}$ -DIN Digital Indicator. In normal operation, all actions taken by the user are to be in front of the panel.
- Volume II: This supports the installation, commissioning and configuring of the  $\frac{1}{8}$ -DIN Digital Indicator. *It is intended for use only by personnel who are trained, equipped and authorised to carry out these functions.*



**CAUTION: REFER TO MANUAL**

THE INTERNATIONAL HAZARD SYMBOL IS INSCRIBED ADJACENT TO THE REAR CONNECTION TERMINALS. IT IS IMPORTANT TO READ THE MANUAL BEFORE INSTALLING OR COMMISSIONING THE UNIT.

$\frac{1}{8}$ -DIN DIGITAL INDICATOR  
PRODUCT MANUAL  
VOLUME I  
OPERATING INSTRUCTIONS

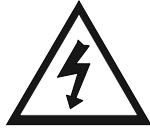

In normal operation, the operator must not remove the Indicator from its housing or have unrestricted access to the rear terminals, as this would provide potential contact with hazardous live parts.

Installation and configuration *must be undertaken by technically competent servicing personnel*. This is covered in Volume II of this manual.

## **Contents**

1	INTRODUCTION	1-1
2	OPERATOR MODE	2-1
3	SET UP MODE	3-1
4	RS485 SERIAL COMMUNICATIONS	4-1

## **Appendices**

A	Alphabetical Index	A-1
---	--------------------	-----

## SECTION 1 INTRODUCTION



*Showing Degrees Centigrade*



*With Customer-selected Units Display*

The  $\frac{1}{8}$ -DIN Digital Indicator is an easy-to-operate microprocessor-based instrument, incorporating the latest in surface-mount and CMOS technology. The standard features include:

- \* Large four-digit LED display (orderable as red or green).
- \* Display for units indication
- \* Universal sensor input - thermocouple, three-wire RTD or DC linear (mA, mV or V)
- \* Input range selected from the front panel.
- \* Alarm 1 latching or non-latching (user-selectable) relay output
- \* Alarm hysteresis
- \* Maximum Hold, Minimum Hold and Time Elapsed features.

- \* 90 - 264V AC power supply.
- \* Designed to comply with EN50081 Part 2 (Emission) and EN50082 (Immunity) EMC specifications.
- \* Front panel sealing to IP65 (NEMA 4) standard.
- \* Programmable digital filter.
- \* Process Variable offset facility
- \* Alarm type selected from front panel.
- \* Sensor Break indication.

and the many optional features include:

- \* Alarm 2 and Alarm 3 relay outputs
- \* Remote reset of latched alarm
- \* Re-transmitted Process Variable output
- \* Transmitter power supply
- \* ASCII and MODBUS communications protocols
- \* RS485 serial communications.

## SECTION 2

### OPERATOR MODE

#### 2.1 INTRODUCTION

The Operator Mode is the normal mode of the Indicator, once it has been set up and configured as required. The front panel displays, indicators and keys are shown in Figure 2-1.

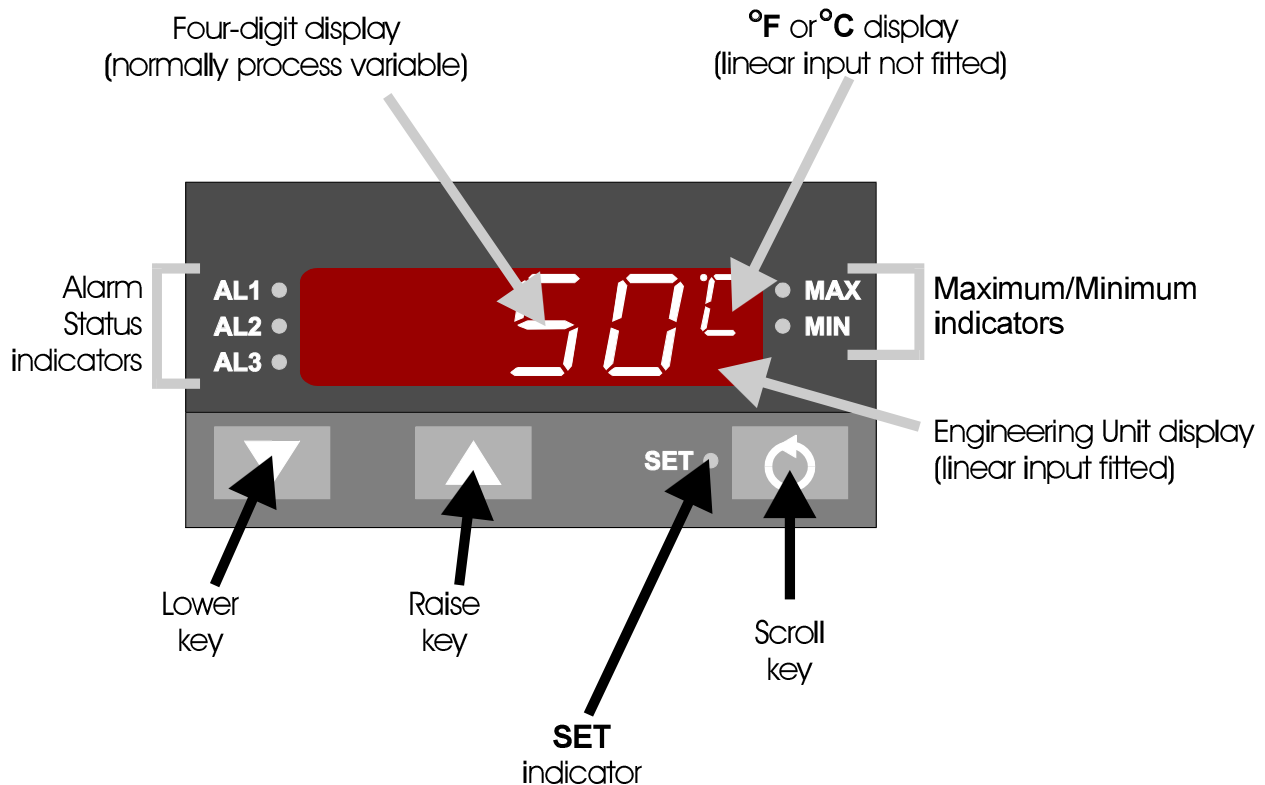

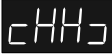

Figure 2-1 Front Panel Controls, Displays and Indicators

#### 2.2 FOUR-DIGIT DISPLAY

In Operator Mode, this normally displays the process variable value. Using the Scroll key, the operator may view, in a sequence according to the Operator Mode Display Strategy parameter in Set Up Mode (see NOTES ON TABLE 3-1):

- (i) Current maximum value attained by process variable (since the maximum value was last reset) - **MAX** indicator ON when this is displayed. Also saves the Sensor Break (see Subsection 2.6) and Over-Range (see Subsection 2.5) conditions.
- (ii) Current minimum value attained by process variable (since the minimum value was last reset) - **MIN** indicator ON when this is displayed. Also saves the Sensor Break (see Subsection 2.6) and Under-Range (see Subsection 2.5) conditions.

(iii) Time elapsed in the Alarm 1 active condition (units display shows  ). The display is in the format mm.ss [mm = minutes, ss = seconds] or mmm.s [mmm = minutes, s = seconds (tens)]. If elapsed time is greater than 999 minutes 59 seconds, display will show: 

NOTE: This does not include time when Alarm 1 is latched but alarm condition is cleared

(iv) Alarm 1 value (units display shows  or, if only Alarm 1 present,  ).

(v) Alarm 2 value, if fitted and configured (units display shows  ).

(vi) Alarm 3 value, if fitted and configured (units display shows  ).

(iv) Process variable value.

Further depressions of the Scroll key will repeat this display sequence.

### 2.3 ALARM STATUS INDICATORS

The Alarm Status indicators show the current state of the alarm(s):

- AL1** - Flashes when Alarm 1 is active (with latching alarm, ON when Alarm 1 is latched but alarm condition has cleared)
- AL2** - Flashes when Alarm 2 is active
- AL3** - Flashes when Alarm 3 is active

For descriptions of the operation of the various types of alarm available, see Section 3.

### 2.4 RESETTING THE MAXIMUM VALUE/MINIMUM VALUE OR TIME ELAPSED VALUE

To reset the maximum value, minimum value (to the process variable value at the instant of resetting) or time elapsed value (to zero):

1. Select the display of the maximum value, minimum value or time elapsed value (as appropriate - see above).
2. Depress the Raise key or Lower key for three seconds.

The resetting of the value is indicated by the four-digit display showing:



for two seconds before reverting to the maximum value or minimum value display.



## 2.5 OVER-RANGE/UNDER-RANGE DISPLAYS

If the process variable attains a value higher than the input scale maximum limit (over-range) or lower than the input scale minimum limit (under-range), the upper display will show:



for the over-range condition and:



for the under-range condition.

## 2.6 SENSOR BREAK INDICATION

If a break is detected in the sensor circuit, the four-digit display will show:



The reaction of the alarms to a detected sensor break is dependent upon the input type.

## 2.7 COLD JUNCTION COMPENSATION DISABLED

If a thermocouple input is fitted, the Cold Junction Compensation should be enabled. If it is disabled, whenever the process variable is displayed, the unit display will be as shown on the right.



## 2.8 RESETTING THE LATCHED ALARM

If Output 1 is configured to be a latched alarm output, once it becomes active it will remain active (even if the alarm condition itself is cleared) until reset either from the front panel or via the Remote Reset hardware option. To reset the latched alarm from the front panel:

1. Ensure that the normal Operating Mode display (i.e. process variable) is shown.
2. Press either the Raise key or the Lower key for at least three seconds.

The four-digit display will then show:



for two seconds, indicating that the latched alarm has been reset. *The latched Alarm 1 can be reset only if the original alarm condition has been cleared; this reset has no effect whilst the alarm condition prevails.*

## 2.9 VIEWING THE HARDWARE DEFINITION CODE

The operator may view the current Hardware Definition Code setting in the four-digit display by simultaneously depressing the Lower and Scroll keys. A return may be made to the normal Operator Mode display by simultaneously depressing the Lower and Scroll keys.

NOTE: An automatic return is made to the normal Operator Mode display after 30 seconds.

To view the Hardware Option setting, press the Scroll key whilst the Hardware Definition Code is displayed. To return to the Hardware Definition Code display, depress the Lower and Scroll keys simultaneously.

## SECTION 3

### SET UP MODE

#### 3.1 ENTRY INTO SET UP MODE

To enter Set Up Mode, with the instrument initially in Operator Mode displaying the process variable value, depress the Raise and Scroll keys simultaneously for three seconds. The instrument will then enter Set Up Mode and the **SET** indicator will come ON, the instrument still displaying the process variable value.















NOTE: If the four-digit display shows:





(i.e. all decimal point positions illuminated), this indicates that one or more of the critical Configuration Mode parameters - typically input range - have been altered in value/setting and, as a consequence, all Set Up Mode parameters have been automatically set to their default values/settings. To clear this display, simply alter the value/setting of any Set Up Mode parameter (see below).

The parameters available for view/adjustment in Set Up Mode are summarised in Table 3-1. When Set Up Mode is active, the units display (normally °F, °C or blank) will show the single-character legend for the selected parameter and the value for that parameter will be shown in the four-digit display. The user may step through the Set Up Mode parameters by depressing the Scroll key. The value/setting may be altered using the Raise/Lower keys.

Table 3-1 Set Up Parameters

Parameter	Legend	Adjustment Range	Default
Alarm 1 Value <sup>1</sup>	 or 	Range Min. to Range Max.	Range Max. (Proc. High) Range Min. (Proc. Low)
Alarm 1 Hysteresis		1 LSD to 10% of span expressed as display units	1 LSD
Alarm 2 Value <sup>2</sup>		Range Min. to Range Max.	Range Max. (Proc. High) Range Min. (Proc. Low)
Alarm 2 Hysteresis <sup>2</sup>		1 LSD to 10% of span expressed as display units	1 LSD
Alarm 3 Value <sup>3</sup>		Range Min. to Range Max.	Range Max. (Proc. High) Range Min. (Proc. Low)
Alarm 3 Hysteresis <sup>3</sup>		1 LSD to 10% of span expressed as display units	1 LSD
Process Variable Offset		(input span of instrument	0
Digital Filter Time Const.		0.0 secs. (OFF) to 100.0 secs. in 0.5 sec. increments.	2.0 secs.
Linear Input Decimal Point Position <sup>4</sup>		0 (XXXX), 1 (XXX.X), 2 (XX.XX) or 3 (X.XXX)	1
Linear Input Scale Range Minimum <sup>4</sup>		-1999 to 9999	0000
Linear Input Scale Range Maximum <sup>4</sup>		-1999 to 9999	1000
Recorder Output Scale Minimum		-1999 to 9999	Range Min.
Recorder Output Scale Maximum		-1999 to 9999	Range Max.
Operator Mode Display Strategy <sup>5</sup>		0, 1, 2, 3 or 4	0

**NOTES ON TABLE 3-1**

1. The legend for this parameter will be  if only Alarm 1 is fitted/configured or  if other alarms are fitted/configured.
2. These parameters appear in the display sequence only if Alarm 2 is fitted/configured.
3. These parameters appear in the display sequence only if Alarm 3 is fitted/configured.
4. Only applicable if a DC Linear input is fitted.
5. Defines the parameters displayed in sequence in Operator Mode:

Parameter Setting				
0	1	2	3	4
PV value	PV value	PV value	PV value	PV value
Max. PV value	Max. PV value	Alarm 1 value	Max. PV value	Max. PV value
Min. PV value	Min. PV value	Alarm 2 value *	Min. PV value	Min. PV value
Elapsed Time		Alarm 3 value *	Alarm 1 value	Elapsed Time
			Alarm 2 value *	Alarm 1 value
			Alarm 3 value *	Alarm 2 value *
				Alarm 3 value

\* If configured/fitted

**3.2 ALARM 1 VALUE**



If Alarm 1 is selected to be a Process High alarm, this defines the process variable value at or above which Alarm 1 will be active; the default value will be Input Range Maximum. If Alarm 1 is selected to be a Process Low alarm, this defines the process variable value at or below which Alarm 1 will be active; the default value will be Input Range Minimum. Its value may be adjusted between Input Range Maximum and Input Range Minimum. Alarm operation is illustrated in Figure 3-1.

**3.3 ALARM 1 HYSTERESIS**



This parameter applies a hysteresis band on the “safe” side of the Alarm 1 value. The effect of the hysteresis value on alarm operation is shown in Figure 3-2.

**3.4 ALARM 2 VALUE**



If Alarm 2 is selected to be a Process High alarm, this defines the process variable value at or above which Alarm 2 will be active; the default value will be Input Range Maximum. If Alarm 2 is selected to be a Process Low alarm, this defines the process variable value at or below which Alarm 2 will be active; the default value will be Input Range Minimum. Its value may be adjusted between Input Range Maximum and Input Range Minimum. Alarm operation is illustrated in Figure 3-1.

**3.5 ALARM 2 HYSTERESIS**



This parameter applies a hysteresis band on the “safe” side of the Alarm 2 value. The effect of the hysteresis value on alarm operation is shown in Figure 3-2.

### 3.6 ALARM 3 VALUE



If Alarm 3 is selected to be a Process High alarm, this defines the process variable value at or above which Alarm 3 will be active; the default value will be Input Range Maximum. If Alarm 3 is selected to be a Process Low alarm, this defines the process variable value at or below which Alarm 3 will be active; the default value will be Input Range Minimum. Its value may be adjusted between Input Range Maximum and Input Range Minimum. Alarm operation is illustrated in Figure 3-1.

### 3.7 ALARM 3 HYSTERESIS



This parameter applies a hysteresis band on the “safe” side of the Alarm 3 value. The effect of the hysteresis value on alarm operation is shown in Figure 3-2.

### 3.8 PROCESS VARIABLE OFFSET



This parameter is used to modify the actual process variable value (measured at the input terminals) in the following manner:

$$\text{Offset PV value} = \text{Actual PV value} + \text{Process Variable Offset value.}$$

The offset process variable value is used for all PV-dependent functions (display, alarm, recorder output).

**CAUTION:** This is, in effect, a calibration adjustment. Injudicious application of values to this parameter could lead to the displayed process variable value bearing no meaningful relationship to the actual process variable value. **There is no front panel indication when this parameter is in effect (i.e. has been set to a non-zero value).**

The default value is 0.

### 3.9 INPUT FILTER TIME CONSTANT



The input is equipped with a digital filter which is used to filter out any extraneous impulses on the process variable. This filtered PV is used for all PV-dependent functions (alarms etc.). The time constant for this filter may be adjusted in the range 0.0 seconds (filter OFF) to 100.0 seconds in 0.5 second increments. The default setting is 2.0 seconds.

**CAUTION:** If this parameter is set excessively high, the indication quality may be significantly impaired. The value chosen should be sufficiently large to attenuate stray noise but no larger.

### 3.10 LINEAR INPUT SCALE RANGE MINIMUM



This parameter, applicable only if a linear input is fitted, defines the scaled input value when the process variable input is at its minimum value. It is adjustable between -1999 and 9999 (with decimal point as defined by Linear Input Decimal Point Position). The default value is 0. This parameter can be set to a value greater than (but not equal to) Linear Input Scale Range Maximum, in which case the sense of the input is reversed.

### 3.11 LINEAR INPUT SCALE RANGE MAXIMUM



This parameter, applicable only if a linear input is fitted, defines the scaled input value when the process variable input is at its maximum value. It is adjustable between -1999 and 9999 (with decimal point as defined by Linear Input Decimal Point Position). The default value is 1000. This parameter can be set to a value less than (but not equal to) Linear Input Scale Range Minimum, in which case the sense of the input is reversed.

### 3.12 RECORDER OUTPUT SCALE MINIMUM



This parameter defines the value of the process variable at which the Recorder Output reaches its minimum value; for example, for a 0 - 5V Recorder Output, this value corresponds to 0V. It may be adjusted within the range -1999 to 9999. The decimal point position for the Recorder Output is always the same as that for the process variable input range. The default value is Input Range Minimum. This parameter is not applicable if the Recorder Output option is not fitted.

NOTE: If this parameter is set to a value greater than that for the **Recorder Output Scale Maximum** (see Subsection 3.13), the relationship between the process variable value and the Recorder Output is reversed.

### 3.13 RECORDER OUTPUT SCALE MAXIMUM



This parameter defines the value of process variable at which the Recorder Output reaches its maximum value; for example, for a 0 - 5V Recorder Output, this value corresponds to 5V. It may be adjusted within the range -1999 to 9999. The decimal point position for the Recorder Output is always the same as that for the process variable input range. The default value is Input Range Maximum. This parameter is not applicable if the Recorder Output option is not fitted.

NOTE: If this parameter is set to a value less than that for the **Recorder Output Scale Minimum** (see Subsection 3.12), the relationship between the process variable/setpoint value and the Recorder Output is reversed.

### 3.14 OPERATOR MODE DISPLAY STRATEGY



This defines the sequence of parameter displays available in Operator Mode (see **NOTES ON TABLE 3-1**).

### 3.15 EXIT FROM SET UP MODE

To leave Set Up Mode, select the initial Operator Mode display (process variable value) then depress the Raise and Scroll keys simultaneously, whereupon the **SET** indicator will go OFF and the instrument will return to Operator Mode.

NOTE: An automatic return to Operator mode will be executed if there is no key activity in Set Up Mode for one minute.

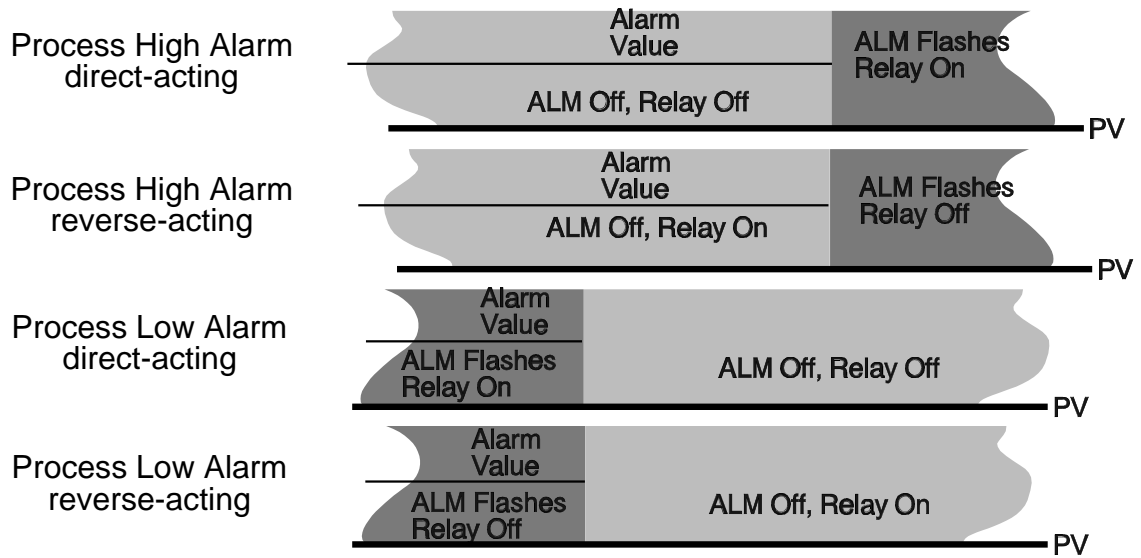

**NOTE**

The "Relay On/Off" statements apply only if the alarm is connected to an output.

Figure 3-1 Alarm Operation

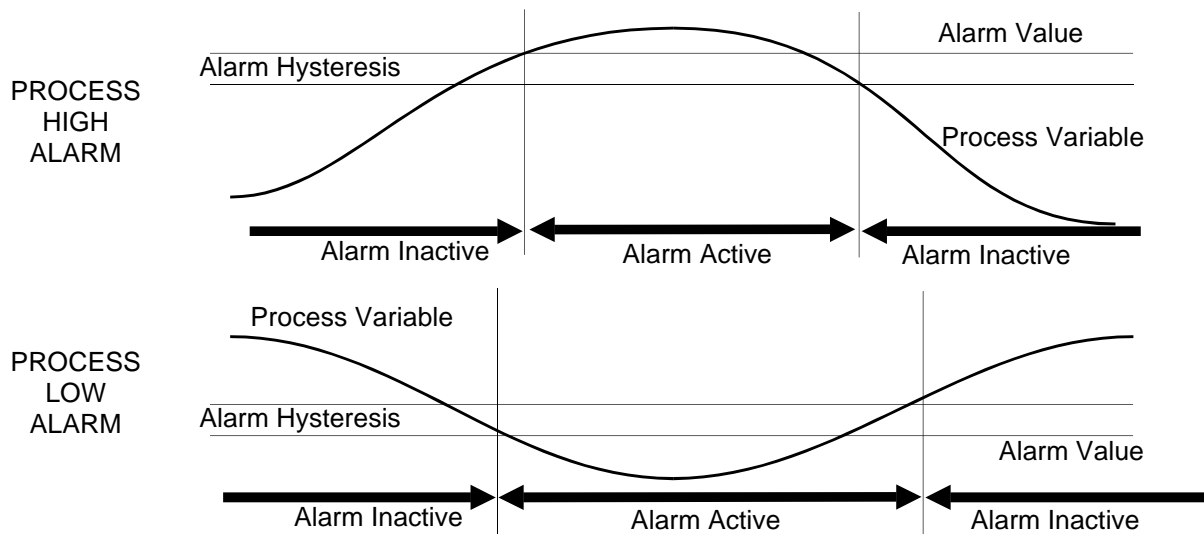

Figure 3-2 Alarm Hysteresis Operation



## SECTION 4

### RS485 SERIAL COMMUNICATIONS

This three-wire RS485-compatible serial communications option is the means by which communication may occur between the instrument and a master device (e.g. a computer or terminal).

#### 4.1 PHYSICAL REQUIREMENTS

There are two communications protocols available with this option:

- (a) ASCII
- (b) MODBUS

##### 4.1.1 Character Transmission

Data format is fixed to be seven data bits and one stop bit. The Baud rate may be selected to be 1200, 2400, 4800 (default) or 9600 Baud. For ASCII protocol, the parity is even. For MODBUS protocol, the parity is selectable to be even, odd or none.

##### 4.1.2 Line Turn-Round

**ASCII Protocol:** The communications link is operated as a multi-drop half duplex system. When a device is transmitting, it drives the transmission lines to the appropriate levels; when it is not transmitting, its outputs are set to a high impedance in order that another device can transmit. It is important that a transmitter releases the transmission lines before another device starts transmission. This imposes the following restraints on the master device:

- (a) The transmitter must release the transmission lines within 6ms of the end of the last character of a message being transmitted. Note that delays due to buffers such as those used in universal asynchronous receivers/transmitters (UARTs) within the master device must be taken into account.
- (b) The transmitter must not start transmission until 6ms has elapsed since the reception of the last character of a message.

All instruments in this range having an RS485 communications facility adhere to this standard; thus, provided that the master device conforms similarly to the standard, there should be no line contention problems.

**MODBUS Protocol:** The line turn-round timings adhere to the industry standard.

#### 4.2 ASCII PROTOCOL

This protocol assumes half duplex communications. All communication is initiated by the master device. The master sends a command or query to the addressed slave and the slave replies with an acknowledgement of the command or the reply to the query. All messages, in either direction, comprise:

- (a) A Start of Message character
- (b) One or two address characters (uniquely defining the slave)
- (c) A parameter/data character string
- (d) An End of Message character

Messages from the master device may be one of four types:

- Type 1:** L {N} ? ? \*
- Type 2:** L {N} {P} {C} \*
- Type 3:** L {N} {P} # {DATA} \*
- Type 4:** L {N} {P} I \*

where all characters are in ASCII code and:

- L is the Start of Message character (Hex 4C)
- {N} is the slave address (in the range 1 - 32); addresses 1 - 9 may be represented by a single digit (e.g. 7) or in two-digit form, the first digit being zero (e.g. 07).
- {P} is a character which identifies the parameter to be interrogated/modified - see Table 4-2.
- {C} is the command (see below)
- # indicates that {DATA} is to follow (Hex 23)
- {DATA} is a string of numerical data in ASCII code (see Table 4-1)
- \* is the End of Message character (Hex 2A)

No space characters are permitted in messages. Any syntax errors in a received message will cause the slave to issue no reply and await the Start of Message character.

Table 4-1 {DATA} Element - Sign and Decimal Point Position

{DATA} Content	Sign/Decimal Point Position
abcd0	+abcd
abcd1	+abc. d
abcd2	+ab. cd
abcd3	+a. bcd
abcd5	-abcd
abcd6	-abc. d
abcd7	-ab. cd
abcd8	-a. bcd

Table 4-2 Commands/Parameters and Identifiers

Identifier Character	Parameter/Command	Operation
A	Maximum Process Variable value	Read Only
B	Minimum Process Variable value	Read Only
C	Alarm 1 value	Read/Write
D	Alarm 1 Hysteresis value	Read/Write
E	Alarm 2 value <sup>1</sup>	Read/Write
F	Alarm 2 Hysteresis value <sup>1</sup>	Read/Write
G	Scale Range Maximum	Read/Write (linear inputs only) - otherwise Read Only
H	Scale Range Minimum	Read/Write (linear inputs only) - otherwise Read Only
J	Process Variable Offset value	Read/Write
L	Instrument Status <sup>2</sup>	Read Only
M	Process Variable value	Read Only
N	Alarm 3 value <sup>3</sup>	Read/Write
O	Alarm 3 Hysteresis <sup>3</sup>	Read/Write
Q	Scale Range Decimal Point Position	Read/Write (linear inputs only) - otherwise Read Only
T	Time Elapsed	Read Only
Z	Instrument Commands <sup>4</sup>	Write Only
[	Recorder Output Scale Maximum <sup>5</sup>	Read/Write
\	Recorder Output Scale Minimum <sup>5</sup>	Read/Write
]	Scan Table <sup>6</sup>	Read Only
m	Input Filter Time Constant value	Read/Write

### NOTES

1. Applicable only if Alarm 2 is configured.
2. See Subsection 4.3.15.
3. Applicable only if Alarm 3 is configured.
4. See Subsection 4.3.16.
5. Applicable only if Output 2 is configured as a Recorder Output.
6. See Subsection 4.3.17.

#### 4.2.1 Type 1 Message

L {N} ? ? \*

This message is used by the master device to determine whether the addressed slave is active. The reply from the slave instrument, if it is active, is

L {N} ? A \*

An inactive instrument will give no reply.

#### 4.2.2 Type 2 Message

L {N} {P} {C} \*

This type of message is used by the master device to interrogate or modify a parameter in the addressed instrument. {P} identifies the parameter (as defined in Table 4-2) and {C} represents the command to be executed, which may be one of the following:

- + (Hex 2B) - Increment the value of the parameter defined by {P}
- (Hex 2D) - Decrement the value of the parameter defined by {P}
- ? (Hex 3F) - Determine the current value of the parameter defined by {P}

The reply from the addressed instrument is of the form:

L {N} {P} {DATA} A \*

where {DATA} comprises five ASCII-coded digits whose format is shown in Table 4-1. The data is the value requested in a query message or the new value of the parameter after modification. If the action requested by the message from the master device would result in an invalid value for that parameter (either because the requested new value would be outside the permitted range for that parameter or because the parameter is not modifiable), the instrument replies with a negative acknowledgement:

L {N} {P} {DATA} N \*

The {DATA} string in the negative acknowledgement reply will be indeterminate.

### Scan Tables

A parameter identifier character "]" in the message from the master device indicates that a "Scan Table" operation is required. This provides a facility for interrogating the values of a group of parameters and status in a single message from the master device. The reply to such a command would be in the form:

L {N} ] 25 aaaaa bbbbbb ccccc ddddd eeeee A \*

The digits aaaaa, bbbbbb etc. are expressed as shown in Table 4-1. For further information, refer to Subsection 4.3.17.

#### 4.2.3 Type 3 Message

L {N} {P} # {DATA} \*

This message type is used by the master device to set a parameter to the value specified in {DATA}. The command is not implemented immediately by the slave instrument; the slave will receive this command and will then wait for a Type 4 message (see below). Upon receipt of a Type 3 message, if the {DATA} content and the specified parameter are valid, the slave reply is of the form:

$$L \{N\} \{P\} \{DATA\} I *$$

(where I = Hex 49) indicating that the instrument is ready to implement the command. If the parameter specified is invalid or is not modifiable or if the desired value is outside the permitted range for that parameter, the instrument replies with a negative acknowledgement in the form:

$$L \{N\} \{P\} \{DATA\} N *$$

#### 4.2.4 Type 4 Message

$$L \{N\} \{P\} I *$$

This type of message is sent by the master device to the addressed slave following a successful Type 3 message transmission and reply to/from the same slave instrument. Provided that the {DATA} content and the parameter specified in the preceding Type 3 message are still valid, the slave will then set the parameter to the desired value and will reply in the form:

$$L \{N\} \{P\} \{DATA\} A *$$

where {DATA} is the new value of the parameter. If the new value or parameter specified is invalid, the slave will reply with a negative acknowledgement in the form:

$$L \{N\} \{P\} \{DATA\} N *$$

where {DATA} is indeterminate. If the immediately-preceding message received by the slave was not a Type 3 message, the Type 4 message is ignored.

### 4.3 INDIVIDUAL PARAMETERS

The individual parameters and how they may be interrogated/modified are described below. Unless otherwise stated, the {DATA} element will follow the standard five-digit format and the decimal point position must be correct for the new value to be accepted and for modification to occur.

NOTE: The communications identifier character {P} for each parameter is shown to the right of each subsection heading.

#### 4.3.1 Process Variable

 $\{P\} = M$ 

This parameter may be interrogated only, using a Type 2 message. If the process variable is out of range, the five-digit {DATA} field in the reply will not contain a number, but will contain <??>0 (over-range) or <??>5 (under-range).

#### 4.3.2 Process Variable Offset

 $\{P\} = J$ 

This parameter may be modified/interrogated using a Type 2 message or a Type 3/4 message sequence. It modifies the actual process variable value (as measured at the instrument's input terminals) in the following manner:

$$\text{Modified PV value} = \text{Actual PV value} + \text{process variable offset value}$$

The modified PV value is limited by Range Maximum and Range Minimum and is used for display and alarm purposes and for recorder outputs.

NOTE: This parameter value should be selected with care. Any adjustment to this parameter is, in effect, an adjustment to the instrument's calibration. Injudicious application of values to this parameter could lead to the displayed PV value having no meaningful relationship to the actual PV value.

**4.3.3 Scale Range Maximum** {P} = G

This parameter (which is adjustable only on DC linear inputs) may be interrogated using a Type 2 message or may be modified using a Type 3/4 message sequence. The decimal point position is as for the input range.

**4.3.4 Scale Range Minimum** {P} = H

This parameter (which is adjustable only on DC linear inputs) may be interrogated using a Type 2 message or may be modified using a Type 3/4 message sequence. The decimal point position is as for the input range.

**4.3.5 Scale Range Decimal Point Position** {P} = Q

Adjustable on DC linear inputs only, this parameter may be modified/interrogated using a Type 2 message or a Type 3/4 message sequence. The value of this parameter defines the decimal point position, as follows:

Value	Decimal Point Position
0	abcd
1	abc.d
2	ab.cd
3	a.bcd

**4.3.6 Input Filter Time Constant** {P} = m

This parameter may be modified/interrogated using a Type 2 message or a Type 3/4 message sequence.

**4.3.7 Recorder Output Scale Maximum Value** {P} = [

This parameter may be modified/interrogated using a Type 2 message or a Type 3/4 message sequence. It defines the maximum scale value for the Controller's Recorder Output and may be adjusted within the range -1999 to 9999. This value corresponds to the Input Scale Maximum and the decimal point position will always be the same as that for the input.

NOTE: If this parameter is set to a value less than the Recorder Output Minimum Value, the sense of the Recorder Output is reversed.

**4.3.8 Recorder Output Scale Minimum Value** {P} = \

This parameter may be modified/interrogated using a Type 2 message or a Type 3/4 message sequence. It defines the minimum scale value for the Controller's Recorder Output and may be adjusted within the range -1999 to 9999. This value corresponds to

the Input Scale Minimum and the decimal point position will always be the same as that for the input.

NOTE: If this parameter is set to a value greater than the Recorder Output Maximum Value, the sense of the Recorder Output is reversed.

#### **4.3.9 Alarm 1 Value** {P} = C

This parameter may be modified/interrogated using a Type 2 message or a Type 3/4 message sequence. It defines the level at which Alarm 1 will go active. The decimal point position is as for the input range.

#### **4.3.10 Alarm 1 Hysteresis Value** {P} = D

This parameter may be modified/interrogated using a Type 2 message or a Type 3/4 message sequence. It defines the hysteresis band applied to the "safe" side of Alarm 1. The decimal point position is as for the input range.

#### **4.3.11 Alarm 2 Value** {P} = E

This parameter may be modified/interrogated using a Type 2 message or a Type 3/4 message sequence. It defines the level at which Alarm 2 will go active. The decimal point position is as for the input range.

#### **4.3.12 Alarm 2 Hysteresis Value** {P} = F

This parameter may be modified/interrogated using a Type 2 message or a Type 3/4 message sequence. It defines the hysteresis band applied to the "safe" side of Alarm 2. The decimal point position is as for the input range.

#### **4.3.13 Alarm 3 Value** {P} = N

This parameter may be modified/interrogated using a Type 2 message or a Type 3/4 message sequence. It defines the level at which Alarm 3 will go active. The decimal point position is as for the input range.

#### **4.3.14 Alarm 3 Hysteresis Value** {P} = O

This parameter may be modified/interrogated using a Type 2 message or a Type 3/4 message sequence. It defines the hysteresis band applied to the "safe" side of Alarm 3. The decimal point position is as for the input range.

#### **4.3.15 Instrument Status** {P} = L

This parameter may be interrogated only, using a Type 2 message. The status information is encoded in the four digits as the decimal representation of a binary number. Each bit in the binary number has a particular significance:

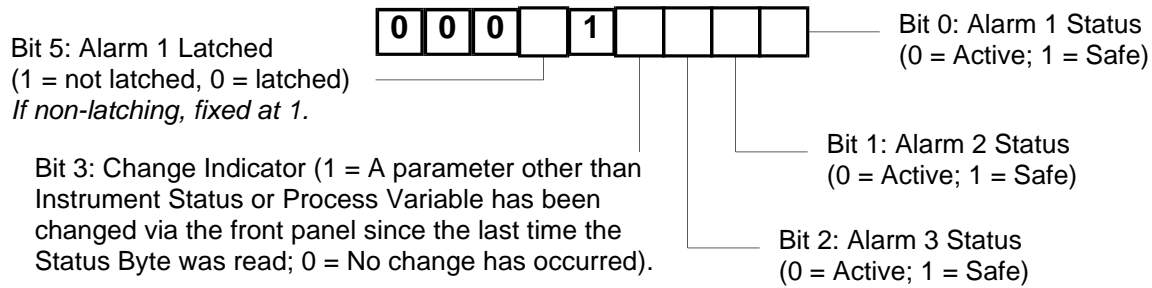

#### 4.3.16 Instrument Commands

{P} = Z

Only Type 3 or Type 4 messages are allowed with this parameter. In the Type 3 message, the {DATA} field must be one of four five-digit numbers. The reply from the instrument also contains the {DATA} field with the same content. When the master device issues the Type 4 message, the instrument responds with the same {DATA} field content. The commands corresponding to the {DATA} field value are:

- 00150 = Unlatch Alarm 1 (returns NAK if Alarm 1 is non-latching)
- 00160 = Reset Process Variable Maximum (to current PV value)
- 00170 = Reset Process Variable Minimum (to current PV value)
- 00180 = Reset Time Elapsed (to zero)

#### 4.3.17 Scan Table

{P} = ]

The Scan Table operation takes the form of a Type 2 interrogation command which accesses a set of information (held in the {DATA} element in the response). The response would be in the form:

L {N} ] 25 aaaaa bbbbbb ccccc ddddd eeeee A \*

These digits are as described in Table 4-1 and comprise:

aaaaa	The current process variable value
bbbbbb	The current maximum process variable value
ccccc	The current minimum process variable value
dddddd	The current Time Elapsed value
eeeeee	The Instrument Status (see Subsection 4.3.15).

#### 4.3.18 Error Response

The circumstances under which a message from the master device is ignored are:

- Parity error detected
- Syntax error detected
- Timeout elapsed
- Receipt of a Type 4 message without a preceding Type 3 command message.

Negative acknowledgements will be returned if, in spite of the received message being notionally correct, the instrument cannot supply the requested information or perform the requested operation. The {DATA} element of a negative acknowledgement will be indeterminate.



## 4.4 MODBUS PROTOCOL

With the RS485 Serial Communication option fitted and configured, communication between a master device and slave instruments via protocol conforming to the MODBUS industry standard is available.

NOTE: Support for multi-parameter Write operations is limited to support of the Multi-word Write Function (Number 16) but this permits writing of one parameter value only per message.

The parameter numbering system divides the parameters into bits and words, each group being numbered independently.

### 4.4.1 Bit Parameters

There are up to 11 bit parameters:

Parameter	No.	Operation	Notes
Alarm 1 Status	1	Read Only	1 = Active
Alarm 2 Status	2	Read Only	1 = Active
Alarm 3 Status	3	Read Only	1 = Active
Alarm 1 Latched	4	Read Only	1 = Alarm 1 latched *
PV Under-range Flag	5	Read Only	1 = Active
PV Over-range Flag	6	Read Only	1 = Active
Sensor Break Active	7	Read Only	1 = Active
Reset Latched Alarm	8	Write Only	
Reset PV Maximum	9	Write Only	
Reset PV Minimum	10	Write Only	
Reset Time Elapsed	11	Write Only	

\* Always returns 0 if Alarm 1 not configured to be latching.

#### 4.4.2 Word Parameters

Parameter	No.	Operation	Notes
Process Variable (PV)	1	Read Only *	
PV Maximum	2	Read Only *	
PV Minimum	3	Read Only *	
Time Elapsed	4	Read Only *	
Instrument Status	5	Read Only	
PV Offset	6	Read/Write	
Alarm 1 value	7	Read/Write	
Alarm 2 value	8	Read/Write	Only if Alarm 2 is configured
Alarm 3 value	9	Read/Write	Only if Alarm 3 is configured
Alarm 1 Hysteresis	10	Read/Write	
Alarm 2 Hysteresis	11	Read/Write	Only if Alarm 2 is configured
Alarm 3 Hysteresis	12	Read/Write	Only if Alarm 3 is configured
Filter Time Constant	13	Read/Write	
Decimal Point Position	14	Read/Write	Read Only for non-linear inputs
Scale Range Min.	15	Read/Write	Read Only for non-linear inputs
Scale Range Max.	16	Read/Write	Read Only for non-linear inputs
Recorder Output Scale Max.	17	Read/Write	Only if Recorder Output is configured
Recorder Output Scale Min.	18	Read/Write	Only if Recorder Output is configured
Manufacturer ID	121	Read Only	= 231 (representing "W1")
Equipment ID	122	Read Only	number 8010

\* When the process variable is over-range or under-range or when a sensor break condition occurs, the value returned is:

Condition	Hex.	Signed	Unsigned
Over-range	F700	-2304	63232
Under-range	F600	-2560	62976
Sensor Break condition	F800	-2048	63488

The PV Max. parameter will return the Over-range value or Sensor Break value (as appropriate) if either condition has occurred since the PV Max. parameter was last reset.

The PV Min. parameter will return the Under-range value or Sensor Break value (as appropriate) if either condition has occurred since the PV Min. parameter was last reset.

The Time Elapsed parameter will return the Over-range value if the time exceeds 1000 minutes.

NOTE: All these parameters return signed values except Time Elapsed (which is unsigned) and Instrument Status (in which Bits 0 - 6 of the status byte return Bit Parameters 1 - 7 respectively - see Subsection 4.4.1)

## Alphabetical Index

### A

<b>AL1</b> Indicator	
Function	2-2
<b>AL2</b> Indicator	
Function	2-2
<b>AL3</b> Indicator	
Function	2-2
Alarm Hysteresis	
Alarm 1	3-3
Alarm 1 (adjusting - comms.)	4-7
Alarm 2	3-3
Alarm 2 (adjusting - comms.)	4-7
Alarm 3	3-4
Alarm 3 (adjusting - comms.)	4-7
Alarm Status Indicators	
Functions	2-2
Alarm Value	
Alarm 1	3-3
Alarm 1 (adjusting - comms.)	4-7
Alarm 1 Operator Mode display	2-2
Alarm 2	3-3
Alarm 2 (adjusting - comms.)	4-7
Alarm 2 Operator Mode display	2-2
Alarm 3	3-4

Alarm 3 (adjusting - comms.)  
4-7

Alarm 3 Operator Mode display  
2-2

### C

Cold Junction Compensation	
Disabled, indication of	2-3
Communications	
ASCII protocol	4-1
Baud rates	4-1
Data format	4-1
End of Message character	4-2
Line release time maximum value	4-1
Line turn-round	4-1
Message types	4-2
MODBUS bit parameters	4-9
MODBUS protocol	4-9
MODBUS word parameters	4-10
Parity (ASCII protocol)	4-1
Parity (MODBUS protocol)	4-1
Scan Tables command	4-4
Start of Message character	4-2
Type 1 message	4-4
Type 2 message	4-4
Type 3 message	4-4
Type 4 message	4-5

Communications Message Format  
 4-1

**D**

Display Strategy (Operator Mode)  
 3-5

**E**

Error Responses 4-8

**H**

Hardware Definition Code  
 Viewing in Operator Mode  
 2-4

Hardware Option  
 Viewing in Operator Mode  
 2-4

**I**

Input Filter Time Constant 3-4

Adjusting (comms.) 4-6

Input Over-range Display 2-3

Input Under-range Display 2-3

Instrument Commands 4-8

Instrument Status 4-7

**L**

Latched Alarm  
 Resetting (from front panel)  
 2-3

Resetting (via comms. link)  
 4-8

Linear Input  
 Reversing sense of 3-4 - 3-5

Scale Range Decimal Point  
 Position 4-6

Scale range maximum 3-5

Scale range maximum (adjusting  
 - comms.) 4-6

Scale range minimum 3-4

Scale range minimum (adjusting  
 - comms.) 4-6

**P**

Process Variable

Interrogating (comms.) 4-5

Operator Mode display 2-1 -  
 2-2

Process Variable Maximum

Operator Mode display 2-1

Resetting (from front panel)  
 2-2

Resetting (via comms. link)  
 4-8

Process Variable Minimum

Operator Mode display 2-1

Resetting (from front panel)  
 2-2

Resetting (via comms. link)  
 4-8

Process Variable Offset 3-4

Adjusting (comms.) 4-5

**R**

Recorder Output

Reversing sense of 3-5 - 4-7

Scale maximum 3-5

Scale Maximum Value (adjusting  
 - comms.) 4-6

Scale minimum 3-5

Scale Minimum Value (adjusting  
 - comms.) 4-6

**S**

Scan Tables Command 4-8

Sensor Break Indication

    Operator Mode 2-3

Set Up Mode

    Automatic exit from 3-5

    Entry into 3-1

    Exit from 3-5

Set Up Parameters All At default

    Indication of 3-1

**T**

Time Elapsed

    Operator Mode display 2-2

    Resetting (from front panel)  
        2-2

    Resetting (via comms. link)  
        4-8



$\frac{1}{8}$ -DIN DIGITAL INDICATOR  
PRODUCT MANUAL  
VOLUME II  
INSTALLATION AND  
CONFIGURATION INSTRUCTIONS



The procedures described in this volume must be undertaken by technically competent servicing personnel.

## **Contents**

1	INSTALLATION	1-1
2	INTERNAL LINKS AND SWITCHES	2-1
3	CONFIGURATION MODE	3-1

## **Appendices**

A	PRODUCT SPECIFICATION	A-1
B	ALPHABETICAL INDEX	B-1



## SECTION 1 INSTALLATION

### 1.1 UNPACKING PROCEDURE

1. Remove the instrument from its packing. The instrument is supplied with a panel gasket and push-fit fixing strap. Retain the packing for future use, should it be necessary to transport the instrument to a different site or to return it to the supplier for repair/testing.
2. Examine the delivered items for damage or deficiencies. If any is found, notify the carrier immediately.

### 1.2 PANEL-MOUNTING

The panel on which the instrument is to be mounted must be rigid and may be up to 6.0mm (0.25 inches) thick. The cut-out required for a single Digital Indicator is as shown in Figure 1-1.

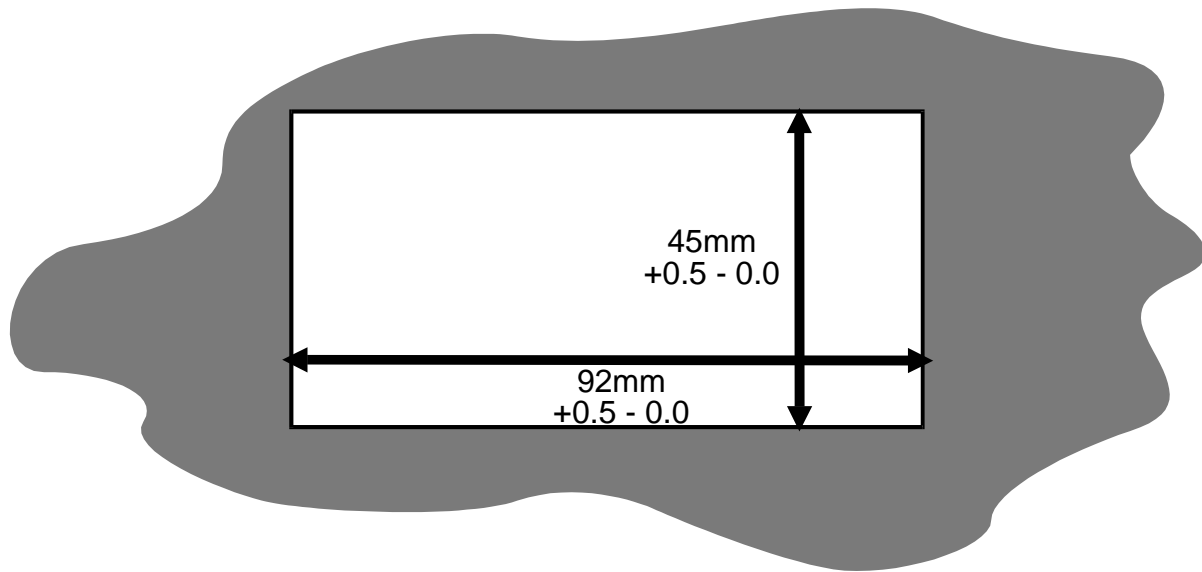

Figure 1-1 Cut-out Dimensions

The Digital Indicator is 100mm deep (measured from the rear face of the front panel). The front panel is 48mm high and 96mm wide. When panel-mounted, the front panel projects 10mm from the mounting panel. The main dimensions of the instrument are shown in Figure 1-2.

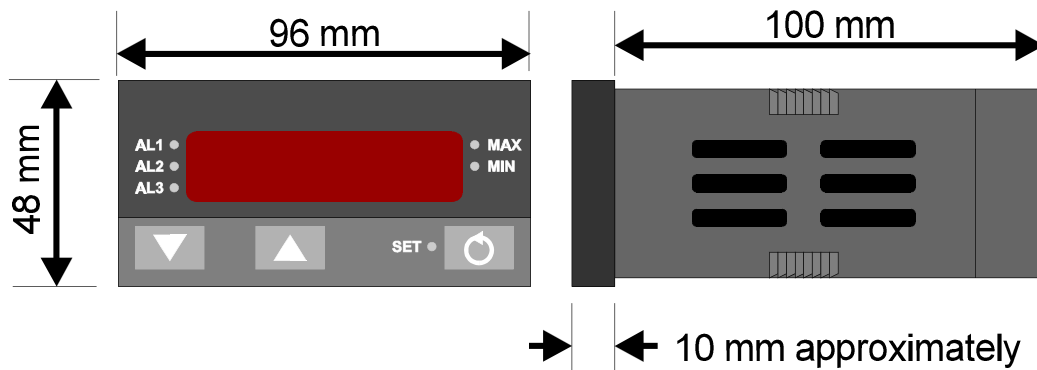

Figure 1-2 Main Dimensions

To panel-mount the instrument:

1. Insert the rear of the housing through the cut-out (from the front of the mounting panel) and hold the instrument lightly in position against the panel. Ensure that the panel gasket is not distorted and that the instrument is positioned squarely against the mounting panel. *Apply pressure to the front panel bezel only.*

**CAUTION:** Do not remove the panel gasket, as this may result in inadequate clamping of the instrument in the panel.

2. Slide the fixing strap in place (see Figure 1-3) and push it forward until it is firmly in contact with the rear face of the mounting panel (the tongues on the strap should have engaged in matching ratchet positions on the housing and the fixing strap springs should be pushing firmly against the mounting panel rear face).

Once the instrument is installed in its mounting panel, it may be subsequently removed from its housing, if necessary, as described in Subsection 2.1.

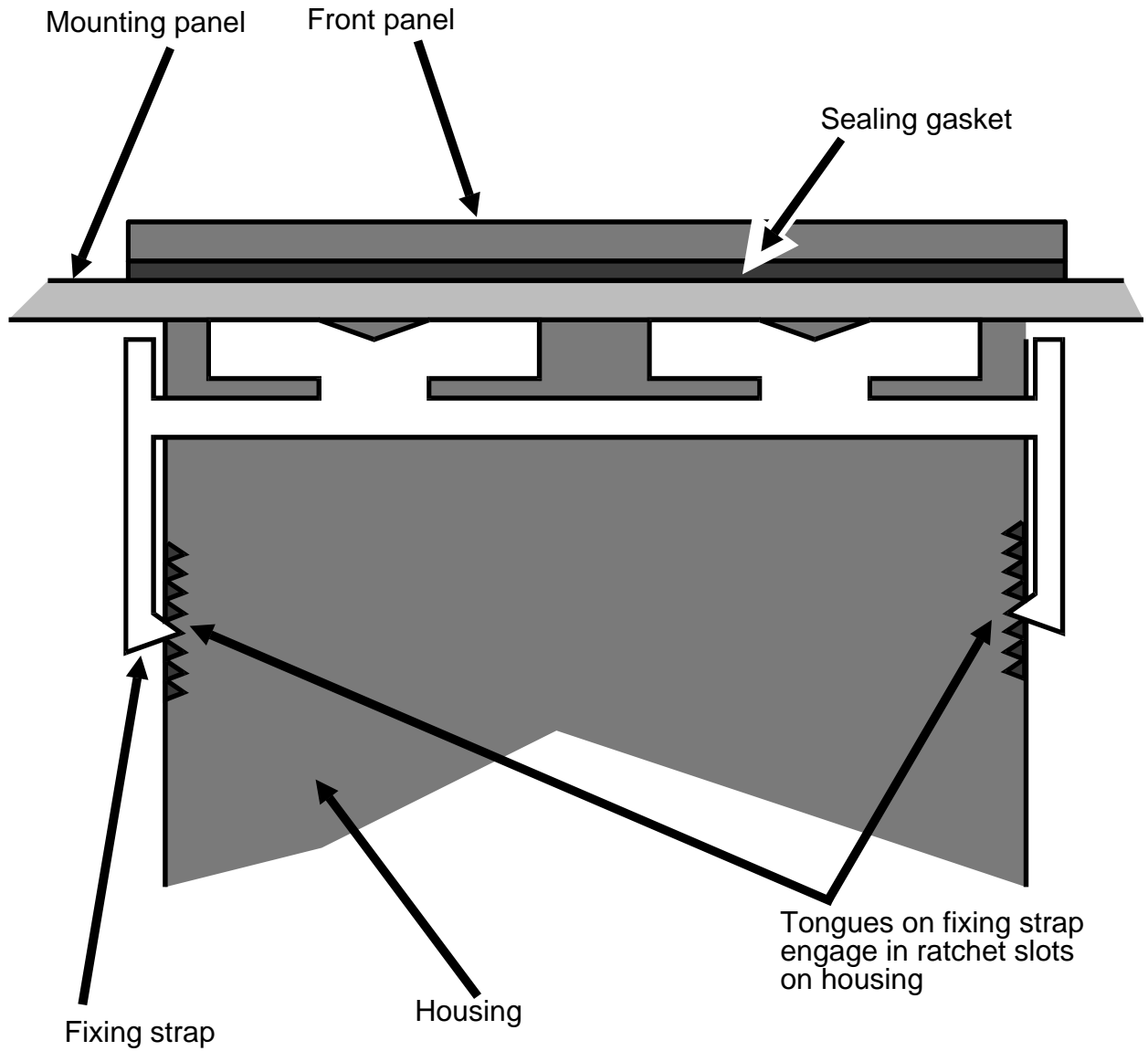

TOP VIEW OF INSTRUMENT

Figure 1-3 Panel-Mounting

### 1.3 CONNECTIONS AND WIRING

The rear terminal connections are illustrated in Figure 1-4.

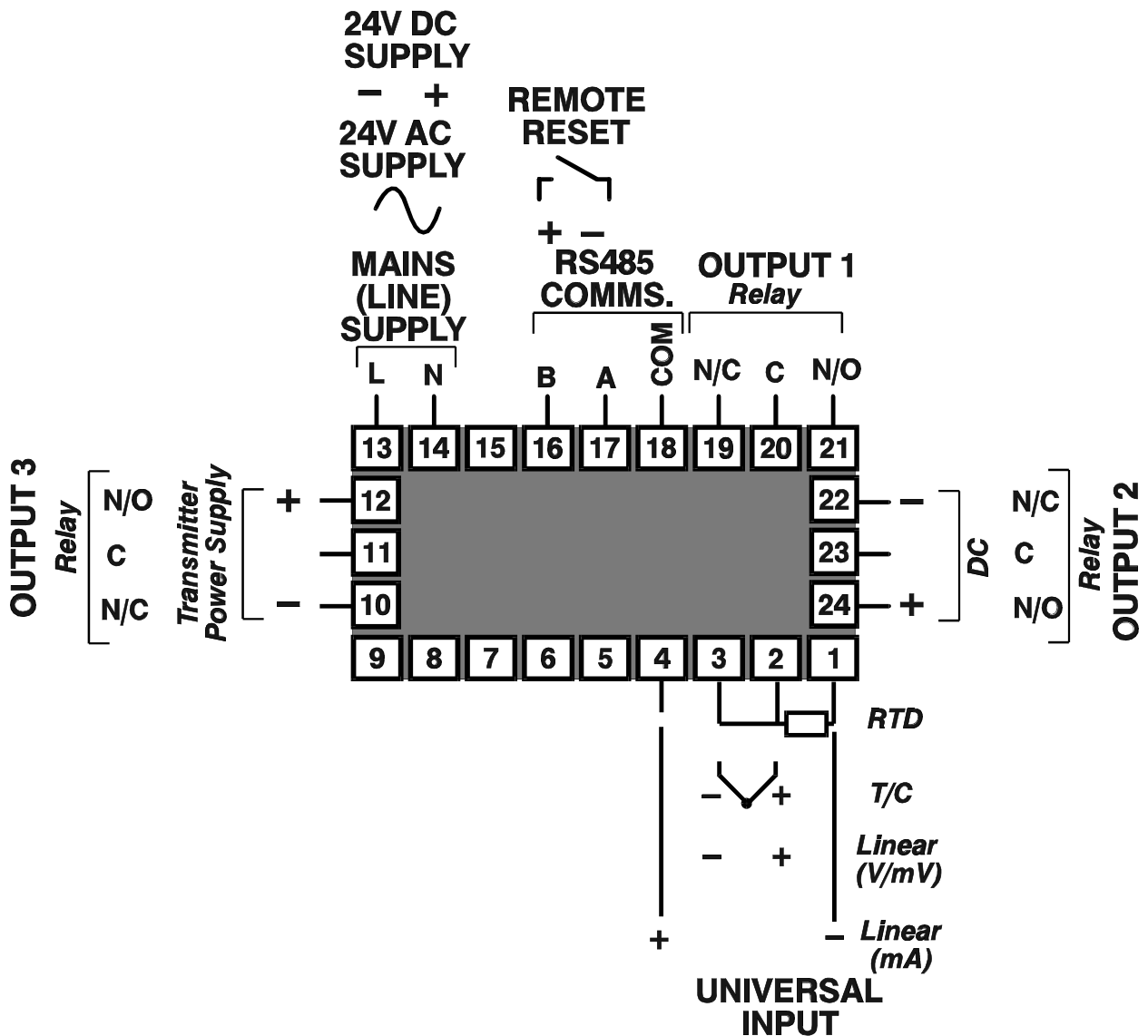

- Output 1** is always a relay output which may be used as Alarm 1 (latching or non-latching) or the logical OR of Alarms 1 & 2.
- Output 2** (option) may be a relay output (Alarm 2, Alarm 3 or logical OR of Alarms 1 & 2, 1 & 3 or 2 & 3) or a DC output (recorder output)
- Output 3** (option) may be a relay output (Alarm 2, Alarm 3 or logical OR of Alarms 1 & 2, 1 & 3 or 2 & 3) or a transmitter power supply output

Figure 1-4 Rear Terminal Connections

### 1.3.1 Mains (Line) Input

The instrument will operate on 96 - 264V AC 50/60Hz mains (line) supply. The power consumption is approximately 4 VA.

**CAUTION:** This equipment is designed for installation in an enclosure which provides adequate protection against electric shock. Local regulations regarding electrical installation should be rigidly observed. Consideration should be given to prevention of access to the power terminations by unauthorised personnel. Power should be connected via a two-pole isolating switch (preferably situated near the equipment) and a 1A fuse, as shown in Figure 1-5.

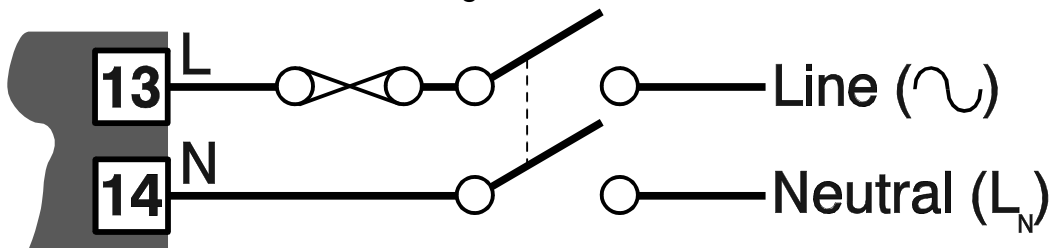

Figure 1-5 Mains (Line) Supply Connections

If the instrument has relay outputs in which the contacts are to carry mains (line) voltage, it is recommended that the relay contact mains (line) supply should be switched and fused in a similar manner but should be separate from the instrument mains (line) supply.

### 1.3.2 24V (Nominal) AC/DC Supply

The supply connections for the 24V AC/DC version are shown in Figure 1-6. Power should be connected via a two-pole isolating switch and a 315mA slow-blow fuse (anti-surge Type T).

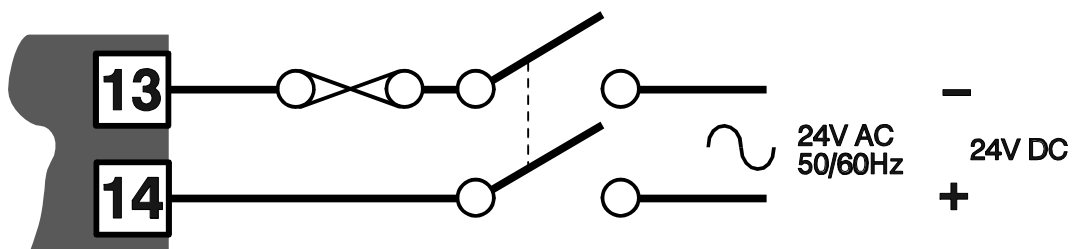

Figure 1-6 24V AC/DC Supply Connections

The nominal 24V supply may be in the following ranges:

24V (nominal) AC 50/60Hz -	20 - 50V
24V (nominal) DC -	22 - 65V

Table 1-1 Thermocouple Cable Colour Codes

Thermocouple Type	Cable Material	British			
		(BS1843: 1952)	(BS4937: Part 30: 1993)	American (ASTM)	German (DIN)
T	Copper Constantan	+ White - Blue * Blue	+ Brown - White * Brown	+ Blue - Red * Blue	+ Red - Brown * Brown
J	Iron/Constantan	+ Yellow - Blue * Black	+ Black - White * Black	+ White - Red * Black	+ Red - Blue * Blue
K	Nickel Chromium Nickel Aluminium	+ Brown - Blue * Red	+ Green - White * Green	+ Yellow - Red * Yellow	+ Red - Green * Green
R S	13% Copper 10% Copper Nickel	+ White - Blue * Green	+ Orange - White * Orange	+ Black - Red * Green	+ Red - White * White
B	Platinum/Rhodium		+ Grey - White * Grey	+ Grey - Red * Grey	

\* Colour of overall sheath.

### 1.3.3 Thermocouple Input

The correct type of thermocouple extension leadwire/compensating cable must be used for the entire distance between the instrument and the thermocouple, ensuring that correct polarity is observed throughout. Joints in the cable should be avoided, if possible. The CJC facility must be enabled (normal conditions) for this input (see Subsection 3.10).

NOTE: Do not run thermocouple cables adjacent to power-carrying conductors. If the wiring is run in a conduit, use a separate conduit for the thermocouple wiring. If the thermocouple is grounded, this must be done at one point only. If the thermocouple extension lead is shielded, the shield must be grounded at one point only.

The colour codes used on thermocouple extension leads are shown in Table 1-1.

### 1.3.4 RTD Input

The compensating lead should be connected to Terminal 3. For two-wire RTD inputs, Terminals 2 and 3 should be linked. The extension leads should be of copper and the resistance of the wires connecting the resistance element should not exceed 5 ohms per lead (the leads should be of equal length).

### 1.3.5 Linear Input

For linear mA input ranges, connection is made to Terminals 1 and 4 in the polarity shown in Figure 1-4. For linear mV and V ranges, connection is made to Terminals 2 and 3 in the polarity shown in Figure 1-4. For details of the linear input ranges available, refer to Appendix A. If it is required to display the engineering units used, refer to Subsection 2.4.

### 1.3.6 Remote Reset (Option)

With the Remote Reset option fitted, Terminals 16 and 17 may be connected to an external switch/relay contacts or to a TTL-compatible logic signal, which is used to reset the latched Alarm 1. For an external switch/relay contacts, an "open-closed" transition will reset the latched alarm. For a TTL signal, a "Logic 1 - Logic 0" transition will reset the latched alarm.

TTL levels:	Logic 1	>2.0V
	Logic 0	<0.8V

NOTE: The Remote Reset option and the RS485 Serial Communications option are mutually exclusive.

See also Subsection 3.3.2 and Appendix A.

### 1.3.7 Relay Output

The contacts are rated at 2A resistive at 120/240V AC.

### 1.3.8 DC Output

See Appendix A.

### **1.3.9 RS485 Serial Communications (Option)**

The connections for the three-wire RS485 serial communications option (if fitted) are on Terminals 16, 17 and 18, as shown in Figure 1-4. Where several instruments are connected to one master port, the master port transceiver in the active state should be capable of driving a load of 12k $\Omega$  per instrument; the master port transceiver in the passive state must have pull-up/pull-down resistors of sufficiently low impedance to ensure that it remains in the quiescent state whilst supplying up to  $\pm 100\mu\text{A}$  each to the instrument's transceivers in the high impedance state.



## SECTION 2 INTERNAL LINKS AND SWITCHES

### 2.1 REMOVING THE INSTRUMENT FROM ITS HOUSING

To withdraw the instrument from its housing, simply grip the side edges of the front panel (there is a finger grip on each edge) and pull the instrument forwards. This will release the instrument from its rear connectors in the housing and will give access to the PCBs. Take note of the orientation of the instrument for subsequent replacement into the housing. The positions of the PCBs in the instrument are shown in Figure 2-1.

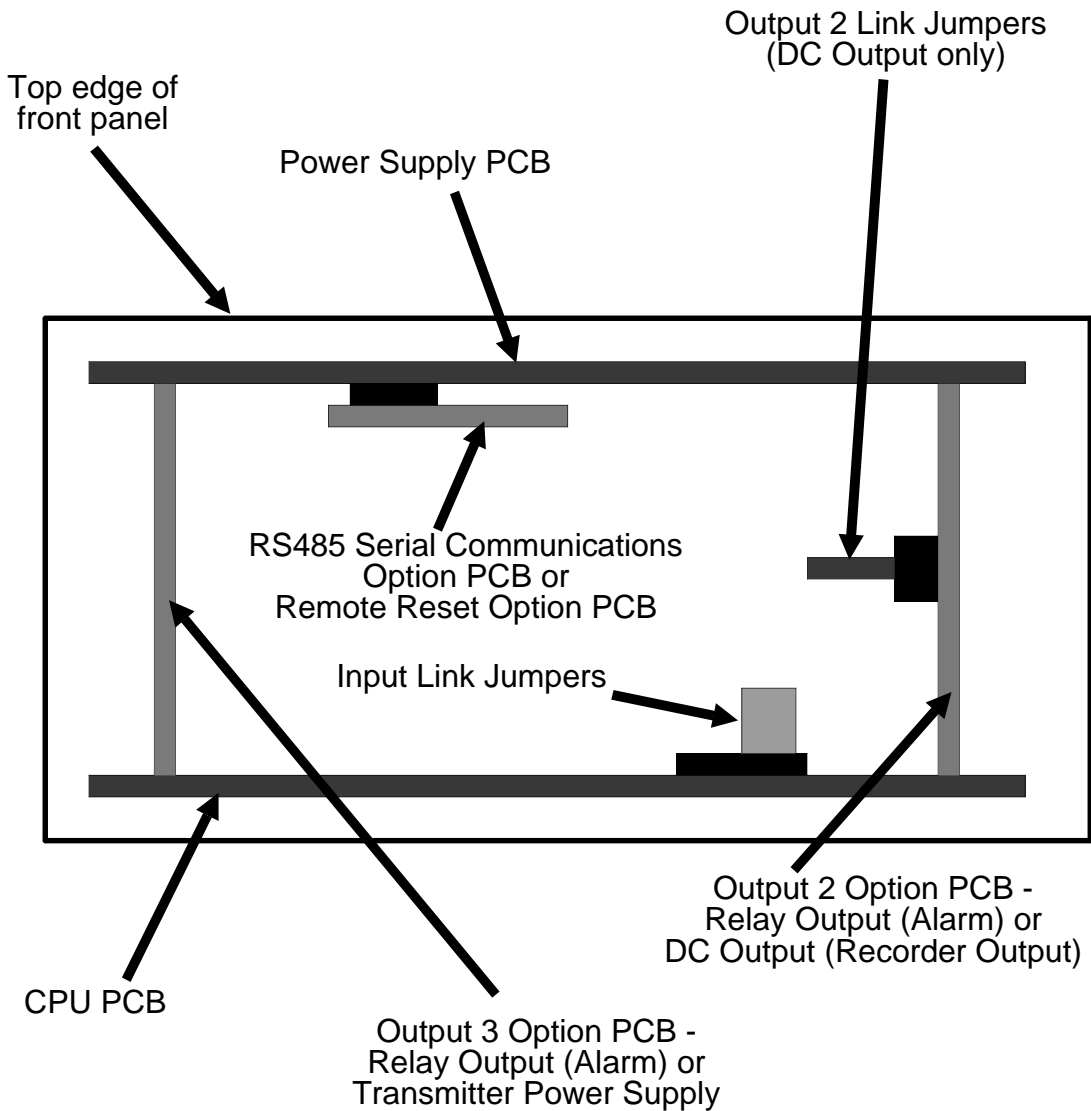

REAR VIEW OF UNHOUSED INSTRUMENT

Figure 2-1 PCB Positions

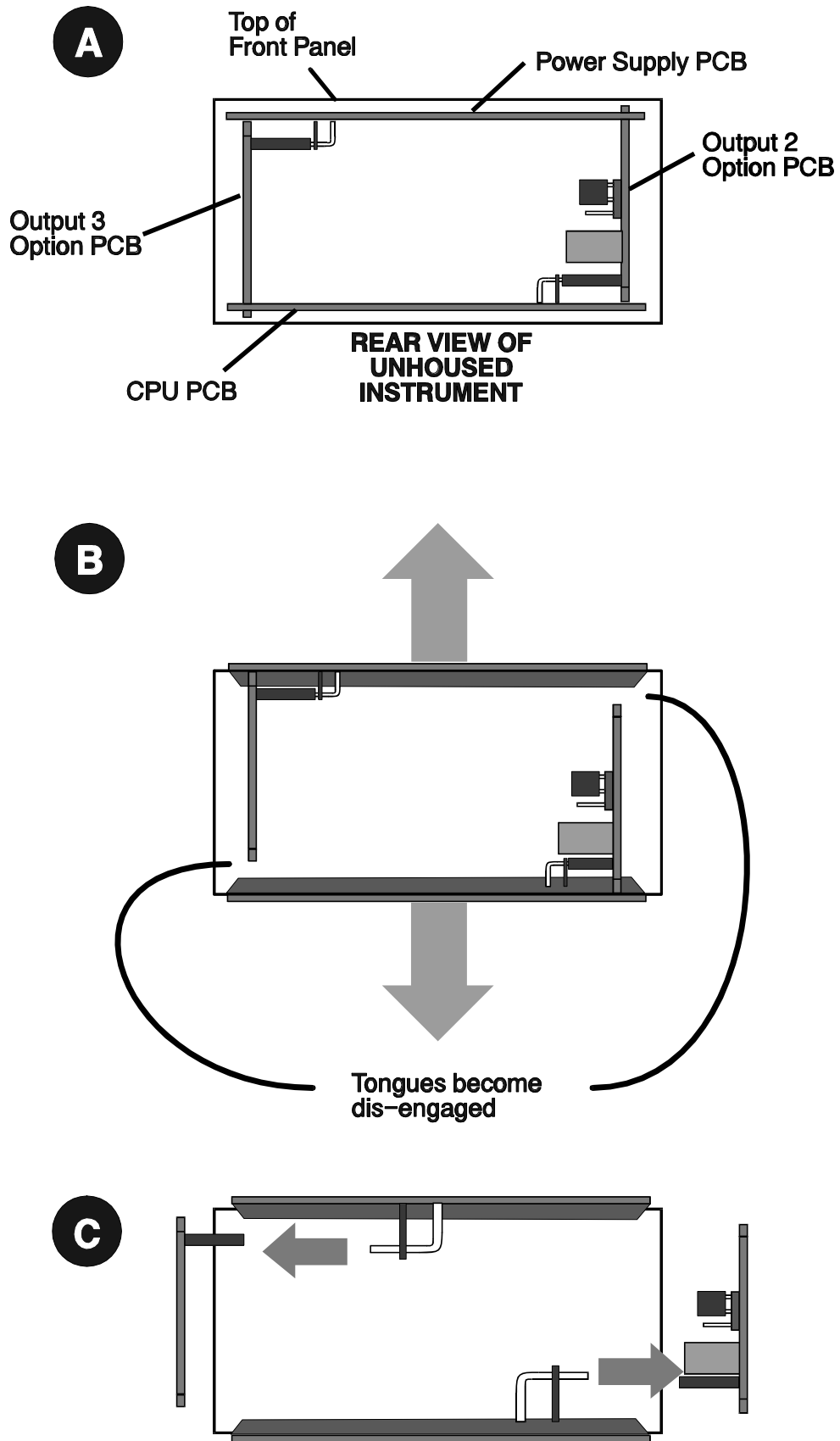

Figure 2-2 Removing the Output 2/Output 3 Option PCBs

## 2.2 REMOVING/REPLACING THE OUTPUT 2/OUTPUT 3 OPTION PCBs

With the instrument removed from its housing:

1. Gently push the rear ends of the CPU PCB and Power Supply PCB apart slightly, until the two tongues on each of the Output 2/Output 3 Option PCBs become dis-engaged - see Figure 2-2B; The Output 2 Option PCB tongues engage in holes in the Power Supply PCB and the Output 3 Option PCB tongues engage in holes on the CPU PCB.
2. Carefully pull the required Option PCB (Output 2 or Output 3) from its connector (Output 2 Option PCB is connected to the CPU PCB and Output 3 Option PCB is connected to the Power Supply PCB) - see Figure 2-2C. Note the orientation of the PCB in preparation for its replacement.

Adjustments may now be made to the link jumpers on the CPU PCB and (if DC output) the Output 2 PCB. The replacement procedure is a simple reversal of the removal procedure.

## 2.3 REMOVING/REPLACING THE RS485 COMMUNICATIONS OPTION PCB OR REMOTE RESET OPTION PCB

The RS485 Communications Option PCB or Remote Reset Option PCB is mounted on the inner surface of the Power Supply PCB and can be removed when the instrument is removed from its housing (see Subsection 2.1) by pulling the Option PCB towards the rear of the PSU PCB. Figure 2-3 illustrates the removal/replacement procedure. *It is not necessary to remove the Output 2/Output 3 Option PCBs to perform this procedure.*

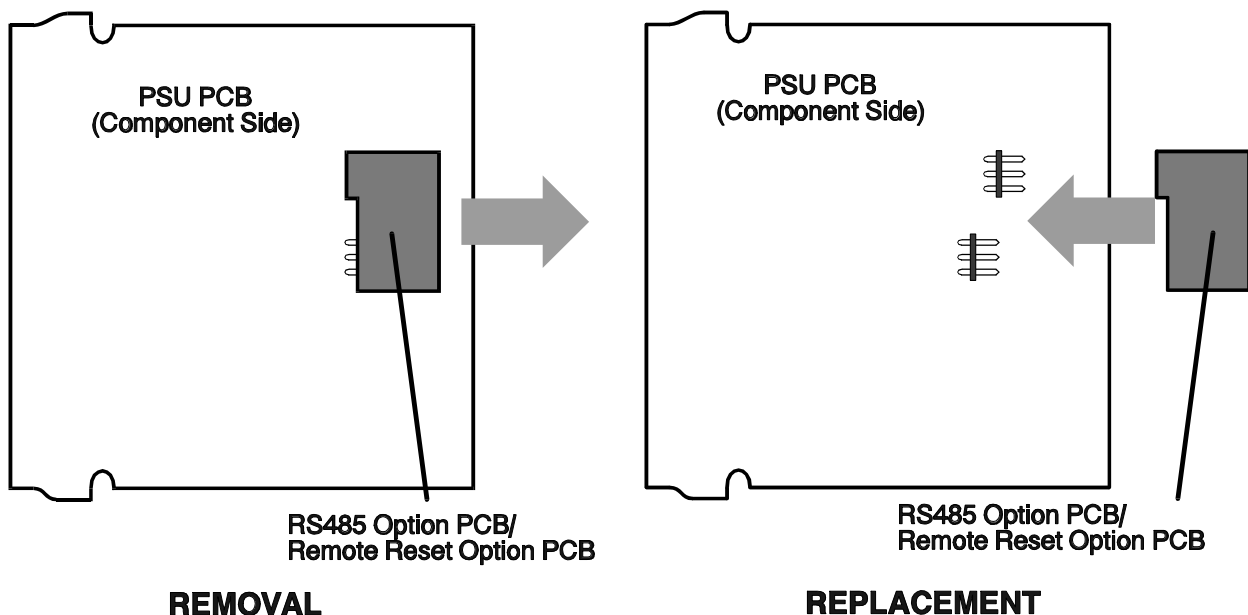

Figure 2-3 Removing/Replacing the RS485 Option PCB or Remote Reset Option PCB

## 2.4 INSTALLING THE ENGINEERING UNIT LABEL

The instrument is equipped with a label carrier (see Figure 2-4) to which a self-adhesive engineering unit label may be attached if required.

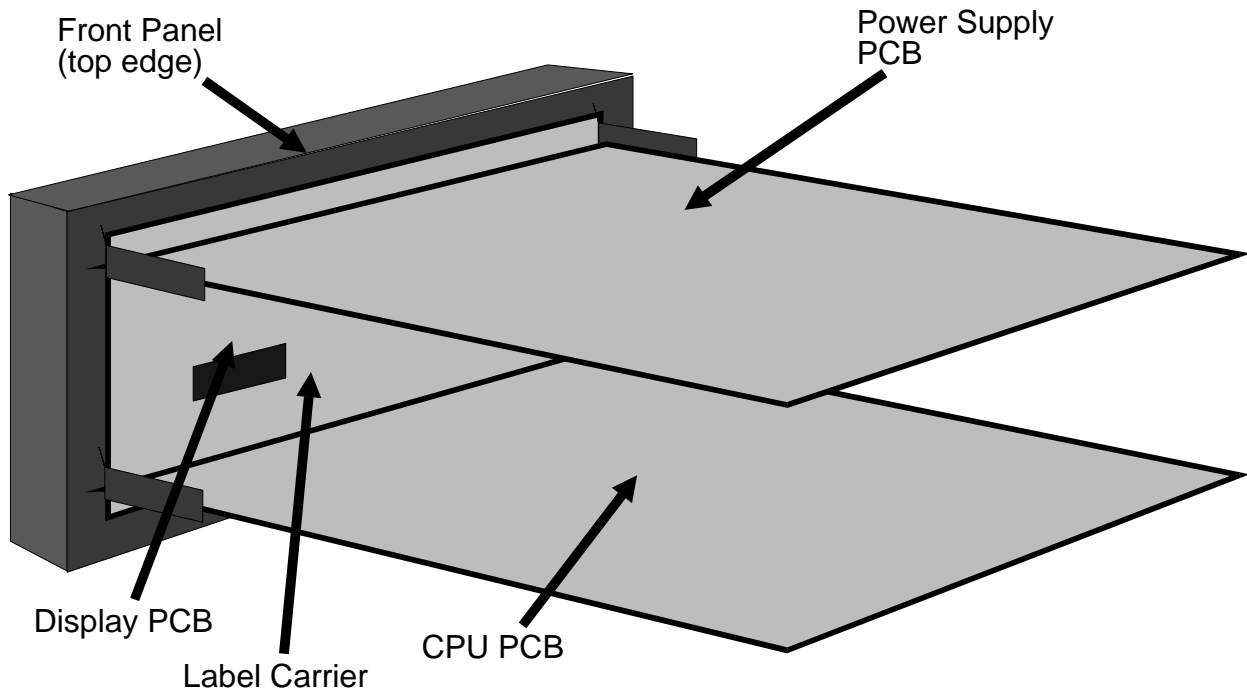

Figure 2-4 Location of Label Carrier

If the instrument is configured with a linear input and engineering units are to be displayed on the front panel, the required unit label (see sheet of peel-off labels at the rear of this manual) may be installed as follows:

1. Remove the instrument from its housing (see Subsection 2.1).
2. For the CPU PCB and Power Supply PCB simultaneously, gently bend one retaining arm (see Figure 2-5A) to free one side of each PCB; swing the PCBs clear of the front panel and carefully move them away from the front panel (the CPU PCB will still be connected to the front panel/Display PCB by a ribbon cable - *do not stress this ribbon cable*).
3. Remove the label carrier from its aperture in the Display PCB (see Figure 2-5B).
4. Remove the required engineering unit label from the peel-off sheet at the rear of this manual and affix to the front face of the label carrier (see Figure 2-5C), using the ledge on the front face of the carrier for alignment.
5. Replace the label carrier in its aperture on the Display PCB.
6. Replace the CPU PCB and Power Supply PCB in position at the rear of the front panel.
7. Replace the instrument in its housing (see Subsection 2.5).

NOTE: Spare label carriers (Part No. 18633) and engineering label sheets (Part No. 84107) are available.

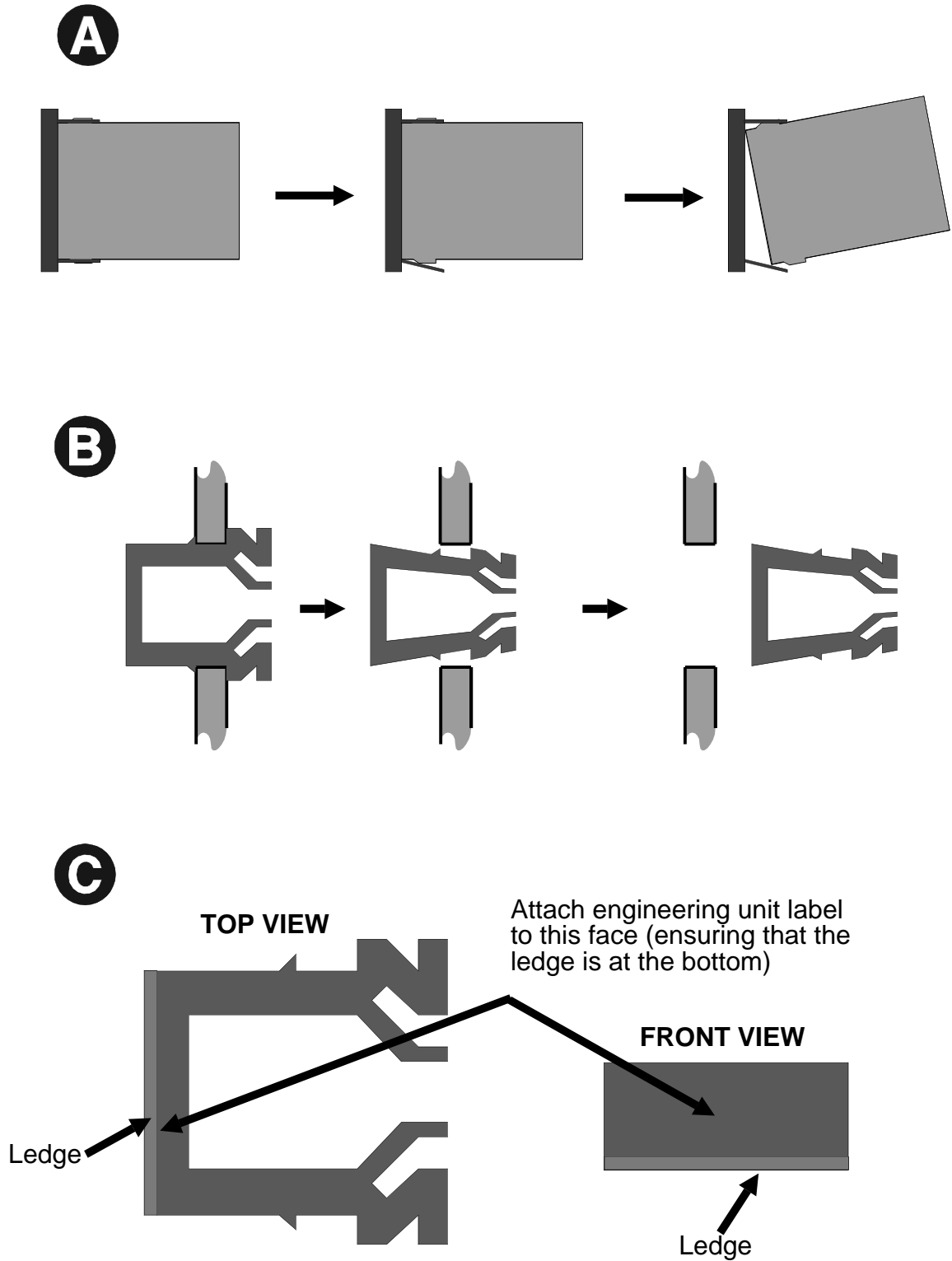

Figure 2-5 Installing the Engineering Unit Label

## 2.5 REPLACING THE INSTRUMENT IN ITS HOUSING

To replace the instrument, simply align the CPU PCB and Power Supply PCB with their guides and connectors in the housing and slowly but firmly push the instrument into position.

**CAUTION:** Ensure that the instrument is correctly orientated. A stop will operate if an attempt is made to insert the instrument in the wrong orientation (e.g. upside-down). *This stop must not be over-ridden.*

## 2.6 SELECTION OF INPUT TYPE

The required input type is selected on link jumpers LJ1/LJ2/LJ3 on the CPU PCB (see Figure 2-6 and Table 2-1).

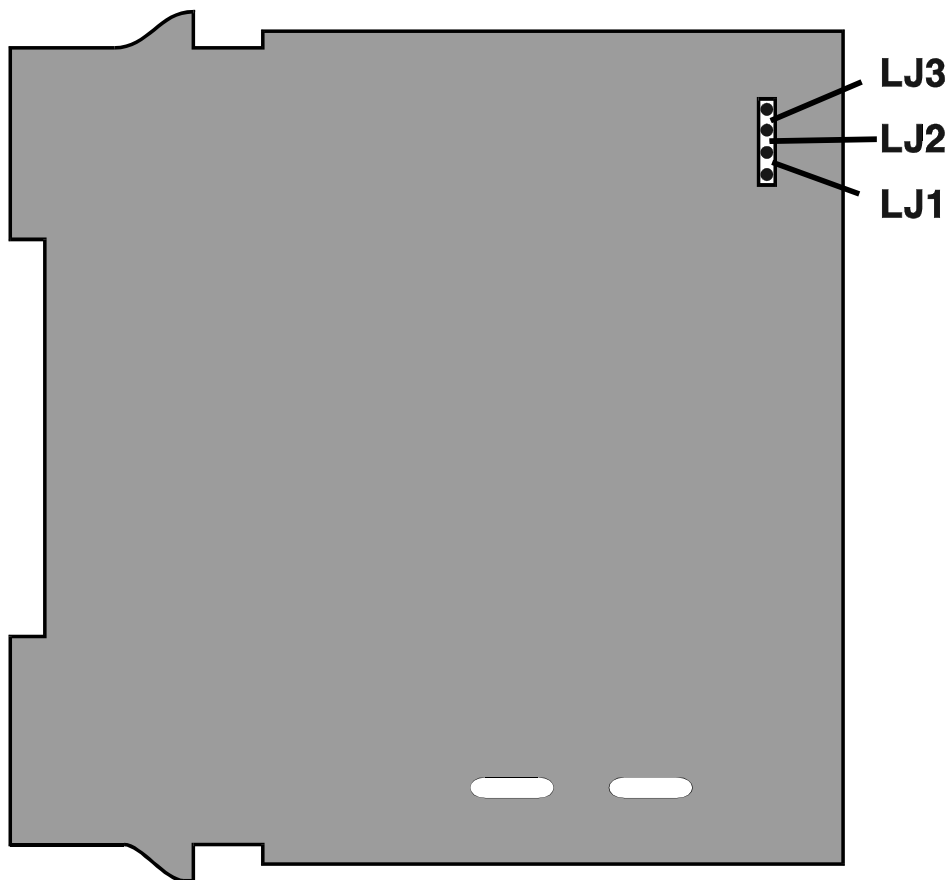

Figure 2-6 CPU PCB Link Jumpers

Table 2-1 Input Type Selection

Input Type	CPU PCB Link Jumper Fitted)
RTD or DC (mV)	None (Parked)
Thermocouple	LJ3
DC (mA)	LJ2
DC (V)	LJ1

## 2.7 OUTPUT 2 TYPE/OUTPUT 3 TYPE

The type of output for Output 2 and Output 3 is determined by the Option PCB fitted in the appropriate position (see Figure 2-1) and, in the case of the DC Output 2 Option PCB being fitted, the setting of Link Jumpers LJ8 and LJ9 on that Option PCB (see Figure 2-7 and Table 2-2). There are three types of option PCB:

1. Relay Output Option PCB (no link jumpers) - Output 2 and Output 3
2. DC Output Option PCB (link jumpers as in Figure 2-7 and Table 2-2) - Output 2 only
3. Transmitter Power Supply Option PCB - Output 3 only

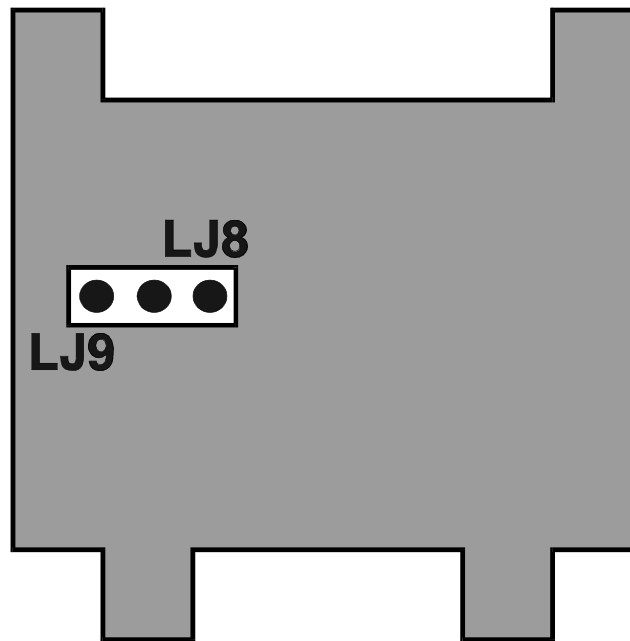

Figure 2-7 DC Output 2 Option PCB

Table 2-2 DC Output 2 Type Selection

Output Type	Link Jumpers Fitted
DC (0 - 10V)	LJ8 (DC Output 2 Option PCB)
DC (0 - 20mA)	LJ9 (DC Output 2 Option PCB)
DC (0 - 5V)	LJ8 (DC Output 2 Option PCB)
DC (4 - 20mA)	LJ9 (DC Output 2 Option PCB)

## SECTION 3 CONFIGURATION MODE

### 3.1 ENTRY INTO CONFIGURATION MODE

To enter Configuration Mode:

1. Ensure that the instrument is powered-down.
2. Power-up the instrument and, within ten minutes of power-up, hold down the Raise and Scroll keys simultaneously for six seconds. If this is done whilst the instrument is displaying the process variable value, the instrument will enter/exit Set Up Mode - *keep holding the keys down!*

NOTE: This need not be the first key action after power-up.

The instrument will then enter Configuration Mode and the **SET** indicator will flash. The user will then be presented with the first of a sequence of parameter displays; in each instance, the parameter will be identified by a single-character legend in the units display and the setting of that parameter will be shown in the four-digit display. The user may then step through the parameters using the Scroll key. The setting may be adjusted using the Raise/Lower keys. As soon as the value/setting is changed, the four-digit display will flash, indicating that the new value/setting has yet to be confirmed (this flashing is inhibited during actual adjustment). When the value/setting is as required, it may be confirmed by:

- (a) pressing the Scroll key, whereupon the four-digit display will show:



- (b) pressing the Raise key.

The four-digit display will then show a static (non-flashing) display of the new parameter setting. Depression of any key other than the Raise key at the **SurE?** display will cause the original parameter setting to be retained. The sequence of parameter displays is shown in Table 3-1.

NOTE: Changes to the value/setting of certain Configuration Mode parameters (e.g. input range, output use and type) will cause the Set Up Mode parameters to be automatically set to their default values the next time Set Up Mode is entered (see also Volume 1, start of Section 3). It is recommended that *all* Configuration Mode parameters are finalised *before* Set Up Mode parameters are adjusted.



Table 3-1 Configuration Mode Parameters



























Parameter	Legend	Available Settings	Default
Hardware Definition Code		See Subsection 3.2	2100
Hardware Option fitted		 None fitted	
		 RS485 Communications	
		 Remote Latch Reset	
Input Range		Defined by Input Code (see Subsection 3.4)	1419
Alarm 1 Type	AL1 ON	 Process High Alarm	
		 Process Low Alarm	
Alarm 2 Type	AL2 ON	 Not in use	
		 Process High Alarm	
		 Process Low Alarm	
Alarm 3 Type	AL3 ON	 Not in use	
		 Process High Alarm	
		 Process Low Alarm	
Output 1 Use		 Alarm 1, non-latching, direct-acting	
		 Alarm 1, non-latching, reverse-acting	
		 Alarm 1, latching, direct-acting	
		 Alarm 1, latching, reverse-acting	
		 Logical OR of Alarm 1 and Alarm 2, direct-acting	
		 Logical OR of Alarm 1 and Alarm 2, reverse-acting	

Table 3-1 (Cont.) Configuration Mode Parameters























Parameter	Legend	Available Settings	Default
Output 2 Use <sup>1</sup>		 Alarm 2, direct-acting <sup>5</sup>	
		 Alarm 2, reverse-acting <sup>5</sup>	
		 Alarm 3, direct-acting <sup>5</sup>	
		 Alarm 3, reverse-acting <sup>5</sup>	
		 Logical OR of Alarm 1 and Alarm 2, direct-acting <sup>5</sup>	
		 Logical OR of Alarm 1 and Alarm 2, reverse-acting <sup>5</sup>	
		 Logical OR of Alarm 1 and Alarm 3, direct-acting <sup>5</sup>	
		 Logical OR of Alarm 1 and Alarm 3, reverse-acting <sup>5</sup>	
		 Logical OR of Alarm 2 and Alarm 3, direct-acting <sup>5</sup>	
		 Logical OR of Alarm 2 and Alarm 3, reverse-acting <sup>5</sup>	
Output 3 Use <sup>2</sup>		 Recorder Output (PV) <sup>6</sup>	
		 Alarm 2, direct-acting <sup>7</sup>	
		 Alarm 2, reverse-acting <sup>7</sup>	
		 Alarm 3, direct-acting <sup>7</sup>	
		 Alarm 3, reverse-acting <sup>7</sup>	
		 Logical OR of Alarm 1 and Alarm 2, direct-acting <sup>7</sup>	
		 Logical OR of Alarm 1 and Alarm 2, reverse-acting <sup>7</sup>	
		 Logical OR of Alarm 1 and Alarm 3, direct-acting <sup>7</sup>	

Table 3-1 (Cont.) Configuration Mode Parameters

Parameter	Legend	Available Settings	Default
Output 3 Use (cont.) <sup>2</sup>		Logical OR of Alarm 1 and Alarm 3, reverse-acting <sup>7</sup>	
		Logical OR of Alarm 2 and Alarm 3, direct-acting <sup>7</sup>	
		Logical OR of Alarm 2 and Alarm 3, reverse-acting <sup>7</sup>	
		Transmitter Power Supply <sup>8</sup>	
Communications Baud Rate <sup>3</sup>		1200, 2400, 4800 or 9600 Baud	4800
Communications Address <sup>3</sup>		1 - 32	1
Communications Protocol <sup>3</sup>		ASCII	
		MODBUS, odd parity	
		MODBUS, even parity	
		MODBUS, no parity	
Cold Junction Compensation Enable/Disable <sup>4</sup>		Enabled	
		Disabled	

## NOTES ON TABLE 3-1

1. Only appears in display sequence if Output 2 is fitted/configured in the Hardware Definition Code (i.e. Digit 3 is non-zero).
2. Only appears in display sequence if Output 3 is fitted/configured in the Hardware Definition Code (i.e. Digit 4 is non-zero).
3. Only appears in display sequence if the Hardware Option parameter is set to **r485**.
4. Only appears in display sequence if thermocouple input is fitted/configured i.e. Digit 1 of Hardware Definition Code is set to 2 (see Subsection 3.2)
5. Only if Output 2 is configured as a relay output
6. Only if Output 2 is configured as a DC linear output
7. Only if Output 3 is configured as a relay output
8. Only if Output 3 is configured as a transmitter power supply output

### 3.2 HARDWARE DEFINITION CODE

This parameter is used to represent the hardware fitted (input type, Output 1 type, Output 2 type and Output 3 type); this must be compatible with the hardware actually fitted. Access to the Hardware Definition Code is gained by pressing the Scroll and Lower keys simultaneously whilst the instrument is in Configuration Mode. The code is used as follows:

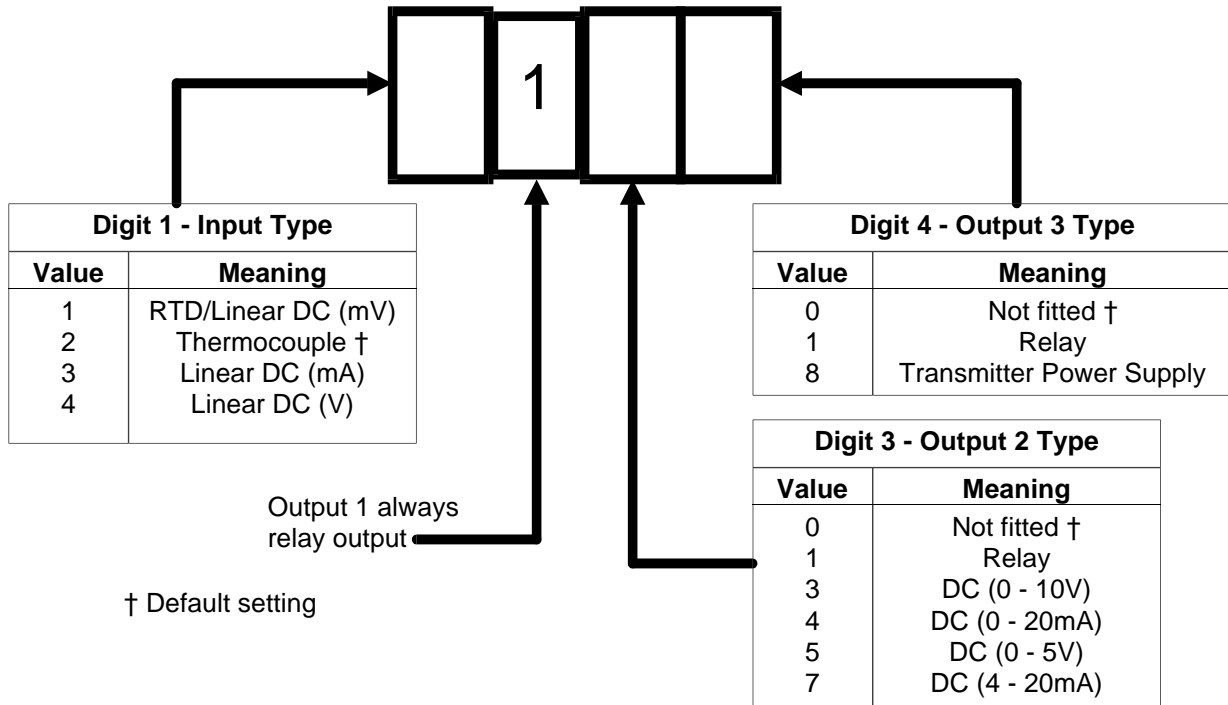

The maximum setting available for this code is 4178. For example, the code for an instrument with a thermocouple input, relay Output 1, relay Output 2 and relay Output 3 would be 2111.

NOTE: It is essential that this code is changed promptly whenever there is a change to the instrument's hardware configuration (change of input/output type, alarm/recorder output added/removed etc.). The instrument software depends upon this code to ensure correct operation.

This code may also be viewed as a Read Only display in Operator Mode (see Volume 1, Subsection 2.9).

### 3.3 HARDWARE OPTION

There are two hardware options available - RS485 Serial Communications and Remote Latching Alarm Reset. These options are mutually exclusive. Access is gained to the Hardware Option parameter by pressing the Scroll key whilst the Hardware Definition Code is displayed in Configuration Mode. The Hardware Option display may be viewed as a Read Only display in Operator Mode (see Volume 1, Subsection 2.9)

### 3.3.1 RS485 Serial Communications Option

For this option, the protocol used is defined by the **Communications Protocol** parameter - see Subsection 3.9. Full details of communications operation are given in Volume 1, Section 4.

### 3.3.2 Remote Latching Alarm Reset Option

This option has the same effect as resetting the latching Alarm 1 (see **Output 1 Use** parameter in Table 3-1) from the front panel. *The latched Alarm 1 can be reset only if the original alarm condition has been cleared; this reset has no effect whilst the alarm condition prevails.* See also Appendix A for more details of this option.

## 3.4 INPUT RANGE

The default setting of this parameter is dependent upon the input hardware fitted, as indicated by the first (left-most) digit of the Hardware Definition Code (see Subsection 3.2):

Input Hardware Fitted	Default Setting
Thermocouple	1419 (Type "J", 0 to 761°C)
RTD/Linear mV)	7220 (RTD Pt100, 0 to 800°C)
Linear mA	3414 (4 to 20mA)
Linear V	4446 (0 to 10V)

If the Hardware Definition Code is at its default setting, input code 1419 will be displayed. The input ranges and codes available are listed in Appendix A.

## 3.5 ALARM TYPE

The operation of the different alarm types is shown in Volume 1, Figure 3-1.

## 3.6 LOGICAL COMBINATION OF ALARMS

Output 1, 2 or 3 may be used as a relay output representing a logic OR of two alarms.

### EXAMPLE OF LOGICAL COMBINATION OF ALARMS

Logical OR of Alarm 1 with Alarm 2

Alarm Status		Relay State	
Alarm 1	Alarm 2	Direct-acting	Reverse-acting
OFF	OFF	De-energised	Energised
ON	OFF	Energised	De-energised
OFF	ON	Energised	De-energised
ON	ON	Energised	De-energised

## 3.7 COMMUNICATIONS BAUD RATE

This parameter must be set to the same Baud rate as the communications port on the master device.

### 3.8 COMMUNICATIONS ADDRESS

This is the unique address assigned to the instrument; it is used by the master device to communicate with the instrument.

### 3.9 COMMUNICATIONS PROTOCOL

There are two communications protocols available: ASCII (fixed, even parity) and MODBUS (selectable odd parity, even parity or no parity). Refer to Volume 1, Section 4 for details.

### 3.10 COLD JUNCTION COMPENSATION

This parameter is applicable only if a thermocouple input is fitted, in which case it must be enabled in normal use.

NOTE: If a thermocouple input is fitted and the CJC is disabled, in Operator Mode whenever the process variable is displayed, the unit display will show:



### 3.11 EXIT FROM CONFIGURATION MODE

To leave Configuration Mode, either (a) press the Raise and Scroll keys simultaneously or (b) power-down then power up again. Either action will cause a return to the Operator Mode.

NOTE: An automatic return to Operator Mode is made if, in Configuration Mode, there is no front panel key activity for five minutes.

The exit is made via the power-up self-test routines which include an LED indicator test.

## APPENDIX A

### PRODUCT SPECIFICATION

#### UNIVERSAL INPUT

##### General

Maximum per Instrument:	One
Input Sample Rate:	Four samples/second
Digital Input Filter:	Time constant selectable from front panel - 0.0 (i.e. OFF), 0.5 to 100.0 seconds in 0.5-second increments.
Input Resolution:	14 bits approximately; always four times better than display resolution.
Input Impedance:	Greater than 100M $\Omega$ resistive (except for DC mA and V inputs).
Isolation:	Isolated from all outputs at 240V AC.
Process Variable Offset:	Adjustable (input span).

##### Thermocouple

Ranges selectable from front panel:

Type	Input Range	Displayed Code	Type	Input Range	Displayed Code
R	0 - 1650°C	1127	K	-200 - 760°C	6726
R	32 - 3002°F	1128	K	-328 - 1399°F	6727
S	0 - 1649°C	1227	K	-200 - 1373°C	6709
S	32 - 3000°F	1228	K	-328 - 2503°F	6710
J	0.0 - 205.4°C	1415	L	0.0 - 205.7°C	1815
J	32.0 - 401.7°F	1416	L	32.0 - 402.2°F	1816
J	0 - 450°C	1417	L	0 - 450°C	1817
J	32 - 842°F	1418	L	32 - 841°F	1818
J	0 - 761°C *	1419	L	0 - 762°C	1819
J	32 - 1401°F	1420	L	32 - 1403°F	1820
T	-200 - 262°C	1525	B	211 - 3315°F	1934
T	-328 - 503°F	1526	B	100 - 1824°C	1938
T	0.0 - 260.6°C	1541	N	0 - 1399°C	5371
T	32.0 - 501.0°F	1542	N	32 - 2550°F	5324

\* Default setting

Calibration: Complies with BS4937, NBS125 and IEC584.

Sensor Break Protection: Break detected within two seconds. Alarms operate as if the process variable has gone over-range.

### Resistance Temperature Detector (RTD)

Ranges selectable from front panel:

Input Range	Displayed Code	Input Range	Displayed Code	Input Range	Displayed Code
0 - 800°C *	7220	-149.7 - 211.9°F	2231	-200 - 206°C	2297
32 - 1471°F	7221	0 - 300°C	2251	-328 - 402°F	2298
32 - 571°F	2229	0.0 - 100.9°C	2295	-100.9 - 537.3°C	7222
-100.9 - 100.0°C	2230	32.0 - 213.6°F	2296	-149.7 - 999.1°F	7223

\* Default setting

Type and Connection: Three-wire Pt100  
 Calibration: Complies with BS1904 and DIN43760.  
 Lead Compensation: Automatic scheme.  
 RTD Sensor Current: 150 $\mu$ A (approximately)  
 Sensor Break Protection: Break detected within two seconds. Alarms operate as if the process variable has gone over-range.

### DC Linear

Ranges Selectable from Front Panel:

Input Range	Displayed Code	Input Range	Displayed Code	Input Range	Displayed Code	Input Range	Displayed Code
0 - 20mA	3413	0 - 50mV	4443	0 - 5V	4445	0 - 10V*	4446
4 - 20mA*	3414	10 - 50mV	4499	1 - 5V	4434	2 - 10V	4450

\* Default setting

(Changes may also be required to the CPU PCB link jumpers - see Subsection 7.4.1.)

Scale Range Maximum: -1999 to 9999. Decimal point as required.

Scale Range Minimum: -1999 to 9999. Decimal point as for Scale Range Maximum.

Minimum Span: 1 display LSD.



Sensor Break Protection: Applicable to 4 - 20mA, 1 - 5V and 2 - 10V ranges only. Break detected within two seconds. Alarms operate as if the process variable has gone under-range.

### REMOTE RESET INPUT (Option)

Type: Voltage-free, TTL-compatible

May be connected to: External switch/relay contacts or TTL-compatible logic signal.

Reset caused by: Open-close transition (external switch/relay contacts) or "1" - "0" logic transition (TTL logic signal).

Maximum Input Delay (open - closed or "1" - "0"): 1 second

Minimum Input delay (closed - open or "0" - "1"): 1 second

### External switch/relay contacts:

Maximum Contact Resistance (Closure): 50 $\Omega$

Minimum Contact Resistance (Open): 5000 $\Omega$

### External TTL Logic Signal:

Maximum Voltage (TTL) for "0": 0.8V

Minimum Voltage (TTL) for "0": -0.6V

Minimum Voltage (TTL) for "1": 2.0V

Maximum Voltage (TTL) for "1": 24.0V

## OUTPUT 1

### General

Type: Relay.

Contact Type: Single pole double throw (SPDT).

Rating: 2A resistive at 120/240V AC.

Lifetime: >500,000 operations at rated voltage/current.

Isolation: Inherent.

## OUTPUT 2 (Option)

### General

Types Available: Relay and DC.

### Relay

Contact Type: Single pole double throw (SPDT).

Rating: 2A resistive at 120/240V AC.

Lifetime: >500,000 operations at rated voltage/current.

Isolation: Inherent.

### DC

Resolution: Eight bits in 250mS (10 bits in 1 second typical, >10 bits in >1 second typical).

Update Rate: Approximately 4/second.

Ranges: 0 - 20mA, 4 - 20mA, 0 - 10V, 0 - 5V, 1 - 5V, 2 - 10V

(Changes between V and mA ranges also require link jumper movement.)

Load Impedance: 0 - 20mA: 500 $\Omega$  maximum  
4 - 20mA: 500 $\Omega$  maximum  
0 - 10V: 500 $\Omega$  minimum  
0 - 5V: 500 $\Omega$  minimum  
1 - 5V: 500 $\Omega$  minimum  
2 - 10V: 500 $\Omega$  minimum

Isolation: Isolated from all other inputs and outputs.

Range Selection Method: Link jumper and front panel code.

## OUTPUT 3 (Option)

### General

Types Available: Relay and Transmitter Power Supply

### Relay

Contact Type: Single pole double throw (SPDT).

Rating: 2A resistive at 120/240V AC.

Lifetime: >500,000 operations at rated voltage/current.

Isolation: Inherent.

**Transmitter Power Supply**

Output:	20 - 28V DC (24V DC nominal).
Minimum Load Impedance:	910 $\Omega$ (22mA @ 20V DC).

**ALARM CONTROL**

Maximum Number of Alarms:	Three
Max. No. of Outputs Available:	All three outputs can be alarm outputs.
Combinatorial Alarms:	Logical OR of alarms to an individual hardware output is available.

**COMMUNICATIONS**

Type:	Serial asynchronous UART-to-UART link.
Data Format:	ASCII: One start bit, even parity, seven data bits, one stop bit. MODBUS: as above with odd, even or no parity
Physical Layer:	RS485
Presentation Layer:	ASCII or MODBUS
Maximum Number of Zones:	32
Baud Rate:	Selectable from 9600, 4800, 2400 or 1200 Baud.
Zone Address Selection:	Selectable from front panel in the range 1 - 32.

**PERFORMANCE****Reference Conditions**

Generally as BS5558.

Ambient Temperature:	20°C $\pm$ 2°C
Relative Humidity:	60 - 70%
Supply Voltage:	90 - 264V AC 50Hz $\pm$ 1%
Source Resistance:	<10 $\Omega$ for thermocouple input
Lead Resistance:	<0.1 $\Omega$ /lead balanced (Pt100)

**Performance Under Reference Conditions**

Common Mode Rejection:	>120dB at 50/60Hz giving negligible effect at up to 264V 50/60Hz.
------------------------	---

Series Mode Rejection: >500% of span (at 50/60Hz) causes negligible effect.

#### DC Linear Inputs

Measurement Accuracy:  $\pm 0.05\%$  of span  $\pm 1$ LSD.

#### Thermocouple Inputs

Measurement Accuracy:  $\pm 0.25\%$  of span  $\pm 1$ LSD. NOTE: Reduced performance with Type "B" Thermocouple between 100 - 600°C (212 - 1112°F).

Linearisation Accuracy: Better than  $\pm 0.2^\circ\text{C}$  any point, any  $0.1^\circ\text{C}$  range ( $\pm 0.05^\circ\text{C}$  typical). Better than  $\pm 0.5^\circ\text{C}$  any point, any  $1^\circ\text{C}$  range.

Cold Junction Compensation: Better than  $\pm 0.7^\circ\text{C}$ .

#### RTD Inputs

Measurement Accuracy:  $\pm 0.25\%$  of span  $\pm 1$ LSD

Linearisation Accuracy: Better than  $\pm 0.2^\circ\text{C}$  any point, any  $0.1^\circ\text{C}$  range ( $\pm 0.05^\circ\text{C}$  typical). Better than  $\pm 0.5^\circ\text{C}$  any point, any  $1^\circ\text{C}$  range.

#### DC Output 2 (Recorder Output)

Accuracy:  $\pm 0.25\%$  (mA @ 250 $\Omega$ , V @ 2k $\Omega$ ); Degrades linearly to  $\pm 0.5\%$  for increasing burden (to specification limits). Degrades to  $\pm 4\%$  in the frequency band 52 - 80MHz for line-conducted disturbances induced by RF fields (10V 80% AM 1kHz).

#### Operating Conditions

Ambient Temperature (Operating):  $0^\circ\text{C}$  to  $55^\circ\text{C}$

Ambient Temperature (Storage):  $-20^\circ\text{C}$  to  $80^\circ\text{C}$

Relative Humidity: 20% - 95% non-condensing

Supply Voltage: 90 - 264V AC 50/60Hz (standard)  
20 - 50V AC 50/60Hz or 22 - 65V DC (option)

Source Resistance: 1000 $\Omega$  maximum (thermocouple)

Lead Resistance: 50 $\Omega$  per lead maximum balanced  
(Pt100)

### Performance Under Operating Conditions

Temperature Stability: 0.01% of span/ $^{\circ}$ C change in ambient temperature.

Cold Junction Compensation (thermocouple Only): Better than  $\pm 1^{\circ}$ C.

Supply Voltage Influence: Negligible.

Relative Humidity Influence: Negligible

Sensor Resistance Influence: Thermocouple 100 $\Omega$ : <0.1% of span error  
Thermocouple 1000 $\Omega$ : <0.5% of span error  
RTD Pt100 50 $\Omega$ /lead: <0.5% of span error

### ENVIRONMENTAL

Operating Conditions: See **PERFORMANCE**.

EMI Susceptibility: Designed to meet EN50082 Part 2.

EMI Emissions: Designed to meet EN500081 Part 2.

Safety Considerations: Designed to comply with IEC 1010-1 in as far as it is applicable.

Supply Voltage: 90 - 264V AC 50/60Hz (standard)  
20 - 50V AC 50/60Hz or 22 - 65V DC (option)

Power Consumption: 4 watts approximately.

Front Panel Sealing: To IP65 (similar to NEMA 4)

### PHYSICAL

Dimensions: Depth - 100mm approximately  
Front Panel:  
Width - 48mm, Height - 96mm ( $\frac{1}{8}$ -DIN)

Mounting: Plug-in with panel mounting fixing strap.  
Panel cut-out 45mm x 92mm.

Terminals: Screw type (combination head) plus "telecom" type socket.

Weight: 0.48kg (1.06lb) maximum

## Alphabetical Index

### A

- AC/DC (24V) Supply
  - Fuse rating 1-5
  - Terminal connections 1-5
  - Voltage ranges 1-5
- Alarm Type
  - Selection of 3-6

### C

- CJC Disabled Display
  - Thermocouple inputs only 3-7
- Cold Junction Compensation
  - Enabling/disabling 3-7
- Communications
  - Baud rate, selection of 3-6
  - Terminal connections 1-8
- Communications Address
  - Selection of 3-7
- Communications Option
  - Selection of 3-6
- Communications Option PCB
  - Removal/replacement 2-3
- Communications Protocol
  - Selection of 3-7
- Configuration Mode
  - Automatic exit from 3-7
  - Entry into 3-1
  - Exit from 3-7
- CPU PCB
  - Link jumpers 2-6

### D

- DC Linear Input
  - Ranges available A-2
- DC Output
  - Terminal connections 1-7

### E

- Engineering Unit Label
  - Installing 2-4

### H

- Hardware Definition Code
  - Explanation of 3-5
  - Viewing/changing 3-5
- Hardware Option Setting
  - Viewing/changing 3-5

### I

- Input Range
  - Selection of 3-6
- Input Type
  - Selection of 2-6
- Instrument Dimensions A-7

### L

- Label Carrier
  - Location of 2-4
- Linear Input
  - Terminal connections 1-7
- Logical Combination of Alarms
  - Example of 3-6

**M**

Mains (Line) Input	
Fuse rating	1-5
Terminal connections	1-5
Voltage range	1-5

**O**

Output 2 DC Option PCB	
Link jumpers	2-7
Output 2 Option PCB	
Removal/replacement	2-3
Output 2 Type	
Selection of	2-7
Output 3 Option PCB	
Removal/replacement	2-3
Output 3 Type	
Selection of	2-7

**P**

Panel-Mounting	
Cut-out dimensions	1-1
Indicator dimensions	1-1
Maximum panel thickness	1-1
Procedure	1-2
PCB Positions	2-1
Power Consumption	1-5

**R**

Rear Terminal Connections	1-4
Relay Output	
Terminal connections	1-7
Remote Reset Input	
Terminal connections	1-7

Remote Reset Option	
Selection of	3-6
Remote Reset Option PCB	
Removal/replacement	2-3
Removing the Indicator from its Housing	2-1
Replacing the Indicator in its Housing	2-6
RTD Input	
Ranges available	A-2
Terminal connections	1-7

**S**

Sensor Break	
Effect on Alarm outputs (DC linear inputs)	A-3
Effect on Alarm outputs (RTD inputs)	A-2
Effect on Alarm outputs (thermocouple inputs)	A-2

**T**

Thermocouple Input	
Ranges available	A-1
Terminal connections	1-7

**U**

Unpacking Procedure	1-1
---------------------	-----

