

# SHIMPO INSTRUMENTS

## Model DT-205L Handheld LCD Digital Laser Tachometer

## Instruction Manual



Congratulations on your purchase of a Shimpo DT-205L digital laser tachometer! We trust you will enjoy many years of professional results from your Shimpo tachometer.

Please read the entire instruction manual thoroughly before initial set-up and operation; the information contained herein will aid you in operating your Shimpo tachometer safely and with excellent results.

If you have any questions regarding our product(s), call your local Shimpo representative or contact Shimpo Instruments directly for assistance.

### Inspection/Standard Accessories

If upon delivery shipping damage is detected, do not operate tachometer. Notify shipping carrier immediately for damage claim instructions. Refer to nameplate and record serial number for future reference.

Items included with the DT-205L are:

- Carrying case
- Cone adapter
- 200L adapter
- 6" master wheel
- Reflective tape
- NIST certificate

### Features and Benefits

The Shimpo DT-205L is a battery-operated, microprocessor-controlled, non-contact/contact tachometer that utilizes a laser beam for movement detection. In the non-contact mode a laser beam measures RPM when directed towards a shaft (or any other rotating mechanism marked with a small piece of reflective tape). The included 200L adapter allows for contact measurement via a rubber tip cone attachment or the included 6" master linear wheel.

The DT-205L tachometer incorporates the latest microprocessor and laser technology and offers:

- *Multi-mode capability measures RPM, mPM, YPM, FPM, IPM and total meters, yards, feet and inches*
- *Large memory capacity allows up to 13 measurements to be stored in memory*
- *Single chip microprocessor ensures reliability and low maintenance*
- *Safely measures RPM (non-contact mode) from up to 14 feet away*
- *Oversized 5-digit LCD display permits easy reading*
- *Long battery life (up to 40 hours of continuous use)*
- *Rugged die-cast aluminum housing provides exceptional durability*
- *Extended measuring range (6 - 99,999 rpm) covers wide range of applications*

### Important Safety Instructions



Do not point the laser beam into eyes as permanent eye damage may occur! Shimpo Instruments does not condone usage inconsistent with product's labeling and warning.



When using the 6" master wheel, do not use the extension shaft - the wheel may fly off the shaft and cause damage.



Although the tachometer alone is able to achieve the higher ranges listed in the Range and Accuracy table on page 3, the master wheel has a maximum speed limitation of 5,000 FPM (for safety reasons).

# Display Panel

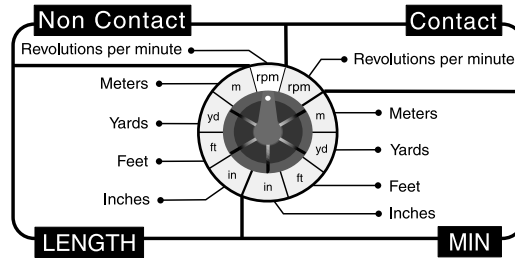

## Operating Procedures

### Non-Contact Measurement

1. Place a small piece of reflective tape (included) on the shaft or moving element (disc, pulley, etc.) whose speed is to be measured. If the element's surface is highly reflective it may need to be painted a darker color in order to ensure reliable results. If the distance to the object is less than 5" (127 mm), reflective tabs (optional) should be used instead of reflective tape.
2. Aim the tachometer at the reflective tape from a distance of 5" (127 mm) to 14' (4.3 m).
3. Press and hold the power switch for several seconds to observe the display as it changes according to the speed of the shaft or rotating element (as soon as the laser hits the reflective tape, the unit will start to indicate the speed). If the beam is "on target" the unit RPM will flash at the top of the display. If RPM is not flashing then the beam is "off target" (adjust aim).
4. After observation is completed, retain the reading by releasing the power switch before removing the tachometer from its position. The last reading is displayed for a period of 5 minutes and can be extended any number of additional 5 minute increments by pressing the memory switch.

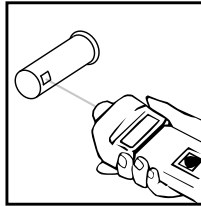

2. Bring cone into contact with the shaft. Apply only enough pressure to avoid slippage.
3. Press and hold the power switch. During engagement the display will reflect the proper RPM while the unit RPM will be flashing above the display digits.
4. Release the power switch prior to removal of tachometer from rotating object to capture the last reading.
5. After release of the power switch, the last reading (with a non-flashing RPM unit) will remain on the display and in memory for 5 minutes, and can be extended any number of additional 5 minute periods by pressing the memory switch.

### Rate & Length Measurement

1. Attach the 6" master wheel and select the desired function using the selector switch located just below the display.
2. Press and hold the power switch; while the wheel is turning and the tachometer is measuring the selected function, the function will be indicated above the digits and will be flashing.
3. Release the power switch before disengaging the tachometer in order to capture the last reading.
4. After release of the power switch, the last, maximum, and minimum readings will be stored in memory for 5 minutes and can be extended any number of additional 5 minute periods by pressing the memory switch.

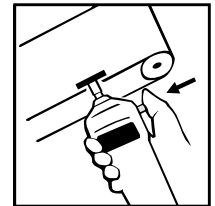

**NOTE:** When switching from the contact to the non-contact mode, the unit RPM will show on the display and also 5 dashes (-----). Press the power switch to cancel the dashes.

### Contact Measurement

For both RPM measurements and non-RPM measurements, screw the 200L adapter (included) into the front of the tachometer.

**NOTE:** Do not use excessive torque when mounting - hand tightening is sufficient



### RPM Measurement

1. Place rubber cone tip on the shaft of the 200L adapter. Make certain that the pin on the shaft is properly aligned with the slot on the cone's sleeve.

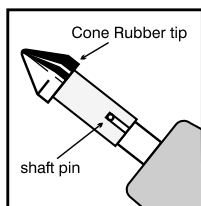

**NOTE:** The memory will clear in 5 minutes after the release of the power switch.

For steps 1-4 described above, it was assumed that the selector switch was in the rate mode region. If the selector switch is moved from the rate mode to the count mode (length), the display will show the selected function (m, ft, yd, or in) and also 5 dashes (-----). Press the power switch to cancel the dashes and start measuring the same way as was described above. Once in the counting mode, the measurement can be stopped at any time and the last reading will be retained for 5 minutes. There is no maximum or minimum reading when in the count (length) mode.

## Memory Recall

### Non-Contact Mode

The following readings are stored in memory for 5 minutes after release of the power switch:

- *Last reading*
- *Maximum reading*
- *Minimum reading*

These readings can be recalled by pressing the memory switch. Ten extra readings can also be captured, stored, then recalled using the memory switch - simply press the memory switch each time a reading needs to be stored while the tachometer is in use.

### Contact Mode (Rate Functions)

When the rate functions are selected (mPM, YPM, FPM and IPM), the memory store and recall functions are accomplished exactly as noted above.

### Contact Mode (Length Functions)

When the counting functions are selected, the memory store and recall functions are accomplished in the same manner as the non-contact mode, the only exception being the maximum and minimum readings (they do not exist).

To clear the memory completely (for all functions), press the memory switch for approximately 6 seconds until the display shows CCCCC, then release the switch.

## Battery Replacement

Low battery voltage is indicated by flashing LOW BAT on the display. Remove end cover by using a coin or appropriate screwdriver and replace both batteries. Please ensure proper polarity.

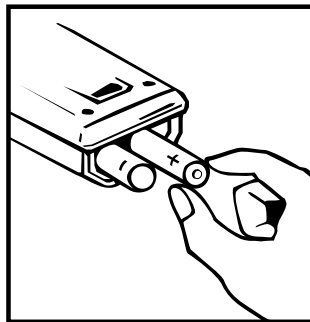
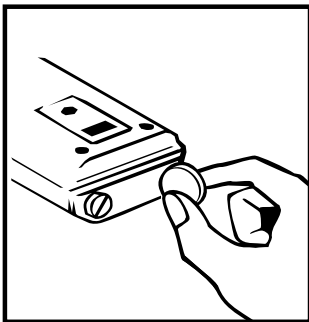

## Range and Accuracy

Place selector switch in the proper position. Using the 200L adapter and 6" master wheel, the following industrial units of measurement are achieved:

MODEL		DT-205L	
R: REVOLUTIONS	SINGLE RANGE	ACCURACY	RESOLUTION
Non-Contact RPM (rev./min.)	6 - 8,300	± 1	1
	8,300 - 25,000	± 2	
	25,000 - 99,999	±0.006% of reading ±1 digit (or ±6 RPM max.)	
Contact RPM (rev./min.)	0.8 - 9,999.9	±0.6%	0.1
	10,000 - 25,000	±0.006% of reading ±1 digit (or ±2 RPM max.)	1
F: FEET	SINGLE RANGE	ACCURACY	RESOLUTION
F/M (feet/min.)	0.4 - 9,999.9	± 0.6	0.1
	10,000 - 12,500	± 1	1
FT (feet)	0.10 - 999.99		0.01
	1,000.0 - 9,999.9		0.1
	10,000 - 99,999		1
Y: YARDS	SINGLE RANGE	ACCURACY	RESOLUTION
Y/M (yards/min.)	0.13 - 999.99	± 0.06	0.01
	1,000.0 - 4,167.0	± 0.3	0.1
YRd (length)	0.02 - 999.99		0.01
	1,000.0 - 9,999.9		0.1
	10,000 - 99,999		1
I: INCHES	SINGLE RANGE	ACCURACY	RESOLUTION
I/M (inches/min.)	5 - 99,999	±0.006% of reading ±1 digit (or ±6 RPM max.)	1
IN (length)	1.0 - 9,999.9		0.1
	10,000 - 99,999		1
m: METERS	SINGLE RANGE	ACCURACY	RESOLUTION
m/M (meters/min.)	0.11 - 999.99	± 0.06	0.01
	1,000.0 - 3,810.0	± 0.3	0.1
m (length)	0.02 - 999.99		0.01
	1,000.0 - 9,999.9		0.1
	10,000 - 99,999		1

**NOTE:** When using the 6" master wheel, accuracy can be affected as much as 0.3% of reading



Although the tachometer alone is able to achieve the above ranges, the master wheel has maximum speed limitation of 5,000 FPM (for safety reasons)

# Troubleshooting

The following are general checkpoints; please call your local Shimpo representative or contact Shimpo Instruments directly for further assistance.

No laser beam is evident:

- Confirm that power switch is functioning
- Confirm that batteries are functioning and that polarity is correct

Inaccurate measurement results:

- If the surface being measured is highly reflective, it may need to be painted a darker color in order to ensure reliable results
- Beam may not be hitting the reflective tape, or taped area may be too small
- Measuring distance may be too short (unit must be at least 5" from intended mark)

# Dimensions and Specifications

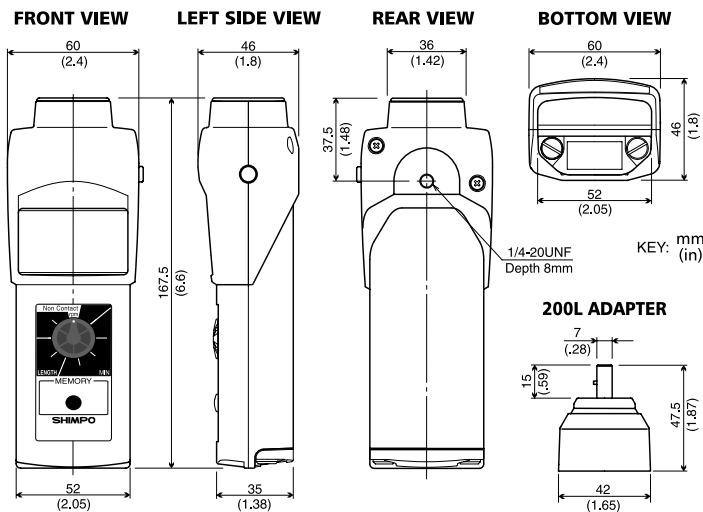

<b>MODEL</b>	<b>DT-205L</b>
<b>Display Range</b>	6 to 99,999 rpm
<b>Accuracy</b>	±1 rpm: 6 to 8,300 rpm ±2 rpm: 8,300 to 25,000 rpm ±0.006% of reading ±1 digit (or ±6 rpm max.): 25,000 to 99,999 rpm
<b>Display</b>	5 digit 0.47" (12mm) high LCD
<b>Measuring Units</b>	RPM (on contact using adapter, included) For YPM, mPM, FPM, IPM and Length: YRD, m, FT and IN use 6" cir. wheel with 200L adapter
<b>Measuring Distance</b>	14' (4.2 m) maximum
<b>Memory System</b>	13 readings are stored in memory and retained for 5 minutes (last, max., min. and 10 extra measurements)
<b>Detection</b>	Laser diode
<b>System Control</b>	Single chip C-MOS microprocessor
<b>Over Range Indicator</b>	Flashing numerals
<b>Update Time</b>	1 second (typical)
<b>Batteries Included</b>	Size: 2 AA 1.5V Life: Approx. 40 hrs
<b>Low Voltage Indicator</b>	Flashing "LO BAT" display
<b>Operating Temperature</b>	32° to 113°F (0° to 45°C)
<b>Construction</b>	Die-cast aluminum housing
<b>Weight</b>	0.8 lb (365g)
<b>Dimensions</b>	6.6"L x 2.4"W x 1.8"H (167 mm x 60 mm x 46 mm)
<b>Warranty</b>	1 year
<b>STANDARD ACCESSORIES</b>	Reflective tape, cone adapter, carrying case, master wheel (6" cir) and 200L adapter

**ISE, Inc.** - 10100 Royalton Rd. - Cleveland, OH 44133 USA - Tel: (440) 237-3200 - Fax: (440) 237-1744 - <http://instserv.com>

# Warranty

**LIMITED EXPRESS WARRANTY:** Shimpo Instruments warrants, to the original purchaser of new products only, that this product shall be free from defects in workmanship and materials under normal use and proper maintenance for one year from the date of original purchase. This warranty shall not be effective if the product has been subject to overload, misuse, negligence, or accident, or if the product has been repaired or altered outside of Shimpo Instruments's authorized control in any respect which in Shimpo Instruments's judgment, adversely affects its condition or operation.

**DISCLAIMER OF ALL OTHER WARRANTIES:** The foregoing warranty constitutes the SOLE AND EXCLUSIVE WARRANTY, and Shimpo Instruments hereby disclaims all other warranties, expressed, statutory or implied, applicable to the product, including, but not limited to all implied warranties of merchantability and fitness.

**LIMITATION OF REMEDY:** Under this warranty, Shimpo Instruments' SOLE OBLIGATION SHALL BE TO REPAIR OR REPLACE the defective product or part, at Shimpo Instruments' option. Shimpo Instruments reserves the right to satisfy warranty obligation in full by reimbursing Buyer for all payments made to Shimpo Instruments, whereupon, title shall pass to Shimpo Instruments upon acceptance of return goods. To obtain warranty service, Purchaser must obtain Shimpo Instruments's authorization before returning the product, properly repackaged, freight pre-paid to Shimpo Instruments.

**INDEMNIFICATION & LIMITATION OF DAMAGES:** Buyer agrees to indemnify and hold Shimpo Instruments harmless from and against all claims and damages imposed upon or incurred arising, directly or indirectly, from Buyer's failure to perform or satisfy any of the terms described herein. In no event shall Shimpo Instruments be liable for injuries of any nature involving the product, including incidental or consequential damages to person or property, any economic loss or loss of use.

**MERGER CLAUSE:** Any statements made by the Seller's representative do not constitute warranties except to the extent that they also appear in writing. This writing constitutes the entire and final expression of the parties' agreement.